



THE DISPLAY CHOICE
OF PROFESSIONALS™

EM2401QC EM2701QC EM3401UQC LCD Monitor

www.agneovo.com

User Manual

TABLE OF CONTENTS

SAFETY INFORMATION

Federal Communications Commission (FCC) Notice (U.S. Only).....	1
WEEE.....	1
Turkey RoHS.....	2
Ukraine RoHS	2

PRECAUTIONS

Notice	3
Cautions When Setting Up.....	3
Cautions When Using.....	4
Cleaning and Maintenance.....	6
Notice for the LCD Monitor.....	6

CHAPTER 1: PRODUCT DESCRIPTION

1.1 Package Contents	6
1.2 Installation	7
1.2.1 Installing the Stand.....	7
1.2.2 Adjusting the Tilt	7
1.3 Overview	9
1.3.1 Front View	9
1.3.2 Control Panel.....	9
1.3.3 Rear View.....	10

CHAPTER 2: MAKING CONNECTIONS

2.1 Making Connections.....	11
-----------------------------	----

CHAPTER 4: ON SCREEN DISPLAY MENU

3.1 OSD Menu Tree	13
-------------------------	----

CHAPTER 6: APPENDIX

4.1 Warning Messages.....	18
4.2 Troubleshooting.....	19

CHAPTER 7: SPECIFICATIONS

5.1 Display Specifications	20
5.2 Display Dimensions.....	21

SAFETY INFORMATION

Federal Communications Commission (FCC) Notice (U.S. Only)



This equipment has been tested and found to comply with the limits for a Class B digital device, pursuant to part 15 of the FCC Rules. These limits are designed to provide reasonable protection against harmful interference in a residential installation. This equipment generates, uses and can radiate radio frequency energy and, if not installed and used in accordance with the instructions, may cause harmful interference to radio communications. However, there is no guarantee that interference will not occur in a particular installation. If this equipment does cause harmful interference to radio or television reception, which can be determined by turning the equipment off and on, the user is encouraged to try to correct the interference by one or more of the following measures:

- Reorient or relocate the receiving antenna.
- Increase the separation between the equipment and receiver.
- Connect the equipment into an outlet on a circuit different from that to which the receiver is connected.
- Consult the dealer or an experienced radio/TV technician for help.

WEEE

Disposal of Waste Equipment by Users in Private Household in the European Union.

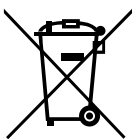

This symbol on the product or on its packaging indicates that this product must not be disposed of with your other household waste. Instead, it is your responsibility to dispose of your waste equipment by handing it over to a designated collection point for the recycling of waste electrical and electronic equipment. The separate collection and recycling of your waste equipment at the time of disposal will help to conserve natural resources and ensure that it is recycled in a manner that protects human health and the environment. For more information about where you can drop off your waste equipment for recycling, please contact your local city office, your household waste disposal service or the shop where you purchased the product.

For Private Households in the European Union. To help conserve natural resources and ensure the product is recycled in a manner that protects human health and the environment, we would like to bring your attention to the following:

- The crossed-out dustbin on the device or outer packaging indicates the product is compliant with European WEEE (Waste Electrical and Electronic Equipment) Directive
- Always dispose of the old devices separately from household waste
- Batteries should be removed beforehand and disposed separately to the right collection system
- You are responsible with regard to the deletion of personal data on old devices before disposal
- Private households can hand in their old devices free of charge
- For more information about where you can drop off your waste equipment for recycling, please contact your local city office, your household waste disposal service or the shop where you purchased the product

SAFETY INFORMATION

Turkey RoHS

Türkiye Cumhuriyeti: EEE Yönetmeliğine Uygundur.

Ukraine RoHS

Обладнання відповідає вимогам Технічного регламенту щодо обмеження використання деяких небезпечних речовин в електричному та електронному обладнанні, затвердженого постановою Кабінету Міністрів України від 3 грудня 2008 № 1057.

PRECAUTIONS

PRECAUTIONS

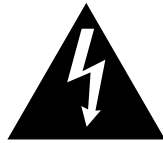

CAUTION
RISK OF ELECTRIC SHOCK
DO NOT OPEN



Symbols used in this manual



This icon indicates the existence of a potential hazard that could result in personal injury or damage to the product.



This icon indicates important operating and servicing information.

Notice

- Read this User Manual carefully before using the LCD monitor and keep it for future reference.
- The products specifications and other information provided in this User Manual are for reference only. All information is subject to change without notice. Updated content can be downloaded from our web site at www.agneovo.com.
- To protect your rights as a consumer, do not remove any stickers from the LCD monitor. Doing so may affect the determination of the warranty period.

Cautions When Setting Up



Do not place the LCD monitor near heat sources, such as a heater, exhaust vent, or in direct sunlight.



Do not cover or block the ventilation holes in the housing.



Place the LCD monitor on a stable area. Do not place the LCD monitor where it may be subject to vibration or shock.



Place the LCD monitor in a well-ventilated area.



Do not place the LCD monitor outdoors.



Do not place the LCD monitor in a dusty or humid environment.



Do not spill liquid or insert sharp objects into the LCD monitor through the ventilation holes. Doing so may cause accidental fire, electric shock or damage the LCD monitor.

PRECAUTIONS

Cautions When Using



Use only the power cord supplied with the LCD monitor.



The power outlet should be installed near the LCD monitor and be easily accessible.



If an extension cord is used with the LCD monitor, ensure that the total current consumption plugged into the power outlet does not exceed the ampere rating.



Do not allow anything to rest on the power cord. Do not place the LCD monitor where the power cord may be stepped on.



If the LCD monitor will not be used for an indefinite period of time, unplug the power cord from the power outlet.



To disconnect the power cord, grasp and pull by the plug head. Do not tug on the cord; doing so may cause fire or electric shock.



Do not unplug or touch the power cord with wet hands.



WARNING:

Unplug the power cord from the power outlet and refer to qualified service personnel under the following conditions:



- When the power cord is damaged.
- If the LCD monitor has been dropped or the housing has been damaged.
- If the LCD monitor emits smoke or a distinct odor.



Ceiling mount or mount on any other horizontal surface overhead are not advisable.



WARNING:

Installation in contravention of the instructions may result in undesirable consequences, particularly hurting people and damaging property. Users who have already mounted the monitor on the ceiling or any other horizontal surface overhead are strongly advised to contact AG Neovo for consultations and solutions to help ensure a most pleasurable and fulfilling monitor experience.

PRECAUTIONS

Cleaning and Maintenance



Do not attempt to service the LCD monitor yourself, refer to qualified service personnel.

Opening or removing the covers may expose you to dangerous voltage or other risks.

Notice for the LCD Monitor

In order to maintain the stable luminous performance, it is recommended to use low brightness setting.

Due to the lifespan of the lamp, it is normal that the brightness quality of the LCD monitor may decrease with time.

When static images are displayed for long periods of time, the image may cause an imprint on the LCD monitor. This is called image retention or burn-in.

To prevent image retention, do any of the following:

- Set the LCD monitor to turn off after a few minutes of being idle.
- Use a screen saver that has moving graphics or a blank white image.
- Switch desktop backgrounds regularly.
- Adjust the LCD monitor to low brightness settings.
- Turn off the LCD monitor when the system is not in use.

Things to do when the LCD monitor shows image retention:

- Turn off the LCD monitor for extended periods of time. It can be several hours or several days.
 - Use a screen saver and run it for extended periods of time.
 - Use a black and white image and run it for extended periods of time.
-

There are millions of micro transistors inside the LCD monitor. It is normal for a few transistors to be damaged and to produce spots. This is acceptable and is not considered a failure.

CHAPTER 1: PRODUCT DESCRIPTION

1.1 Package Contents

When unpacking, check if the following items are included in the package. If any of them is missing or damaged, contact your dealer.

■ LCD Monitor

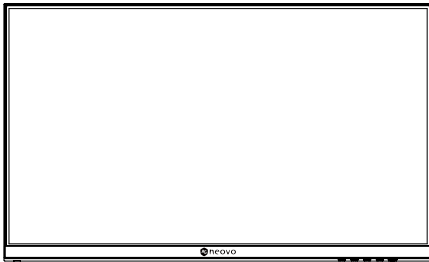

■ Quick Start Guide



■ Power Cord

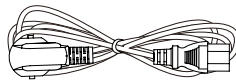

■ Type-C Cable

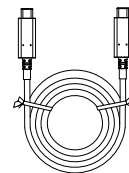

■ HDMI Cable

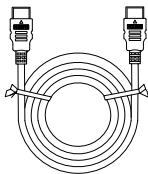

■ Base

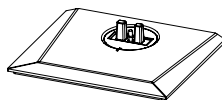

■ Stand



■ Screw Stud

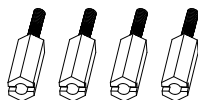

■ Warranty Card

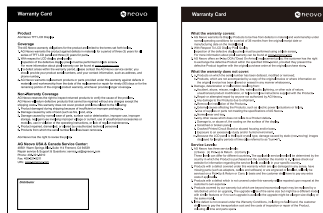

■ Calibration report

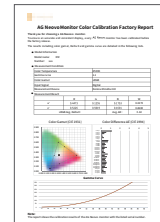

Note:

- Use only the supplied power cord.
- The above pictures are for reference only. Actual items may vary upon shipment.

PRODUCT DESCRIPTION

1.2 Installation

1.2.1 Installing the Stand

1. Take out the stand and base, and lock the stand with the hand screw that comes with the base.
2. Insert the assembled base into the corresponding bayonet of the rear shell, and gently align the tail end perpendicular to the surface of the rear shell, so that the lock of the bracket can be buckled on the quick release button of the rear shell.

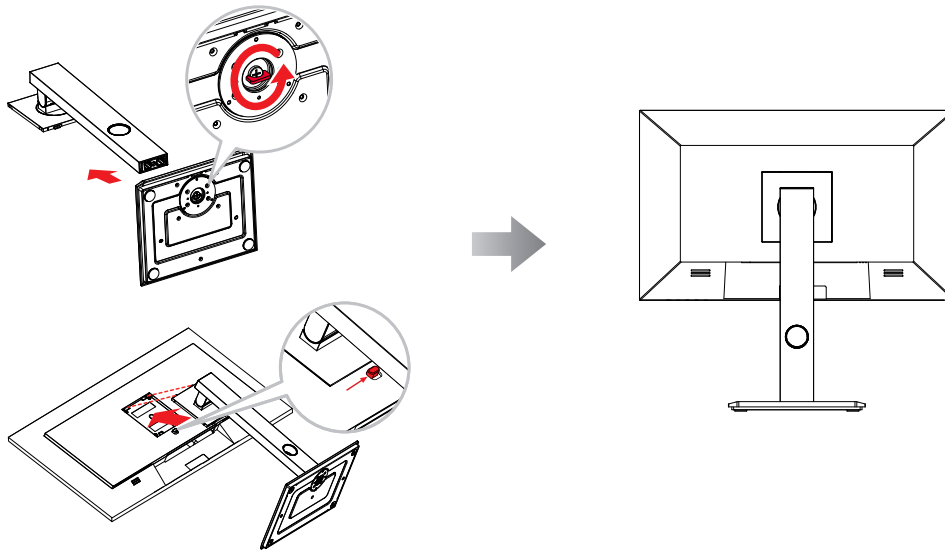

1.2.2 Adjusting the Tilt

The screen can be adjusted by inclining forward and backward; however, the specific adjustment depends on the specific model of the device.

EM2401QC/EM2701QC	<p>The diagram shows four adjustment capabilities for the EM2401QC/EM2701QC model:</p> <ul style="list-style-type: none">Tilting angle: $-5.0^{\circ}(\pm 1.5^{\circ})$ - $+20^{\circ}(\pm 1.5^{\circ})$Height range: 120mm (± 5.0mm)vertical angle: $-90.0^{\circ}(\pm 2.0^{\circ})$ - $+90^{\circ}(\pm 2.0^{\circ})$Rotation angle: $-45.0^{\circ}(\pm 2.0^{\circ})$ - $+45^{\circ}(\pm 2.0^{\circ})$
EM3401UQC	<p>The diagram shows three adjustment capabilities for the EM3401UQC model:</p> <ul style="list-style-type: none">Tilting angle: $-5.0^{\circ}(\pm 1.5^{\circ})$ - $+15^{\circ}(\pm 1.5^{\circ})$Height range: 120mm (± 5.0mm)Rotation angle: $-30.0^{\circ}(\pm 2.0^{\circ})$ - $+30^{\circ}(\pm 2.0^{\circ})$

PRODUCT DESCRIPTION

1.2.3 Wall Mounting

To wall mount the LCD monitor, do the following steps:

1. Remove the base stand.

- Place the LCD monitor with the screen side down on a cushioned surface.
- Push the release button and detach the stand from the base mount.

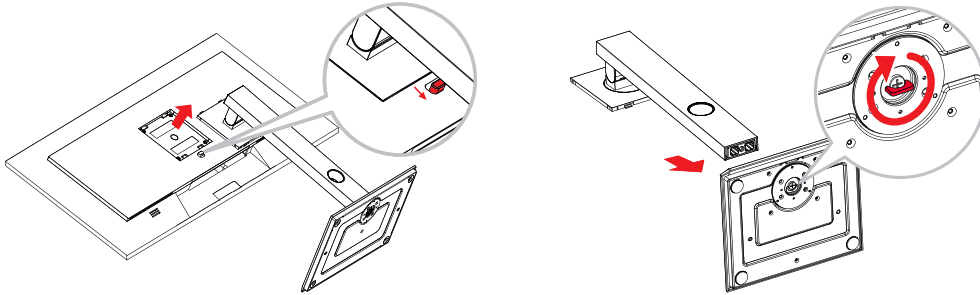

2. Wall mount the LCD monitor.

- First remove the 4 screws from the VESA holes. Then secure the 4 screw studs to the VESA holes.

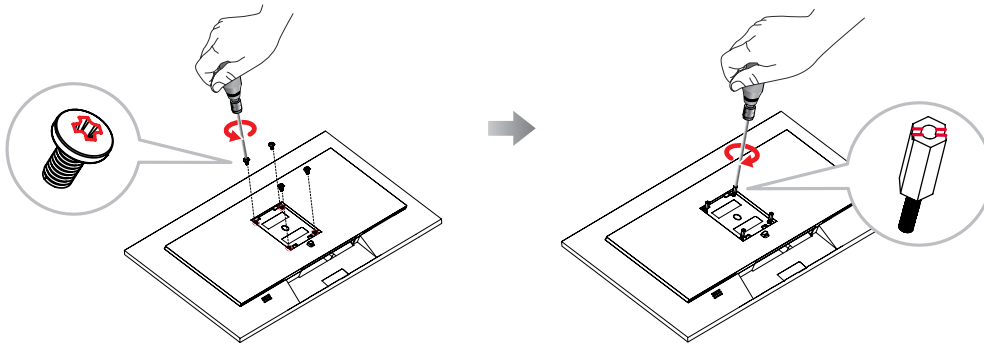

- Screw the mounting bracket to the VESA holes at the rear of the LCD display.

EM2401QC EM2701QC

EM3401UQC

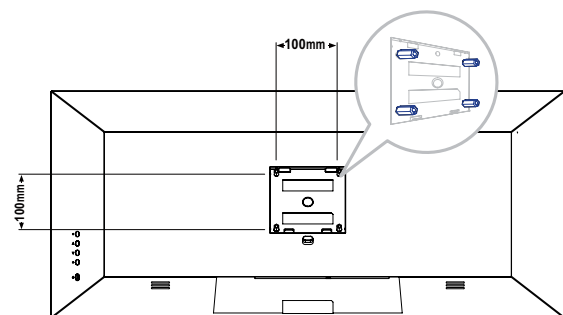
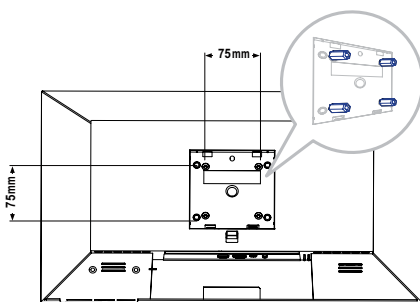

Note: Take measures to prevent the LCD monitor from falling down and lessen possible injury and damage to the monitor in case of earthquakes or other disasters.

- Use the 75 x 75 mm (EM2401QC EM2701QC) or 100 x 100 mm (EM3401UQC) wall mount kit recommended by AG Neovo. All AG Neovo wall mount kits comply with VESA standard.
- Secure the LCD monitor on a solid wall strong enough to bear its weight.
- It is suggested to wall mount the LCD monitor without tilting it facing downward.

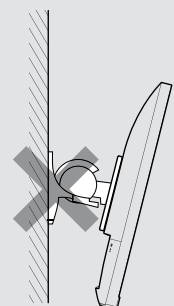

PRODUCT DESCRIPTION

1.3 Overview

1.3.1 Front View

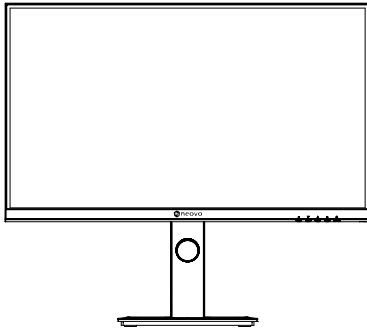

EM2401QC EM2701QC

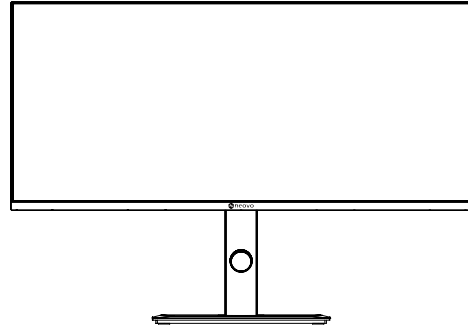

EM3401UQC

1.3.2 Control Panel

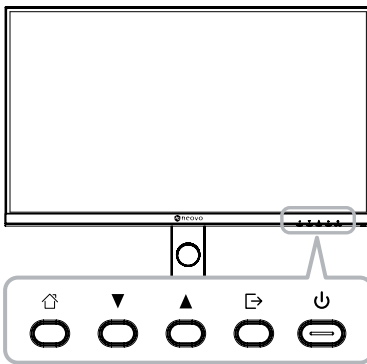

EM2401QC EM2701QC

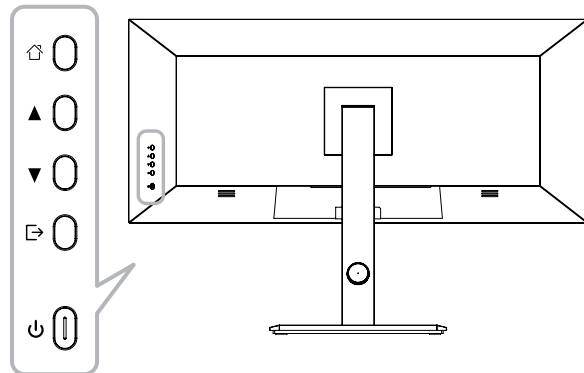

EM3401UQC

Button	Description
⌂ Button	Pops up the menu/Backs to the previous menu (in case of main menu, exits from the whole menu).
▲ Button	<ul style="list-style-type: none"> When the menu is activated, press this key to select the function. Press to move up in the menu/quickly adjust the volume.
▼ Button	<ul style="list-style-type: none"> When the menu opens, the value is incremented as the right function selection key. Press to move up in the menu. When the menu is closed, go to situational mode switch.
⇒ Button	<ul style="list-style-type: none"> Press to move up in the menu.
(⏻)	Power button: Powers on/off the monitor.
EM2401QC EM2701QC LED indicator light	Long bright (White LED): Normal boot state Flicker (Red LED): indicates No video source, no horizontal or vertical signal detected, or low voltage. LED off: Off mode
EM3401UQC LED indicator light	Long bright (Blue LED): Normal boot state Flicker (Red LED): indicates No video source, no horizontal or vertical signal detected, or low voltage. LED off: Off mode

PRODUCT DESCRIPTION

1.3.3 Rear View

EM2401QC EM2701QC

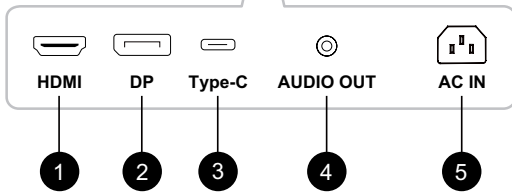
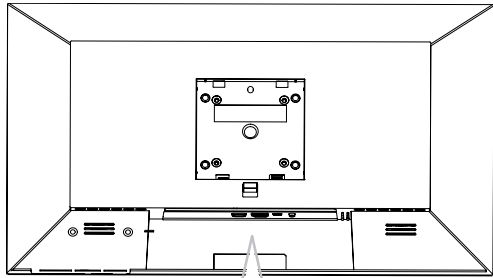

EM3401UQC

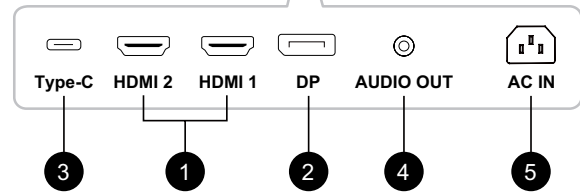
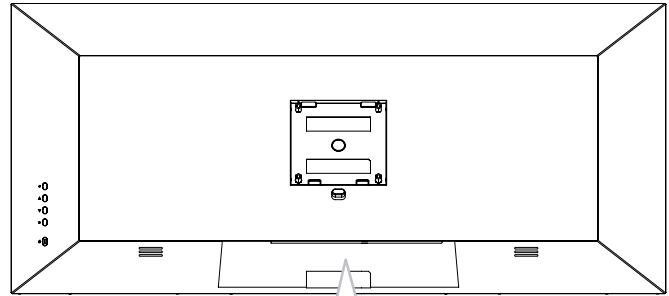

- 1 **HDMI**
Connect HDMI signals input.
- 2 **DP IN:**
Connect DisplayPort signals input.
- 3 **Type-C IN:**
Connect Type-C signals input.
- 4 **AUDIO OUT:**
Connect audio signals output (3.5 mm Stereo Audio Jack).
- 5 **AC IN:**
Connect the included power cord.

CHAPTER 2: MAKING CONNECTIONS

2.1 Making Connections

EM2401QC EM2701QC

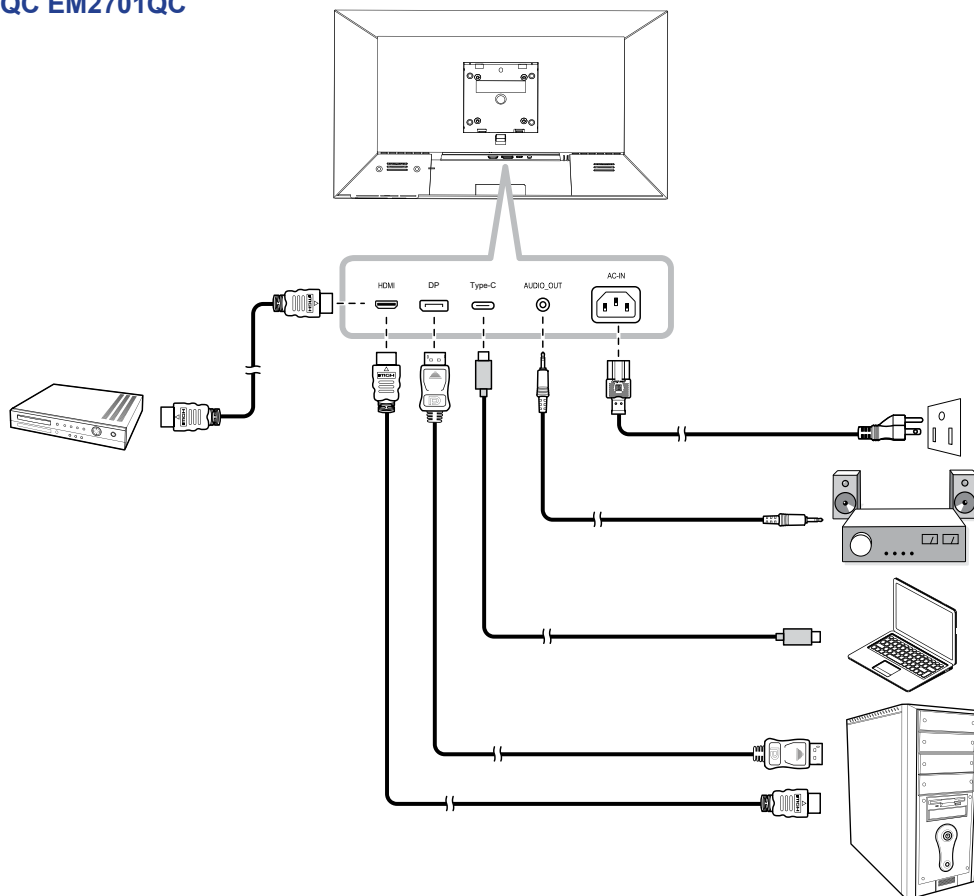

EM3401UQC

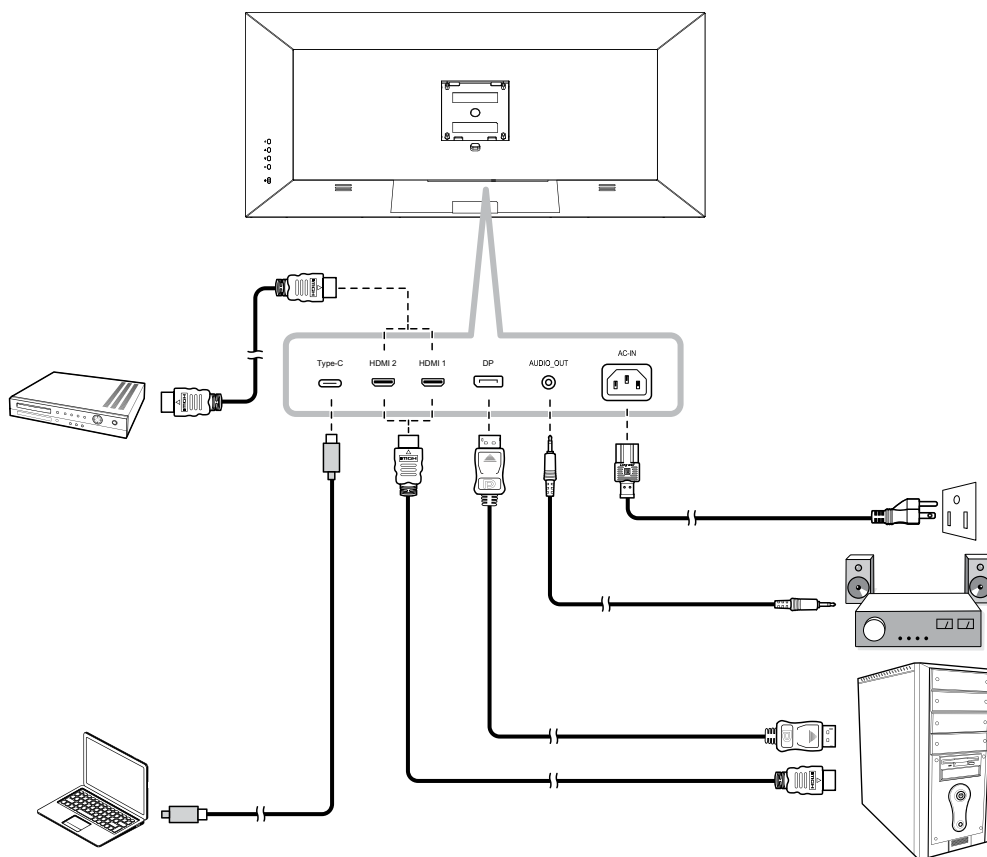

MAKING CONNECTIONS

- When charging connected device via USB Type-C Connector, check if the device is equipped with a USB Type-C Connector that supports charging function via USB PD (Power Delivery).
- The connected device can be charged via USB Type-C connector even when the monitor is in standby mode.
- The USB power delivery is up to 65W. If the connected device required more than 65W for operation or for boot up (when the battery is drained), use the original power adapter that came with the device.
- If a separately purchased USB Type-C Cable is used, make sure the cable is certified by USB-IF and is full-feature with power delivery and video/audio/data transfer functions.
- Compatibility with all connected devices is not guaranteed due to different user environments.

CHAPTER 3: ON SCREEN DISPLAY MENU

3.1 OSD Menu Tree

EM2401QC/EM2701QC

Main Menu	Submenu	Third menu	Description
Picture Settings	Brightness	0-100	Adjust the luminance of the screen image.
	Contrast	0-100	Adjust the difference between the black level and the white level.
	DCR	Off/On	Enable/Disable the DCR function. When enabled, it provides automatic adjustment of picture brightness and contrast at high speed and dynamic contrast range, such as when watching movies.
	Picture Mode	Standard Mode/Movie Mode/Reading Mode/Night Mode/Care Eyes Mode/SRGB Mode/Adobe Mode	Select a predefined picture setting.
	Anti Blue Light	0-100	Configure the blue light filter function. When enabled, it decreases the amount of blue light displayed on the screen, ensuring users a comfortable viewing experience by reducing eyestrain after long periods of use.
	Sharpness	0-5	Adjust the clarity and focus of the screen image.
	Gamma	Mode1/Mode2/Mode3/Mode4/Mode5/Mode6	Adjust the non-linear setting for picture luminance and contrast.
	Aspect Ratio	Wide Screen/4:3/1:1/Auto	Adjust the aspect ratio of the screen image.
Game Settings	Standard Mode	Off/On	Select On to use the default color settings.
	RTS/RPG Mode	Off/On	Select On to set the preset color settings for RTS(Real-Time Strategy)/RPG(Role-Playing Game)games.
	FPS Arena Mode	Off/On	Select On to set the preset color settings for FPS(First-Person Shooter) games.
	MOBA Arena Mode	Off/On	Select On to set the preset color settings for MOBA(Multiplayer Online Battle Arena) games.
	Adaptive-Sync	Off/On	Select On to let the system to synchronize the frame rate.
	Shadow Balance	0-100	Adjust the shadow balance setting that highlights the object details in dark color.
	Response Time	Off/Normal/Fast/Ultrafast	Select the response time setting for motion picture movement enhancement.
	Dynamic Brightness	Off/Normal/Expert/Elaboration	Select the dynamic brightness setting that highlights the object details in bright color.
Color Settings	Warm	Off/On	Enable/Disable the Warm color temperature.
	Natural	Off/On	Enable/Disable the Natural color temperature.
	Cool	Off/On	Enable/Disable the Cool color temperature.
	User1	Off/On: Red, Green, Blue	Select On to customize the red/green/blue output for User1.
	User2	Off/On: Red, Green, Blue	Select On to customize the red/green/blue output for User2.
	User3	Off/On: Red, Green, Blue	Select On to customize the red/green/blue output for User3.

ON SCREEN DISPLAY MENU

Main Menu	Submenu	Third menu	Description
Color Settings	Hue	Red/Green/Blue/Cyan/Magenta/ Yellow	Adjust the hue settings for the red, green, blue, cyan, magenta, or yellow color.
	Saturation	0-100	Adjust the colour saturation of the screen image.
PIP/PBP	PIP/PBP Mode	Off/PIP Mode/PBP 2win 1:1/PBP 2Win 2:1/PBP 2Win 1:2	Select PIP/PBP mode type or disable the function.
	Sub Win2 Input	DP/HDMI/Type-C	Set the input source for the sub window.
	Audio source	Auto/DP/HDMI/Type-C	Set the audio source for the main window.
	PIP Position	Top Right/Top Left/Bottom Right/ Bottom Left	Set the sub window position.
	PIP Size	Small/Medium/Large	Set the sub window size.
	Window Swap	Off/On	Select On to swap the two windows (main source and sub source signals).
OSD Settings	Language	English/简体中文/한국어/ العربية/Portugues do Brasilazil/ Deutsch/Nederland/Suomi/ Français/Ελληνικά/Indonesia/ Italiano/日本語/Malaysia/Polskie/ Português/Русский/Español/ Українська/Tiếng Việt/繁體 中文/Türkçe	Select the OSD language.
	OSD Time Out	0-100	Set the length of time (in seconds) the OSD screen is displayed. When the time elapses, the OSD screen is automatically inactivated.
	OSD H-Position	0-100	Move the OSD window to the left or right of the screen.
	OSD V-Position	0-100	Move the OSD window up or down the screen.
	OSD transparency	0-5	Set the transparency of the OSD menu.
	Hotkey1 Setting	Brightness/Contrast/Volume/ Mute/Shadow Balance/Adaptive- Sync/Picture Mode/PIP/PBP/ Input Signal/Dynamic Brightness	Assign the function of the hot keys.
	Hotkey2 Setting		
	Hotkey3 Setting		
	OSD Rotation	Normal/90/180/270	Set the OSD menu orientation.
OSD Lock	Off/On	Select On to disable the OSD adjustments. Note: When user locks the menu, keep pressing the  button for at least 10 seconds to unlock.	

ON SCREEN DISPLAY MENU

Main Menu	Submenu	Third menu	Description
Other Settings	Input Signal	Auto/DP/HDMI/Type-C	Set the default input signal.
	Volume	0-100	Adjust the volume level of the built-in speaker.
	Mute	Off/On	Turn the audio speaker on or off.
	Auto Power	Off/On	Select On: If the monitor cannot detect any input source signal, and the monitor will automatically turn off after 1 minute. At this time, even if an input source is connected, the screen will be unable to be awakened. Select Off: If the monitor cannot detect any input source signal, and the display will automatically enter standby mode after 1 minute. At this time, if an input source is connected, the screen can be awakened.
	Rest Remind	Off/On	Select On to let a reminder message to appear after using the device for 4 hours.
	Reset	No/Yes	Reset all settings to the factory defaults.
	Information	Input Source: / Resolution:/ Mode:	View the information about the device.



EM3401UQC

Main Menu	Submenu	Third menu	Description
Picture Settings	Brightness	0-100	Adjust the luminance of the screen image.
	Contrast	0-100	Adjust the difference between the black level and the white level.
	DCR	Off/On	Enable/Disable the DCR function. When enabled, it provides automatic adjustment of picture brightness and contrast at high speed and dynamic contrast range, such as when watching movies. DCR is suitable for indoor viewing.
	Picture Mode	Standard Mode/Movie Mode/ Reading Mode/Night Mode/Care Eyes Mode/SRGB Mode/Adobe Mode	Select a predefined picture setting.
	Anti Blue Light	0-100	Configure the blue light filter function. When enabled, it decreases the amount of blue light displayed on the screen, ensuring users a comfortable viewing experience by reducing eyestrain after long periods of use.
	Sharpness	0-5	Adjust the clarity and focus of the screen image.
	Gamma	Mode1/Mode2/Mode3/Mode4/ Mode5/Mode6	Adjust the non-linear setting for picture luminance and contrast.
	Aspect Ratio	Wide Screen/4:3/1:1/Auto	Adjust the aspect ratio of the screen image.

ON SCREEN DISPLAY MENU

Main Menu	Submenu	Third menu	Description
Game Settings	Standard Mode	Off/On	Select On to use the default color settings.
	RTS/RPG Mode	Off/On	Select On to set the preset color settings for RTS(Real-Time Strategy)/RPG(Role-Playing Game)games games.
	FPS Arena Mode	Off/On	Select On to set the preset color settings for FPS(First-Person Shooter) games.
	MOBA Arena Mode	Off/On	Select On to set the preset color settings for MOBA(Multiplayer Online Battle Arena) games.
	Adaptive-Sync	Off/On	Select On to let the system to synchronize the frame rate.
	Shadow Balance	0-100	Adjust the shadow balance setting that highlights the object details in dark color.
	Response Time	Off/Normal/Fast/Ultrafast	Select the response time setting for motion picture movement enhancement.
	Dynamic Brightness	Off/Normal/Expert/Elaboration	Select the dynamic brightness setting that highlights the object details in bright color.
	HDR	O/HDR Standard/HDR Movie/HDR RTS/RPG/HDR FPS	Select the HDR mode.
Color Settings	Warm	Off/On	Enable/Disable the Warm color temperature.
	Natural	Off/On	Enable/Disable the Natural color temperature.
	Cool	Off/On	Enable/Disable the Cool color temperature.
	User1	Off/On: Red, Green, Blue	Select On to customize the red/green/blue output for User1.
	User2	Off/On: Red, Green, Blue	Select On to customize the red/green/blue output for User2.
	User3	Off/On: Red, Green, Blue	Select On to customize the red/green/blue output for User3.
Color Settings	Hue	Red/Green/Blue/Cyan/Magenta/Yellow	Adjust the hue settings for the red, green, blue, cyan, magenta, or yellow color.
	Saturation	0-100	Adjust the colour saturation of the screen image.
PIP/PBP	PIP/PBP Mode	Off/PIP Mode/PBP 2win 1:1/PBP 2Win 2:1/PBP 2Win 1:2	Select PIP/PBP mode type or disable the function.
	Sub Win2 Input	DP/HDMI1/HDMI2/Type-C	Set the input source for the sub window.
	Audio source	Auto/DP/HDMI1/HDMI2/Type-C	Set the audio source for the main window.
	PIP Position	Top Right/Top Left/Bottom Right/Bottom Left	Set the sub window position.
	PIP Size	Small/Medium/Large	Set the sub window size.
	Window Swap	Off/On	Select On to swap the two windows (main source and sub source signals).

ON SCREEN DISPLAY MENU

Main Menu	Submenu	Third menu	Description
OSD Settings	Language	English/简体中文/한국어/ العربية/Portugues do Brasilazil/ Deutsch/Nederland/Suomi/ Français/Ελληνικά/Indonesia/ Italiano/日本語/Malaysia/Poliskie/ Português/Русский/Español/ Українська/Việt/繁體 中文/Türkçe	Select the OSD language.
	OSD Time Out	0-100	Set the length of time (in seconds) the OSD screen is displayed. When the time elapses, the OSD screen is automatically inactivated.
	OSD H-Position	0-100	Move the OSD window to the left or right of the screen.
	OSD V-Position	0-100	Move the OSD window up or down the screen.
	OSD transparency	0-5	Set the transparency of the OSD menu.
	Hotkey1 Setting	Brightness/Contrast/Volume/ Mute/Shadow Balance/ Adaptive-Sync/Picture Mode/ PIP/PBP/Input Signal/Dynamic Brightness/HDR	Assign the function of the hot keys.
	Hotkey2 Setting		
	Hotkey3 Setting		
	OSD Rotation	Normal/90/180/270	Set the OSD menu orientation.
	OSD Lock	Off/On	Select On to disable the OSD adjustments. Note: When user locks the menu, keep pressing the  button for at least 10 seconds to unlock..
Other Settings	Input Signal	DP/HDMI1/HDMI2/Type-C	Set the default input signal.
	Volume	0-100	Adjust the volume level of the built-in speaker.
	Mute	Off/On	Turn the audio speaker on or off.
	Auto Power	Off/On	Select On: If the monitor cannot detect any input source signal, and the monitor will automatically turn off after 1 minute. At this time, even if an input source is connected, the screen will unable to be awakened. Select Off: If the monitor cannot detect any input source signal, and the display will automatically enter standby mode after 1 minute. At this time, if an input source is connected, the screen can be awakened.
	Rest Remind	Off/On	Select On to let a reminder message to appear after using the device for 4 hours. Note: The pop-up notice will disappear when pressing the  button or after 3 seconds.
	Reset	No/Yes	Reset all settings to the factory defaults.
	Information	Input Source: / Resolution:/ Mode: / HDR Ver:	View the information about the device.

CHAPTER 4: APPENDIX

4.1 Warning Messages

When any of these warning messages appear, check the following items.

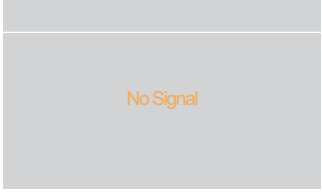
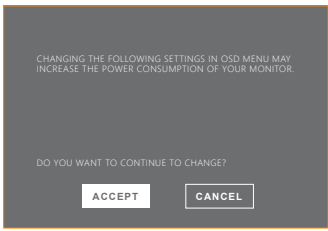
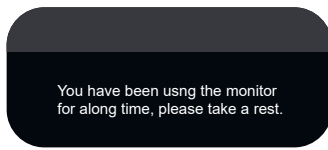
Warning Message	Cause	Solution
 <p>The image shows a grey rectangular warning message box with the text "No Signal" in orange font centered on the screen.</p>	<p>The LCD monitor cannot detect the input source signal.</p>	<ul style="list-style-type: none"> ✓ Check if the input source is turned ON. ✓ Check if the signal cable is properly connected. ✓ Check if any pin inside the cable connector is twisted or broken.
 <p>The image shows a dark grey warning message box with white text. The text reads: "CHANGING THE FOLLOWING SETTINGS IN OSD MENU MAY INCREASE THE POWER CONSUMPTION OF YOUR MONITOR. DO YOU WANT TO CONTINUE TO CHANGE?" Below the text are two buttons labeled "ACCEPT" and "CANCEL".</p>	<p>This warning message box will only show when the menu feature setting is changed for the first time.</p>	<ul style="list-style-type: none"> ✓ Press the ACCEPT button to continue the setting changes, or press the CANCEL button to disable the setting changes. <div style="border: 1px solid black; padding: 5px; margin-top: 10px;"> <p>Note: <i>The operation may vary from different product models.</i></p> </div>
 <p>The image shows a dark blue rounded rectangular reminder message box with white text that reads: "You have been using the monitor for along time, please take a rest."</p>	<p>This reminder message will appear after using the device for 4 hours.</p>	<ul style="list-style-type: none"> ✓ The pop-up notice will disappear when pressing the ⏏ button or after 3 seconds.

APPENDIX

4.2 Troubleshooting

Problems	Possible Cause and Solution
The power indicator light is not on	<ul style="list-style-type: none">• Check if the power is on.• Check if the power cord is connected.
Impossible plug-and-play	<ul style="list-style-type: none">• Check if the function of plug-and-play of the device is compatible with PC.• Check if the graphic card is compatible with the plug-and-play function.• Check the signal cable plug of the monitor and make sure every pin has no bending.
Flickering picture or picture with ripples	<ul style="list-style-type: none">• There may be electrical appliances or equipment with electronic disturbance.
The power indicator light is on (flickering), but the monitor has no picture.	<ul style="list-style-type: none">• Check if the PC power is on.• Check if the PC graphic card is inserted properly.• Check if the signal cable of the monitor is correctly connected with the PC.• Check the signal cable plug of the monitor and make sure every pin has no bending.• Observe the indicator light by pressing the Caps Lock key on the PC keyboard and check if the PC is working.
Picture with color difference (white looks not white)	<ul style="list-style-type: none">• Adjust RGB color or reselect color temperature.
USB Type-C port does not supply power	<ul style="list-style-type: none">• Check that the connected device is compliant with the USB-C specification. The USB Type-C port supports an output of 65W.
PIP mode does not work.	<ul style="list-style-type: none">• The main and sub input source signals are not compatible to be displayed together in PIP mode.

CHAPTER 5: SPECIFICATIONS

5.1 Display Specifications

		EM2401QC	EM2701QC	EM3401UQC
Panel	Panel	LED-Backlit TFT LCD (IPS Technology)	LED-Backlit TFT LCD (IPS Technology)	LED-Backlit TFT LCD (IPS Technology)
	Panel Size	23.8"	27"	34"
	Colour Gamut	sRGB 133% , NTSC 115% , DCI-P3 105% , Adobe RGB 115%	sRGB 140% , NTSC 124% , DCI-P3 113% , Adobe RGB 123%	sRGB 130% , NTSC 110% , DCI-P3 100% , Adobe RGB 110%
	Max. Resolution	WQHD 2560 x 1440	WQHD 2560 x 1440	UWQHD 3440 x 1440
	Pixel Pitch	0.206 mm	0.233 mm	0.233 mm
	Brightness	300 cd/m ²	350 cd/m ²	350 cd/m ²
	Contrast Ratio	1000000:1(DCR)	1000000:1(DCR)	1000000:1(DCR)
	Viewing Angle (H/V)	178°/178°	178°/178°	178°/178°
	Display Colour	16.7M	16.7M	16.7M
	Response Time	5 ms	5 ms	5 ms
	Surface Treatment	Anti-Glare Treatment (Haze 25%), 3H Hard Coating	Anti-Glare Treatment (Haze25%),3H Hard Coating	Anti-Glare Treatment (Haze25%),3H Hard Coating
Frequency (H/V)	H Freq.	30 kHz-112 kHz	30 kHz-112 kHz	30 kHz-112 kHz
	V Freq.	50 Hz-76 Hz	50 Hz-76 Hz	50 Hz-76 Hz
Input	DisplayPort	1.2 x 1	1.2 x 1	1.2 x 1
	HDMI	2.0 x 1	2.0 x 1	2.0 x 1 ; 1.4 x 1
Other Connectivity	USB	Type-C x 1 (PD 65W)	Type-C x 1 (PD 65W)	Type-C x 1 (PD 65W)
Audio	Audio Out	Stereo Audio Jack (3.5 mm)	Stereo Audio Jack (3.5 mm)	Stereo Audio Jack (3.5 mm)
	Internal Speakers	2W x 2	2W x 2	2W x 2
Power	Power Supply	Internal	Internal	Internal
	Power Requirements	AC 100-240V, 50/60 Hz 2.0A	AC 100-240V, 50/60 Hz 2.0A	AC 100-240V, 50/60 Hz 2.5A
	On Mode	17W (On)	24W (On)	31W (ON)
	Standby Mode	< 0.5W	< 0.5W	< 0.5W
	Off Mode	< 0.3W	< 0.3W	< 0.3W
Operating Conditions	Temperature	0°C-40°C(32°F-104°F)	0°C-40°C (32°F-104°F)	0°C-40°C (32°F-104°F)
	Humidity	10%-90% (non-condensing)	10%-90% (non-condensing)	10%-90% (non-condensing)
Storage Conditions	Temperature	-20°C-60°C (-4°F-140°F)	-20°C-60°C (-4°F-140°F)	-20°C-60°C(-4°F-140°F)
	Humidity	5%-95% (non-condensing)	5%-95% (non-condensing)	5%-95% (non-condensing)
Mounting	VESA FPMPMI	Yes (75 x 75 mm)	Yes (75 x 75 mm)	Yes (100 x 100 mm)
Stand	Tilt	-5° to 20°	-5° to 20°	-5° to 15°
	Pivot	0° to 90°	0° to 90°	N/A
	Swivel	± 45°	± 45°	± 30°
	Height Adjustment	0-120 mm	0-120 mm	0-120 mm
Dimensions	Product with Base (W x H x D)	539.6 x 513.8 x 197.9 mm (21.2" x 20.2" x 7.8")	613.3 x 543.4 x 197.9 mm (24.2" x 21.4" x 7.8")	817.0 x 560.6 x 218.8 mm (32.2" x 22.1" x 8.6")
	Product w/o Base (W x H x D)	539.6 x 324.5 x 53.3 mm (21.2" x 12.8" x 2.1")	613.3 x 367.3 x 57.2 mm (24.2" x 14.5" x 2.3")	817.0 x 362.5 x 59.8 mm (32.2" x 14.3" x 2.4")
	Packaging (W x H x D)	810.0 x 438.0 x 145.0 mm (31.9" x 17.2" x 5.7")	920.0 x 457.0 x 168.0 mm (36.2" x 18.0" x 6.6")	960.0 x 505.0 x 218.0 mm (37.8" x 19.9" x 8.6")
Weight	Product w/o Base	3.9 kg (8.6 lb)	4.0 kg (8.8 lb)	7.6 kg (16.8 lb)
	Product with Base	5.8 kg (12.8 lb)	6.0 kg (13.2 lb)	11.1 kg (24.5 lb)
	Packaging	8.5 kg (18.7 lb)	8.8 kg (19.4 lb)	14.5 kg (32.0 lb)

Note: All specifications are subject to change without prior notice.

CHAPTER 5: SPECIFICATIONS

5.2 Display Dimensions

EM2401QC

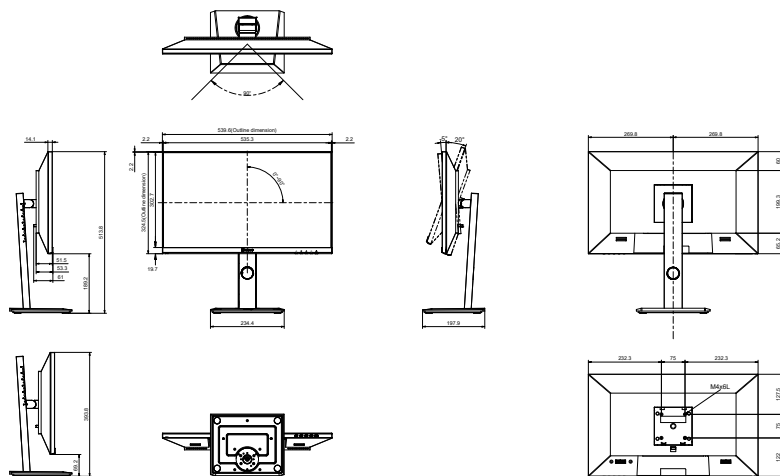

EM2701QC

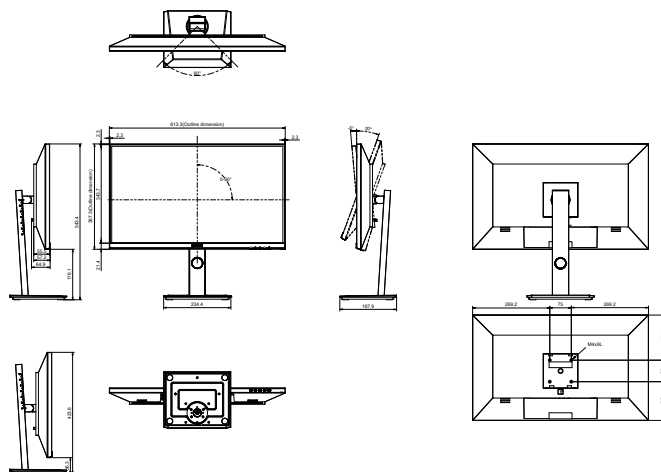

EM3401UQC

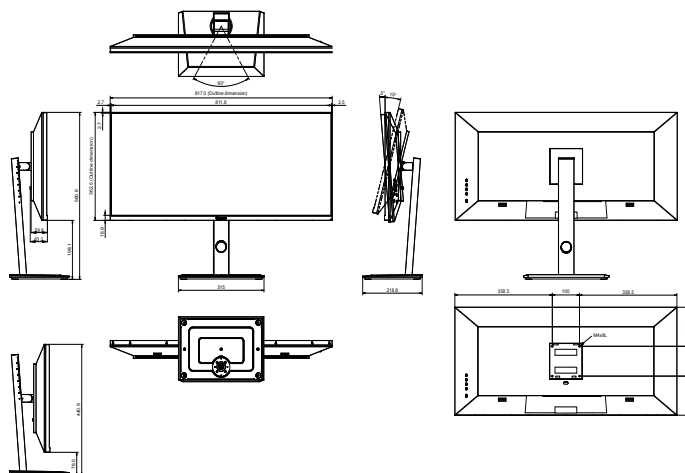

AG Neovo

Company Address: 5F-1, No. 3-1, Park Street, Nangang District, Taipei, 11503, Taiwan.

Copyright © 2022 AG Neovo. All rights reserved.

EM2410/EM2710/EM3410_UM_V010