



**THE DISPLAY CHOICE  
OF PROFESSIONALS™**

**DR-17E & DR-22E LED-Backlit Display**

# **User Manual**

[www.agneovo.com](http://www.agneovo.com)

# TABLE OF CONTENTS

## Safety Information

Federal Communications Commission (FCC) Notice (U.S. Only).....	4
WEEE.....	5
EMC Information .....	6

## Precautions

Notice .....	10
Cautions When Setting Up .....	11
Cautions When Using.....	12
Cleaning and Maintenance.....	12
Notice for the LCD Display .....	13

## Chapter 1: Product Description

1.1 Package Contents .....	15
1.2 Wall Mounting Installation Preparation .....	16
1.2.1 Wall Mounting.....	16
1.2.2 Removing the Base Stand.....	16
1.3 LCD Display Overview .....	17
1.3.1 Front View and Keypad Buttons.....	17
1.3.2 Rear View .....	18

## Chapter 2: Making Connections

2.1 Connecting the Power .....	20
2.2 Connecting Input Source Signals .....	21
2.2.1 Connecting a Computer .....	21
Using DVI Cables .....	21
Using VGA Cables .....	21
Using Audio Cables.....	22
Using RS-232 Cables.....	22
2.2.2 Connecting a Camera or Video Device .....	23
Using S-Video Cables .....	23
Using CVBS Cables .....	23
Using HDMI Cables.....	24
Using DisplayPort Cables .....	24
2.3 Connecting a Stereo Amplifier.....	25
2.4 Connecting a USB Storage Device (For Firmware Update).....	25

## Chapter 3: Using the LCD Display

3.1 Turning on the Power .....	26
3.2 Selecting the Input Source Signal .....	26
3.3 Adjusting the Volume / Illuminator Function Hot Key.....	27
3.3.1 Muting the Audio.....	27
3.4 Locking the OSD Menu .....	27
3.5 Using FREEZE Function .....	28
3.6 Using Auto Adjustment Function .....	28

# TABLE OF CONTENTS

## Chapter 4: On Screen Display Menu

4.1 Using the OSD Menu .....	29
4.2 OSD Menu Tree .....	31

## Chapter 5: Adjusting the LCD Display

5.1 BRIGHTNESS .....	34
5.2 COLOUR TEMP.....	36
5.3 IMAGE SETTING .....	37
5.4 ASPECT RATIO.....	40
5.5 ANTI-BURN-IN .....	41
5.6 OSD SETTING .....	42
5.7 AUDIO SETTING.....	43
5.8 SYSTEM.....	44
5.9 ECO SMART .....	46
5.10 INPUT SELECT.....	47

## Chapter 6: Appendix

6.1 Warning Messages.....	48
6.2 Troubleshooting.....	49
6.3 Transporting the LCD Display .....	50

## Chapter 7: Specifications

7.1 Display Specifications .....	51
7.2 Display Dimensions.....	52
7.2.1 DR-17E Dimensions.....	52
7.2.2 DR-22E Dimensions.....	52

# SAFETY INFORMATION

## Federal Communications Commission (FCC) Notice (U.S. Only)



This equipment has been tested and found to comply with the limits for a Class B digital device, pursuant to part 15 of the FCC Rules. These limits are designed to provide reasonable protection against harmful interference in a residential installation. This equipment generates, uses and can radiate radio frequency energy and, if not installed and used in accordance with the instructions, may cause harmful interference to radio communications. However, there is no guarantee that interference will not occur in a particular installation. If this equipment does cause harmful interference to radio or television reception, which can be determined by turning the equipment off and on, the user is encouraged to try to correct the interference by one or more of the following measures:

- Reorient or relocate the receiving antenna.
- Increase the separation between the equipment and receiver.
- Connect the equipment into an outlet on a circuit different from that to which the receiver is connected.
- Consult the dealer or an experienced radio/TV technician for help.



Changes or modifications not expressly approved by the party responsible for compliance could void the user's authority to operate the equipment.

Use only an RF shielded cable that was supplied with the display when connecting this display to a computer device.

To prevent damage which may result in fire or shock hazard, do not expose this appliance to rain or excessive moisture.

THIS CLASS B DIGITAL APPARATUS MEETS ALL REQUIREMENTS OF THE CANADIAN INTERFERENCE-CAUSING EQUIPMENT REGULATIONS.



This device complies with Part 15 of the FCC Rules. Operation is subject to the following two conditions: (1) this device may not cause harmful interference, and (2) this device must accept any interference received, including interference that may cause undesired operation.

# SAFETY INFORMATION

## WEEE

Information for users applicable in European Union countries.

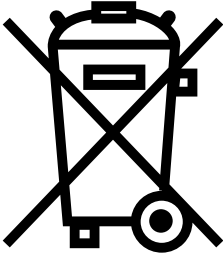

The symbol on the product or its packaging signifies that this product has to be disposed separately from ordinary household wastes at its end of life. Please kindly be aware that this is your responsibility to dispose electronic equipment at recycling centers so as to help conserve natural resources. Each country in the European Union should have its collection centers for electrical and electronic equipment recycling. For information about your recycling drop off area, please contact your local related electrical and electronic equipment waste management authority or the retailer where you bought the product.

Standard	Test item	Standard
EN60601-1-2:2007	RAD & CON	EN55011(EMI)
	Harmonic	EN61000-3-2
	Flicker	EN61000-3-3
	ESD	IEC 61000-4-2
	RS	IEC 61000-4-3
	EFT	IEC 61000-4-4
	Surge	IEC 61000-4-5
	CS	IEC 61000-4-6
	PFM	IEC 61000-4-8
	DIP	IEC 61000-4-11

# SAFETY INFORMATION

## EMC Information

### CAUTION

The DR-17E and DR-22E requires special precautions regarding EMC and need to be installed, put into service and used according to the following information.

Do not use any cables other than the cables that provided or specified by us. Using other cables may cause the increase of emission or decrease of immunity.

Do not put any portable and mobile RF communications equipment close to the DR-17E and DR-22E. Doing so may affect the DR-17E and DR-22E.

The DR-17E and DR-22E should not be used adjacent to or stacked with other equipment. If adjacent or stacked use is necessary, the equipment or system should be observed to verify normal operation in the configuration in which it will be used.

Anyone who connects additional equipment to the signal input part or signal output parts, configuring a medical system, responsible that the system complies with the requirements of IEC/ EN60601-1-2.

Guidance and manufacturer's declaration – electromagnetic emissions		
The DR-17E and DR-22E is intended for use in the electromagnetic environment specified below. The customer or the user of the DR-17E and DR-22E should assure that it is used in such an environment. Not Life-supporting Medical Equipment.		
Emissions test		Electromagnetic environment – guidance
RF emissions CISPR11/EN55011	Compliance Group 1	The DR-17E and DR-22E uses RF energy only for its internal function. Therefore, its RF emission are very low and are not likely to cause any interference in nearby electronic equipment.
RF emissions CISPR11/EN55011	Class B	The DR-17E and DR-22E is suitable for use in all establishments, including domestic establishments and those directly connected to the public low-voltage power supply network that supplies buildings used for domestic purposes.
Harmonic emissions IEC/EN61000-3-2	Class A	
Voltage fluctuations / flicker emissions IEC/ EN61000-3-3	Class A	

# SAFETY INFORMATION

## Guidance and manufacturer's declaration – electromagnetic immunity

The DR-17E and DR-22E is intended for use in the electromagnetic environment specified below. The customer or the user of The DR-17E and DR-22E should assure that it is used in such an environment. Not Life-supporting Medical Equipment.

IMMUNITY test	IEC/EN60601 test level	Compliance level	Electromagnetic environment – guidance
Electrostatic discharge (ESD) IEC/EN61000-4-2	±8 kV contact ±15 kV air	±8 kV contact ±15 kV air	Floors should be wood, concrete or ceramic tile. If floors are covered with synthetic material, the relative humidity should be at least 30%.
Electrical fast transient / burst IEC/EN61000-4-4	±2 kV for power supply lines ±1 kV for input/output lines	±2 kV for power supply lines ±1 kV for input/output lines	Mains power quality should be that of a typical commercial or hospital environment.
Surge IEC/EN61000-4-5	For power supply lines: ± 1 kV line(s) to line(s) ± 2 kV line(s) to earth For outdoor signal lines: ± 2 kV line(s) to earth	For power supply lines: ± 1 kV line(s) to line(s) ± 2 kV line(s) to earth For outdoor signal lines: ± 2 kV line(s) to earth	Mains power quality should be that of a typical commercial or hospital environment.
Voltage dips, short interruptions and voltage variations on power supply input lines IEC 61000-4-11	0% UT; 0,5 cycle 0% UT; 1 cycle 70% UT; 25/30 cycles <5% UT; 250/300 cycles	0% UT; 0,5 cycle 0% UT; 1 cycle 70% UT; 25/30 cycles <5% UT; 250/300 cycles	Mains power quality should be that of a typical commercial or hospital environment. If the user of the DR-17E and DR-22E requires continued operation during power mains interruptions, it is recommended that the DR-17E and DR-22E be powered from an uninterruptible power supply or a battery.
Power frequency (50/60Hz) magnetic field IEC/EN61000-4-8	3A/m	3A/m	Power frequency magnetic fields should be at levels characteristic of a typical location in a typical commercial or hospital environment.

**NOTE:** UT is the a.c. mains voltage prior to application of the test level.

Mains power quality should be that of a typical commercial or hospital environment. If the user of the DR-17E and DR-22E requires continued operation during power mains interruptions, it is recommended that the DR-17E and DR-22E be powered from an uninterruptible power supply or a battery.

# SAFETY INFORMATION

## Guidance and manufacturer's declaration – electromagnetic immunity

The DR-17E and DR-22E is intended for use in the electromagnetic environment specified below. The customer or the user of the DR-17E and DR-22E should assure that it is used in such an environment.  
Not Life-supporting Medical Equipment.

Immunity test	IEC/EN60601 test level	Compliance level	Electromagnetic environment – guidance
Conducted RF IEC/ EN61000-4-6 Radiated RF IEC/ EN61000-4-3	3Vrms 150kHz to 80MHz 3V/m 80MHz to 2.5GHz	3Vrms 3V/m	Portable and mobile RF communications equipment should be used no closer to any part of the DR-17E and DR-22E, including cables, than the recommended separation distance calculated from the equation applicable to the frequency of the transmitter. Recommended Separation distance $d = 1.2 \sqrt{P}$ $d = 1.2 \sqrt{P}$ , 80MHz to 800MHz $d = 2.3 \sqrt{P}$ , 800MHz to 2.5GHz Where “P” is the maximum output power rating of the transmitter in watts (W) according to the transmitter manufacturer and “d” is the recommended separation distance in meters (m). Field strengths from fixed RF transmitters, as determined by an electromagnetic site survey, should be less than the compliance level in each frequency range. Interference may occur in the vicinity of equipment marked with the following symbol. 

**NOTE 1** At 80 MHz and 800 MHz, the higher frequency range applies.

**NOTE 2** These guidelines may not apply in all situations. Electromagnetic propagation is affected by absorption and reflection from structures, objects and people.

a Field strengths from fixed transmitters, such as base stations for radio (cellular/cordless) telephones and land mobile radios, amateur radio, AM and FM radio broadcast and TV broadcast cannot be predicted theoretically with accuracy. To assess the electromagnetic environment due to fixed RF transmitters, an electromagnetic site survey should be considered. If the measured field strength in the location in which the DR-17E and DR-22E is used exceeds the applicable RF compliance level above, the DR-17E and DR-22E should be observed to verify normal operation. If abnormal performance is observed, additional measures may be necessary, such as reorienting or relocating the DR-17E and DR-22E.



# SAFETY INFORMATION

## ESD declaration statement

There are flicker disturbance on the screen during the test, but auto recover after the test. This permissive loss of performance is specified by the manufacturer, and this phenomena will be put as a clear statement in the User's Manual to avoid misunderstanding.

## DIP declaration statement

The EUT power off during the test, but self- recover after the test. This permissive loss of performance is specified by the manufacturer, and this phenomena will be put as a clear statement in the User's Manual to avoid misunderstanding.

## Recommended separation distances between portable and mobile RF communications equipment and the DR-17E and DR-22E

The DR-17E and DR-22E is intended for use in an electromagnetic environment in which radiated RF disturbances are controlled. The customer or the user of the DR-17E and DR-22E can help prevent electromagnetic interference by maintaining a minimum distance between portable and mobile RF communications equipment (transmitters) and the DR-17E and DR-22E as recommended below, according to the maximum output power of the communications equipment.

Rated maximum output power of transmitter (W)	Separation distance according to frequency of transmitter (m)		
	150kHz to 80MHz $d = 1.2 \sqrt{P}$	80MHz to 800MHz $d = 1.2 \sqrt{P}$	800MHz to 2.5GHz $d = 2.3 \sqrt{P}$
0.01	0.12	0.12	0.23
0.1	0.38	0.38	0.73
1	1.2	1.2	2.3
10	3.8	3.8	7.3
100	12	12	23

For transmitters rated at a maximum output power not listed above, the recommended separation distance "d" in meters (m) can be estimated using the equation applicable to the frequency of the transmitter, where "P" is the maximum output power rating of the transmitter in watts (W) according to the transmitter manufacturer.

**NOTE 1** At 80 MHz and 800 MHz, the separation distance for the higher frequency range applies.

**NOTE 2** These guidelines may not apply in all situations. Electromagnetic propagation is affected by absorption and reflection from structures, objects and people.

## Cable length

Power Cord : Accessory	1.8m
------------------------	------



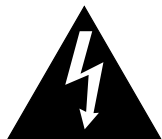





# PRECAUTIONS



**CAUTION**  
RISK OF ELECTRIC SHOCK  
DO NOT OPEN



## Symbols used in this manual

	This icon indicates the existence of a potential hazard that could result in personal injury or damage to the product.		ISO 7010-M002: Follow instructions for use
	This icon indicates important operating and servicing information.		This icon indicates complies with the 93/42/EEC, EN60601-1, EN 60601-1-2 of related European standards.
	IEC 60417 -5009 : STAND- BY		IEC 60417 -5031 : Direct Current
	IEC 60417 -5032: Alternating Current.		IEC 60417 -5021: Equipotentiality

## Notice

- Read this User Manual carefully before using the LCD display and keep it for future reference.
- The product specifications and other information provided in this User Manual are for reference only. All information is subject to change without notice. Updated content can be downloaded from our web site at <http://www.agneovo.com>.
- To register online, go to <http://www.agneovo.com>.
- To protect your rights as a consumer, do not remove any stickers from the LCD display. Doing so may affect the determination of the warranty period.

# PRECAUTIONS

## Cautions When Setting Up



Do not place the LCD display near heat sources, such as a heater, exhaust vent, or in direct sunlight.



Do not cover or block the ventilation holes in the housing.



Place the LCD display on a stable area. Do not place the LCD display where it may be subject to vibration or shock.



Place the LCD display in a well-ventilated area.



Do not place the LCD display outdoors.



Do not place the LCD display in a dusty or humid environment.



Do not spill liquid or insert sharp objects into the LCD display through the ventilation holes. Doing so may cause accidental fire, electric shock or damage the LCD display.

# PRECAUTIONS

## Cautions When Using



Use only the power cord supplied with the LCD display.



The power outlet should be installed near the LCD display and be easily accessible.



If an extension cord is used with the LCD display, ensure that the total current consumption plugged into the power outlet does not exceed the ampere rating.



Do not allow anything to rest on the power cord. Do not place the LCD display where the power cord may be stepped on.



If the LCD display will not be used for an indefinite period of time, unplug the power cord from the power outlet.



To disconnect the power cord, grasp and pull by the plug head. Do not tug on the cord; doing so may cause fire or electric shock.

The mains plug or appliance coupler is used as the disconnect device, the disconnect device shall remain readily operable. Always completely disconnect the power cord set from your product whenever you are working or cleaning on it. Do not make connections while the power is on, because a sudden rush of power can damage sensitive electronic components.



Do not unplug or touch the power cord with wet hands.

## Cleaning and Maintenance

Disconnect this equipment from any AC outlet before cleaning. Do not use liquid or spray detergents for cleaning. Use a damp cloth. Keeping to clean your monitor by monthly.



The LCD display comes with NeoV™ Optical Glass. Use a soft cloth to clean the glass surface and the housing. The display can be cleaned using a cloth moistened with 95% ethyl alcohol.



Do not rub or tap the surface of the glass with sharp or abrasive items such as a pen or screwdriver. This may result in scratching the surface of the glass.



Do not attempt to service the LCD display yourself, refer to qualified service personnel. Opening or removing the covers may expose you to dangerous voltage or other risks.



### Warning:



Unplug the power cord from the power outlet and refer to qualified service personnel under the following conditions:

- ◆ When the power cord is damaged.
- ◆ If the LCD display has been dropped or the housing has been damaged.
- ◆ If the LCD display emits smoke or a distinct odor.



### Warning:



Ceiling mount or mount on any other horizontal surface overhead are not advisable.

Installation in contravention of the instructions may result in undesirable consequences, particularly hurting people and damaging property. Users who have already mounted the display on the ceiling or any other horizontal surface overhead are strongly advised to contact AG Neovo for consultations and solutions to help ensure a most pleasurable and fulfilling display experience.

# PRECAUTIONS

---

## Notice for the LCD Display

---

In order to maintain the stable luminous performance, it is recommended to use low brightness setting.

Due to the lifespan of the lamp, it is normal that the brightness quality of the LCD display may decrease with time.

When static images are displayed for long periods of time, the image may cause an imprint on the LCD display. This is called image retention or burn-in.

To prevent image retention, do any of the following:

- Set the LCD display to turn off after a few minutes of being idle.
- Use a screen saver that has moving graphics or a blank white image.
- Switch desktop backgrounds regularly.
- Adjust the LCD display to low brightness settings.
- Turn off the LCD display when the system is not in use.

Things to do when the LCD display shows image retention:

- Turn off the LCD display for extended periods of time. It can be several hours or several days.
- Use a screen saver and run it for extended periods of time.
- Use a black and white image and run it for extended periods of time.

---

When the LCD display is moved from one room to another or there is a sudden change from low to high ambient temperature, dew condensation may form on or inside the glass surface. When this happens, do not turn on the LCD display until the dew disappears.

---

Due to humid weather conditions, it is normal for mist to form inside the glass surface of the LCD display. The mist will disappear after a few days or as soon as the weather stabilizes.

---

There are millions of micro transistors inside the LCD display. It is normal for a few transistors to be damaged and to produce spots. This is acceptable and is not considered a failure.

---

The intended use of the DR-17E, DR-22E is to serve as a LCD monitor for integration with the hospital system. It is designed for general purpose for adults using at hospital environment, continuous operation. For displaying and viewing of images for reference. The use of this device does not require any direct contact with patients.

---

Accessory equipment connected to the analog and digital interfaces must be in compliance with the respective nationally harmonized IEC standards (i.e. IEC 60950 for data processing equipment, IEC 60065 for video equipment, IEC 61010-1 for laboratory equipment, and IEC 60601-1 for medical equipment.) Furthermore all configurations shall comply with the system standard IEC 60601-1. Everybody who connects additional equipment to the signal input part or signal output part configures a medical system, and is therefore, responsible that the system complies with the requirements of the system standard IEC 60601-1. The unit is for exclusive interconnection with IEC 60601-1 certified equipment in the patient environment and IEC 60XXX certified equipment outside of the patient environment. If in doubt, consult the technical services department or your local representative.

---

Grounding reliability can only be achieved when the equipment is connected to an equivalent receptacle marked "Hospital Only" or "Hospital Grade".

---

# PRECAUTIONS

---

## Notice for the LCD Display

---

Use a power cord that matches the voltage of the power outlet, which has been approved and complies with the safety standard of your particular country.

---

The single device output analog signals through ADC element (Analog DigitalConvert) conversion to become a digital signal and the video signal is via Video Decoder conversion. It has become the same digital signal, these signals via Scaler IC as zoom in or out action and digital image processing, then through the cable line transmission LVDS signals to one of the LCD module. The last by the clock controller (Timing Controller, TCON), the clock signal is transmitted to the drive IC on the panel and turn on Backlight for LCD module light source by Scaler control.

---

**WARNING** – No protection against the ingress of water : IPX0

---

**WARNING** – Do not modify this equipment without authorization of the manufacturer.

---

Installation and OSD adjusting should only be carried by manufacturer trained and authorized personnel.

---

**WARNING** – To avoid risk of electric shock, this equipment must only be connected to a supply mains with protective earth.

---

**CAUTION:** This adapter Manufacturer/model is a forming part of the medical device.

- ◆ Power by class I power supply.
  - ◆ Adapter manufacturer/model:  
ADAPTER TECH: ATM065-P240  
Input/output: 100-240V~50-60Hz, 24V(===) 2.7A.  
ADAPTER TECH: ATM065T-P240  
Input/output: 100-240V~50-60Hz, 24V(===) 2.7A.
- 

**WARNING:** Use suitable mounting apparatus to avoid risk of injury.

---

**WARNING:** The equipment not suitable for use in the presence of a flammable anesthetic mixture with air or with oxygen or nitrous: Not AP or APG Category

---

**CAUTION:** No applied part.

---

Make sure the user not to contact SIP/SOPs and the patient at the same time.

---

**CAUTION:** Transport should only be undertaken in a flat surface.

---

# CHAPTER 1: PRODUCT DESCRIPTION

## 1.1 Package Contents

When unpacking, check if the following items are included in the package. If any of them is missing or damaged, contact your dealer.

**LCD Display**

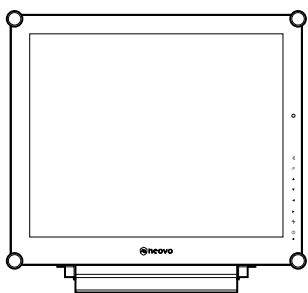

DR-17E

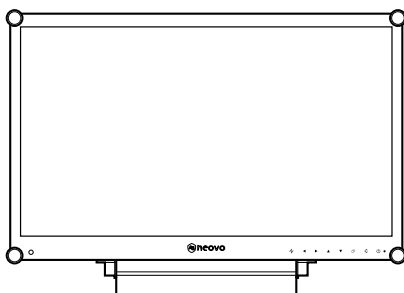

DR-22E

**Quick Start Guide**



**Power adapter**

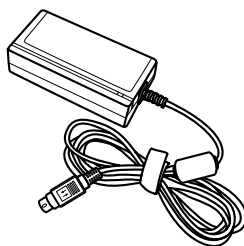

**Power cord**

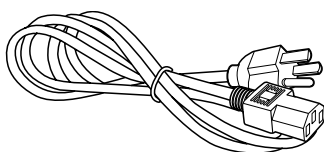

**VGA cable**

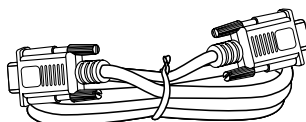

**Audio cable**

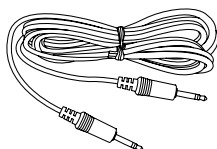

**Warranty card**

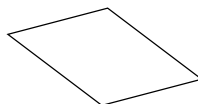

**Note:**

Must use only the supplied power adapter:

- ◆ ADAPTER TECH  
Model no.: ATM065-P240  
Rating: 24V/ 2.7A
- ◆ ADAPTER TECH  
Model no.: ATM065T-P240  
Rating: 24V/ 2.7A

**Note:**

- ◆ The pictures are for reference only. Actual items may vary upon shipment.

# PRODUCT DESCRIPTION

## 1.2 Wall Mounting Installation Preparation

### 1.2.1 Wall Mounting

#### 1 Remove the base stand.

See procedures below.

#### 2 Wall mount the LCD display.

Screw the mounting bracket to the VESA holes at the rear of the LCD display.

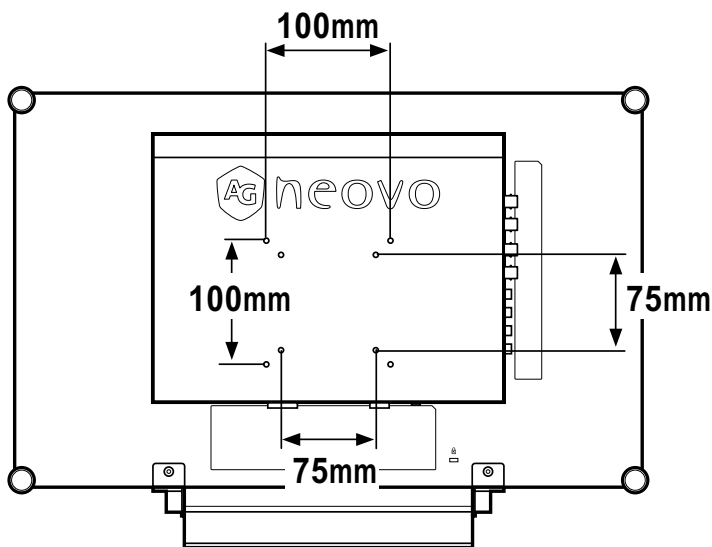

### 1.2.2 Removing the Base Stand

- 1 Carefully place the product screen side down on a cushioned surface that will protect product and screen from damage.
- 2 Remove the four screws securing the base stand from the LCD display.
- 3 Detach the base stand.
- 4 Lock four screws back.

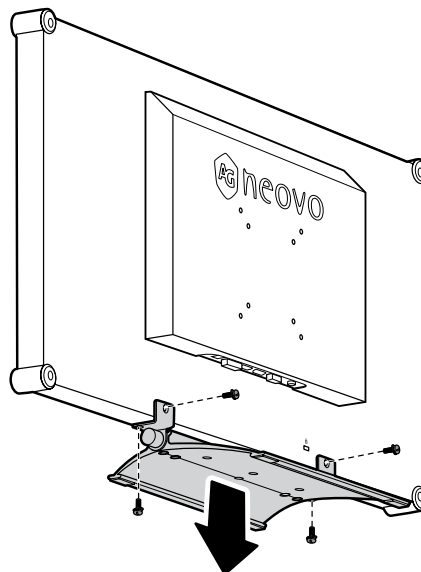

#### Note:

To protect the glass panel, place a towel or soft cloth before laying the LCD display down.

#### Note:

Use only M4 x 10 mm screws for VESA mounting.

#### Note:

Take measures to prevent the LCD display from falling down and lessen possible injury and damage to the display in case of earthquakes or other disasters.

- ◆ Use only the 75 x 75 mm and 100 x 100 mm wall mount kit recommended by AG Neovo.
- ◆ Secure the LCD display on a solid wall strong enough to bear its weight.



# PRODUCT DESCRIPTION

## 1.3 LCD Display Overview

### 1.3.1 Front View and Keypad Buttons

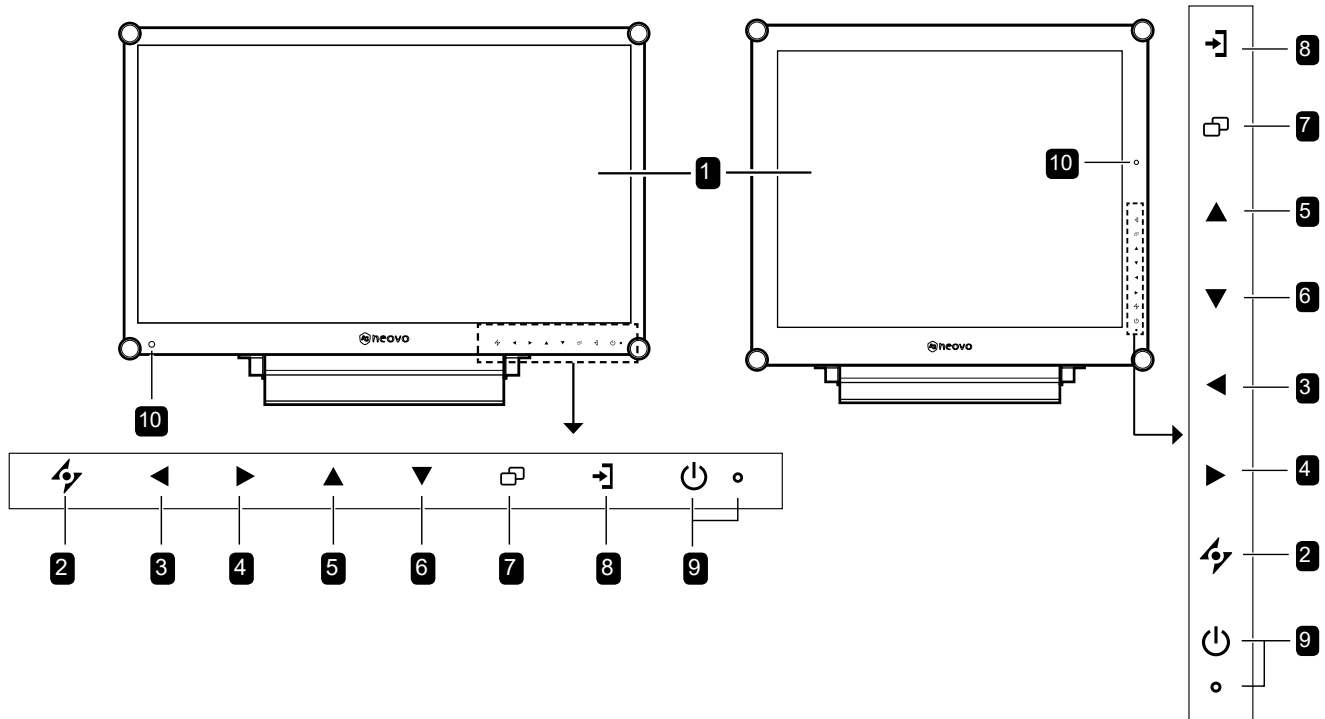

#### 1 Display screen

The LCD display screen is protected by NeoV™ Optical Glass.

#### 2 AUTO: Hotkey: For VGA input signal source, press to perform auto adjustment.

- During OSD menu selection, press to close the OSD menu or exit a submenu.

#### 3 LEFT: Hot Key: Volume Down

- Press to display the volume screen. Then press again to decrease the volume.
- During OSD menu selection, press to select an option or adjust the settings.

#### 4 RIGHT: Hot Key: Aspect Ratio

- Press to increase the volume.
- During OSD menu selection, press to select an option, adjust the settings, or enter the submenu.

#### Illuminator Function Hot Key

Press and hold ◀ and ▶ for 3 seconds to turn the screen completely white to enable you to see the light box for the x-ray film. To change the screen back to normal display mode, press and hold ◀ and ▶ for 3 seconds again.

#### 5 UP: Hot Key: Screen Freeze

- During OSD menu selection, press to select an option or adjust the settings.

#### 6 DOWN: Hot Key: Picture Mode

- During OSD menu selection, press to select an option or adjust the settings.

#### 7 MENU: Press to display/hide the OSD menu.

#### 8 SOURCE: Press to select the input signal source.

#### 9 POWER / LED indicator:

- POWER: Press to turn the power on or off.
- LED indicator:
  - Green - Power on
  - Amber - Standby mode
  - Off - Power off

#### 10 EcoSmart sensor: Detect ambient lighting conditions and automatically adjust the brightness levels. Refer to page 46 "ECO SMART" for more information.

# PRODUCT DESCRIPTION

## 1.3.2 Rear View

### DR-17E

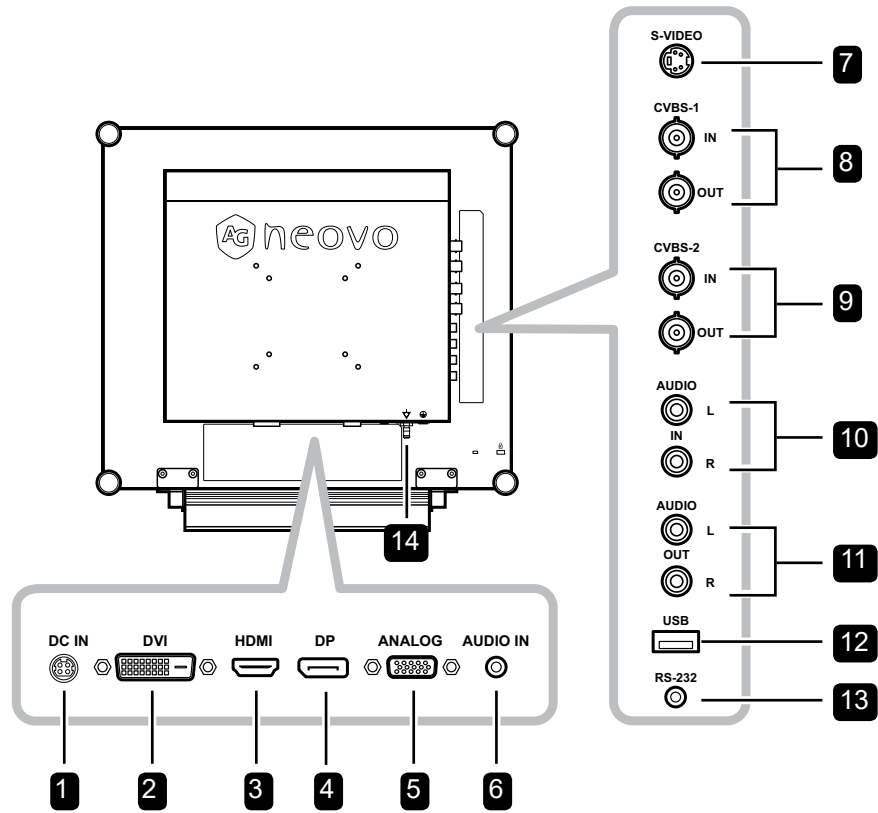

### DR-22E

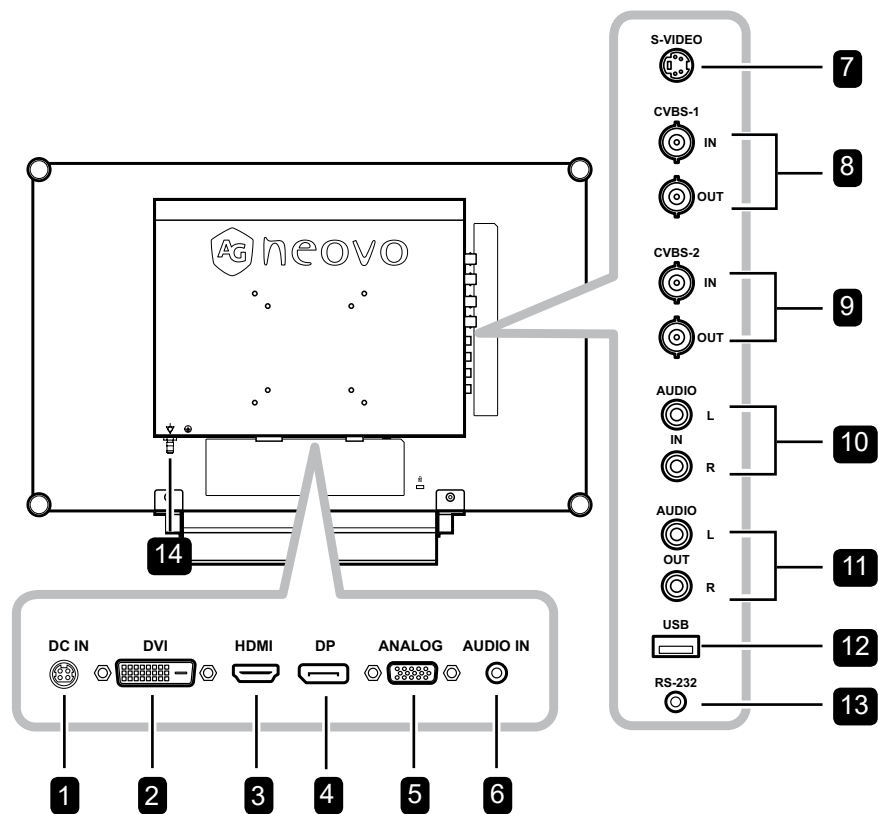

# PRODUCT DESCRIPTION

## **1 DC power input**

Use to connect the power adapter.

## **2 DVI connector**

Use to connect a PC using DVI cable for digital input signal.

## **3 HDMI connector**

Use to connect an input device using HDMI cable for digital input signal.

## **4 DP (DisplayPort) connector**

Use to connect a PC or video device using a displayport cable for digital input signal.

## **5 ANALOG (VGA) connector**

Use to connect a PC using a VGA cable for analogue input signal.

## **6 Audio in**

Use to connect an audio cable for the PC's audio input.

## **7 S-Video connector**

Use to connect S-Video cable for the S-Video signal.

## **8 COMPOSITE Video input/output connectors (1)**

Use to connect composite cables for CVBS input/output signal.

## **9 COMPOSITE Video input/output connectors (2)**

Use to connect composite cables for CVBS input/output signal.

## **10 COMPOSITE Audio input connectors**

Use to connect RCA cables for CVBS / S-Video audio signal.

## **11 COMPOSITE Audio output connectors**

Use to connect RCA cables for CVBS / S-Video audio signal.

## **12 USB connector (For F/W update)**

Use to connect a USB compatible storage device for firmware update.

## **13 RS-232 connector**

Use to connect an RS-232 cable for network input.

## **14 Potential Equalization Plug (Ø 6mm)**

# CHAPTER 2: MAKING CONNECTIONS

## 2.1 Connecting the Power

- 1 Connect the power cord to the power adapter.
- 2 Connect the power adapter to the DC power input at the rear of the LCD display.
- 3 Connect the power cord plug to a power outlet or a power supply.

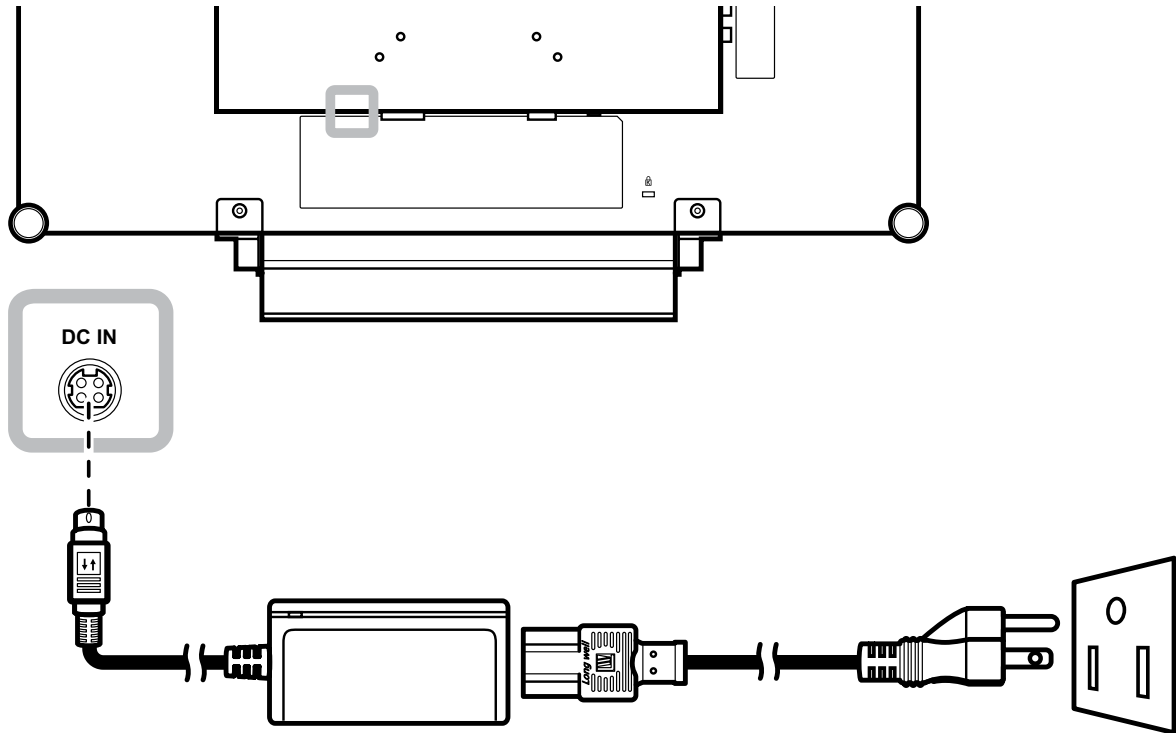

### Caution:

- ◆ Make sure that the LCD display is not connected to the power outlet before making any connections. Connecting cables while the power is ON may cause electric shock or personal injury.



### Caution:

- ◆ When unplugging the power cord, hold the power cord by the plug head. Never pull by the cord.

# MAKING CONNECTIONS

## 2.2 Connecting Input Source Signals

### 2.2.1 Connecting a Computer

#### Using DVI Cables

Connect one end of a DVI (DVI-D) cable to the DVI connector of the LCD display and the other end to the DVI connector of the computer.

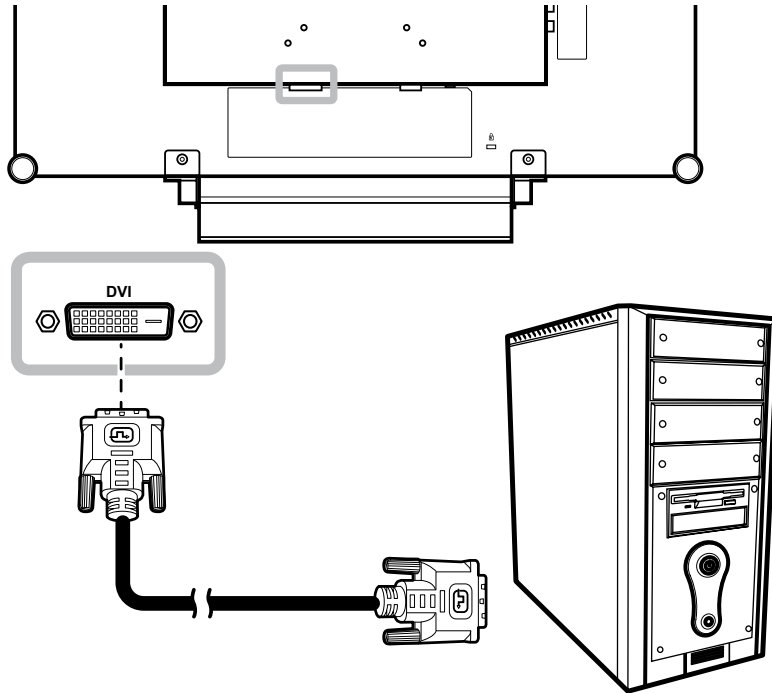

#### Using VGA Cables

Connect one end of a VGA cable to the ANALOG (VGA) connector of the LCD display and the other end to the VGA connector of the computer.

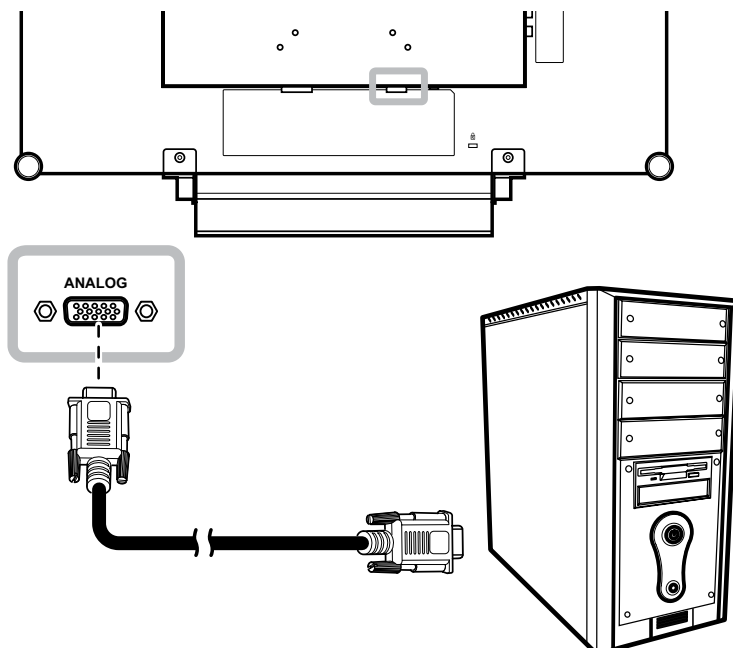

# MAKING CONNECTIONS

## Using Audio Cables

Connect one end of an audio cable to the audio port of the LCD display and the other end to the audio out port of the computer.

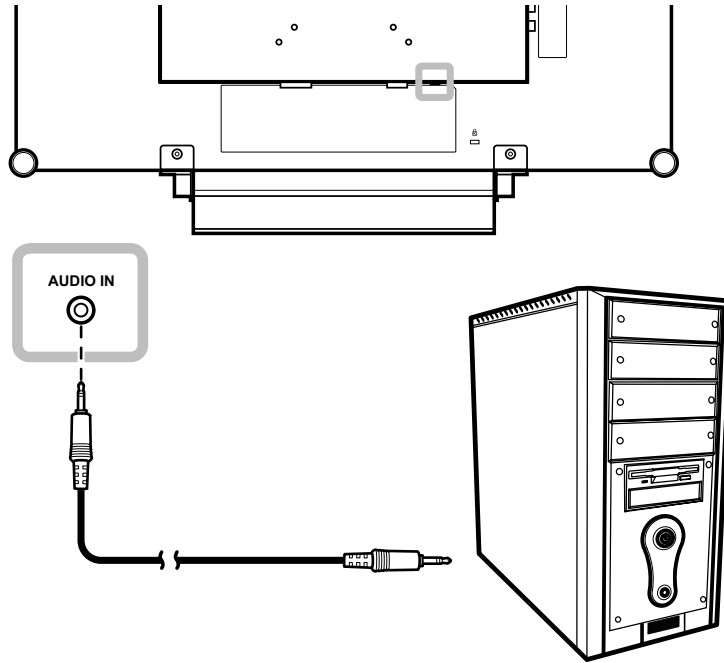

## Using RS-232 Cables

Connect one end of an RS-232 cable to the RS-232 connector of the LCD display and the other end to the RS-232 connector of the computer.

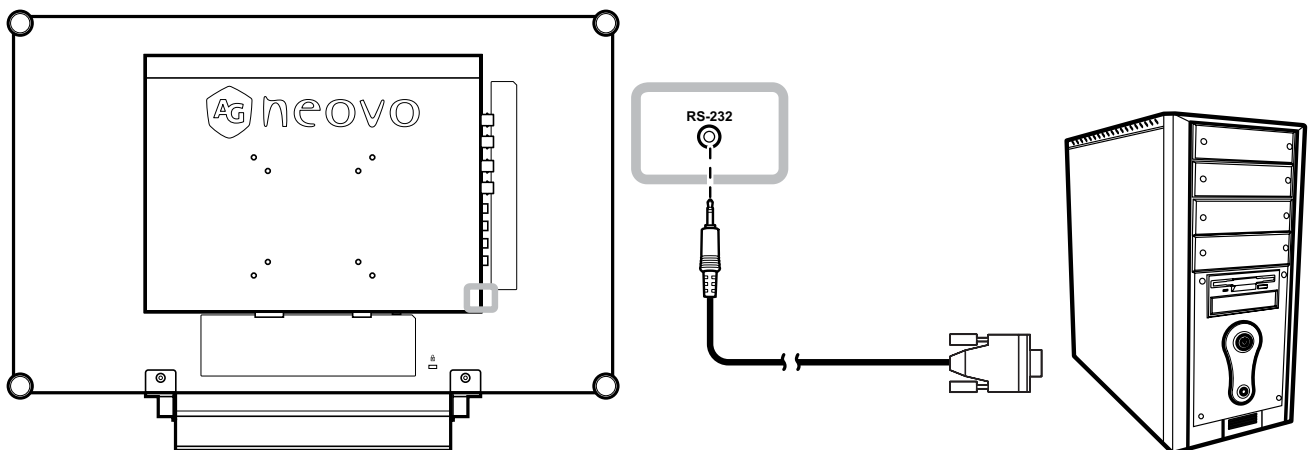

# MAKING CONNECTIONS

## 2.2.2 Connecting a Camera or Video Device

### Using S-Video Cables

Connect one end of an S-Video cable to the S-VIDEO connector of the LCD display and the other end to the S-VIDEO connector of your device.

For audio input, connect an RCA cable to the audio in connector of the LCD display and the audio out connector of your device.

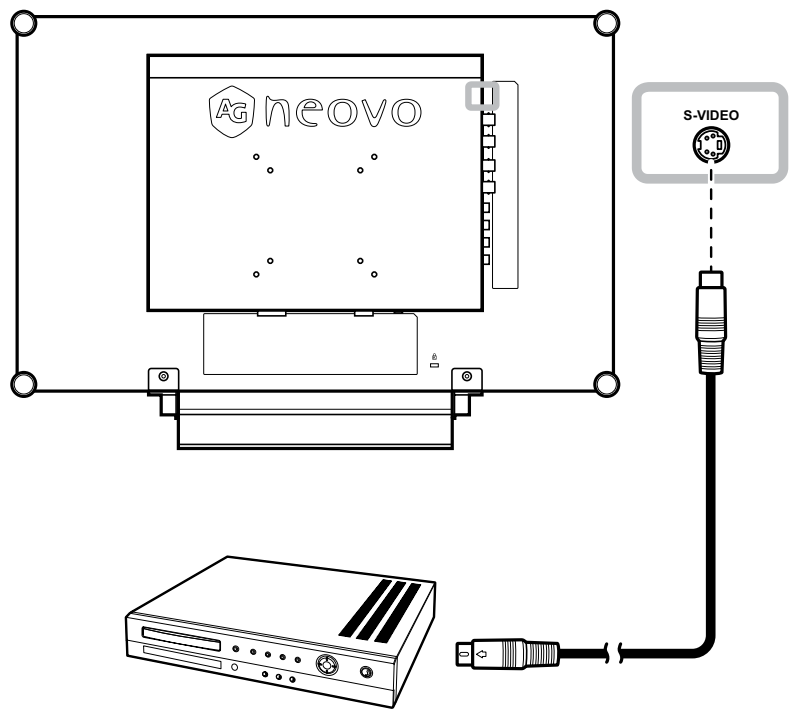

### Using CVBS Cables

Connect one end of a CVBS cable to the COMPOSITE connectors of the LCD display and the other end to the COMPOSITE connectors of your device.

For audio input, connect an RCA cable to the audio in connector of the LCD display and the audio out connector of your device.

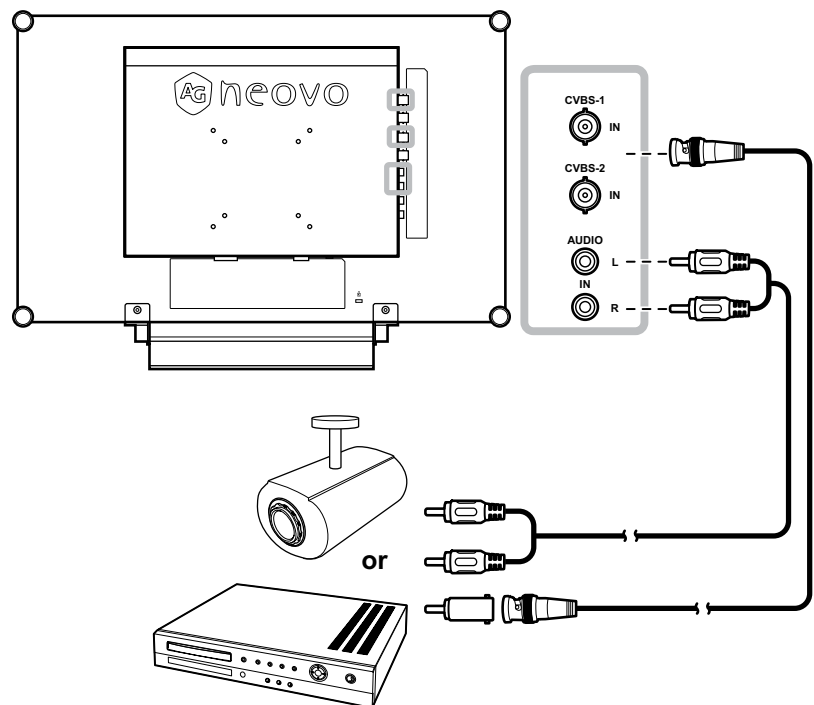

# MAKING CONNECTIONS

## Using HDMI Cables

Connect one end of an HDMI cable to the HDMI connector of the LCD display and the other end to the HDMI connector of your device.

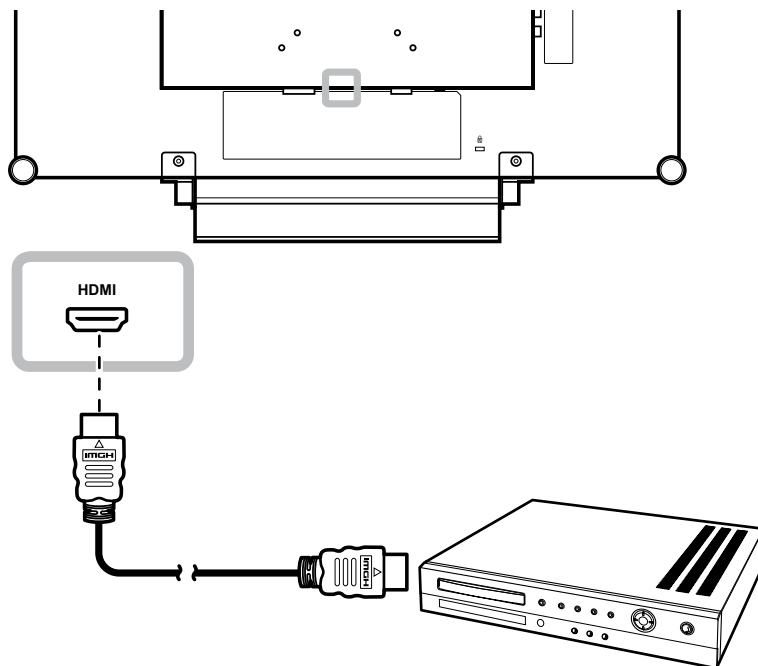

## Using DisplayPort Cables

Connect one end of a DisplayPort cable to the DP (DisplayPort) connector of the LCD display and the other end to the DisplayPort connector of your device.

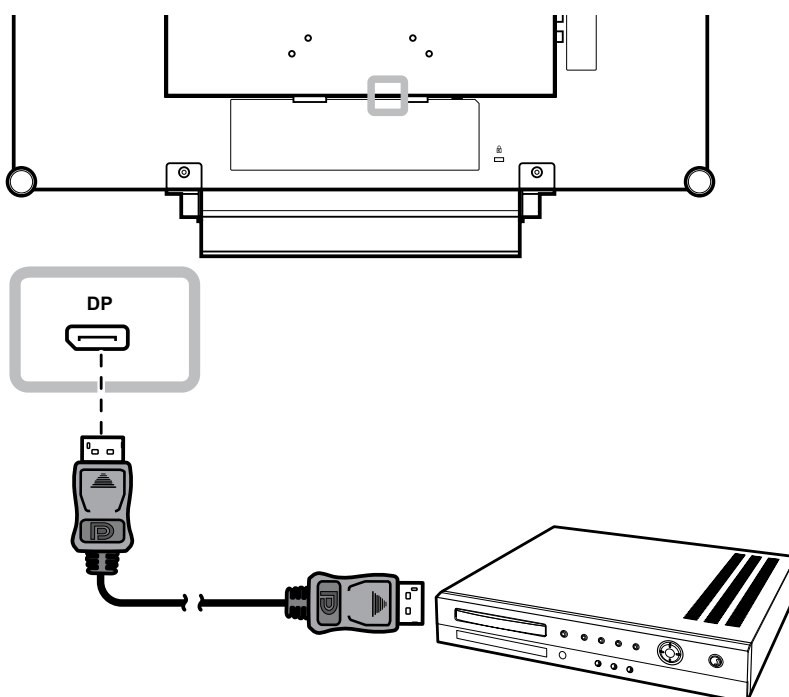



# MAKING CONNECTIONS

## 2.3 Connecting a Stereo Amplifier

To amplify the sound output, connect a stereo amplifier to the LCD display.

Connect an RCA cable to the audio out connector of the LCD display and to the audio in connector of a stereo amplifier.

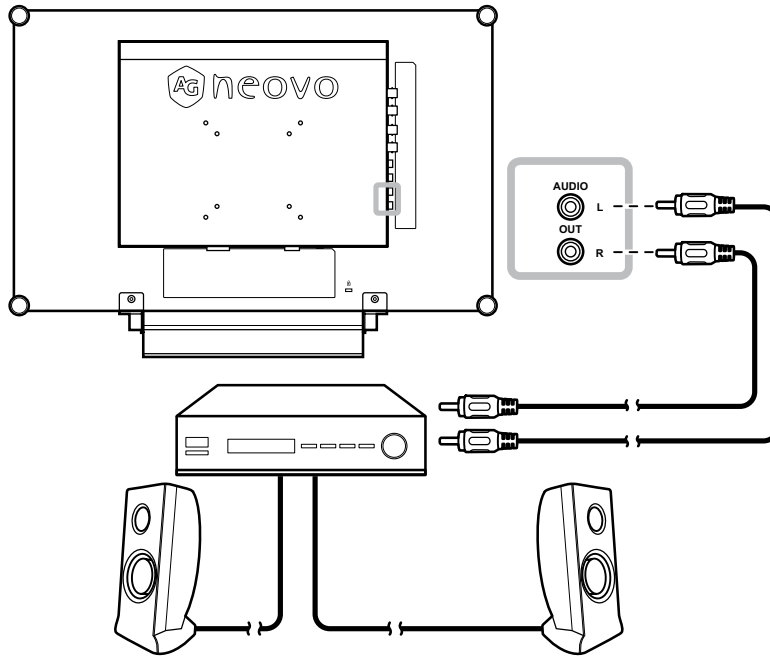

## 2.4 Connecting a USB Storage Device (For Firmware Update)

Do any of the following to connect a USB storage device to the USB connector of the LCD:

- Connect the USB storage device directly to the USB connector of the LCD (as illustrated below).

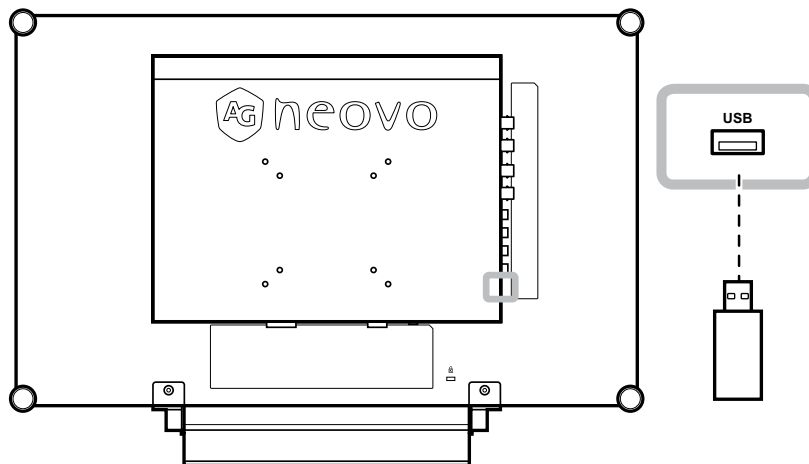

# CHAPTER 3: USING THE LCD DISPLAY

## 3.1 Turning on the Power

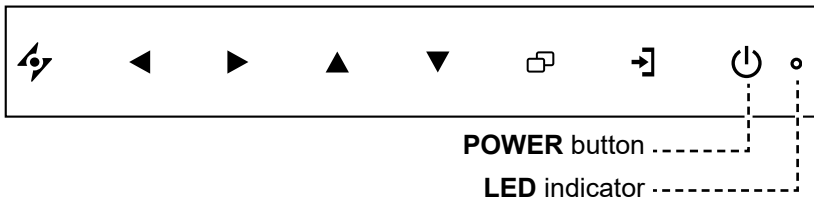

- 1 Connect the power cord to the power adapter. Then connect the power adapter to the DC power input at the rear of the LCD display.
- 2 Touch the **POWER** button to turn the LCD display on.  
The LED indicator turns GREEN.  
When the LCD display is turned on, touch the **POWER** button to turn off the LCD display.  
The LED indicator turns off.

## 3.2 Selecting the Input Source Signal

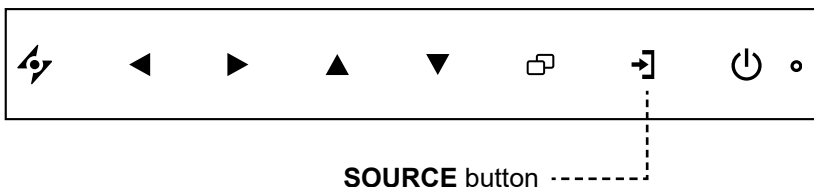

Touch the  button to select the input source signal.

### Note:

- ◆ The LCD display still consumes power as long as the power cord is connected to the power outlet. Disconnect the power cord to completely cut off power.

### Notes:

- ◆ After selecting an input source signal, the input source signal message appears on the screen briefly.  
For example, CVBS1 is selected the following message is displayed.



- ◆ If the selected input source signal is not connected to the LCD display or is turned off, the no signal message is displayed on the screen.



- ◆ If the resolution or the graphics card of the connected computer is set too high, the input out of range message is displayed.



# USING THE LCD DISPLAY

## 3.3 Adjusting the Volume / Illuminator Function Hot Key

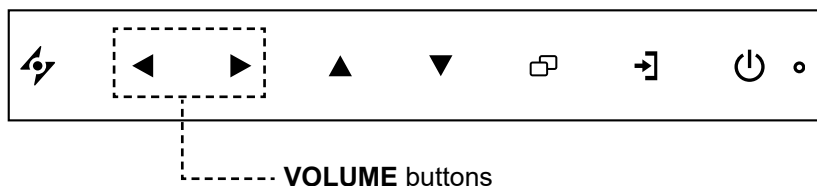

**1** Touch the ◀ buttons to call out the volume bar.



**2** Touch the ▶ button to increase volume or the ◀ button to decrease volume.

### 3.3.1 Muting the Audio

Touch the ◀ and the ▶ buttons simultaneously to mute or unmute the audio.

### Illuminator Function Hot Key

Press and hold ◀ and ▶ for 3 seconds to turn the screen completely white to enable you to see the light box for the x-ray film. To change the screen back to normal display mode, press and hold ◀ and ▶ for 3 seconds again.

## 3.4 Locking the OSD Menu

Lock the OSD menu to protect the LCD display from unauthorised users or from accidentally pressing the keypad.

To lock the OSD, press and hold the keypad buttons listed below for at least 5 seconds or until the  message appears.

When the OSD is locked, all keypad buttons are inactivated.

Type of OSD Lock	Lock Operation	Unlock Operation
Lock all buttons	Touch and hold the ▶, ▲, and the ▼ buttons for 5 seconds.	Touch and hold the ▶, ▲, and the ▼ buttons for 5 seconds or until the OSD menu appears.
Lock all buttons except the <b>POWER</b> button	Touch and hold the ◀, ▲, and the ▼ buttons for 5 seconds.	Touch and hold the ◀, ▲, and the ▼ buttons for 5 seconds or until the OSD menu appears.

# USING THE LCD DISPLAY

## 3.5 Using FREEZE Function

The FREEZE function allows you to freeze the screen image but still continues real-time playback until the image is unfreeze.

Touch the ▲ button to activate screen freeze, the screen freeze message is displayed on the screen.



Touch the ▲ button again to deactivate screen freeze.

The screen image displays the elapsed real-time playback image when screen freeze is deactivated.



## 3.6 Using Auto Adjustment Function

Auto Adjustment function automatically tunes the LCD display to its optimal setting, including horizontal position, vertical position, clock, and phase.

Touch the ⚡ button to perform auto adjustment.

The message auto adjusting is displayed on the screen.



During auto adjustment, the screen will slightly shake for a few seconds.

When the message disappears, auto adjustment is completed.

### Note:



- ◆ The FREEZE function is available only during video input signals.

### Note:

- ◆ Auto Adjustment function is available only during VGA input signals.
- ◆ It is recommended to use the auto adjustment function when using the LCD display for the first time or after a resolution or frequency change.

# CHAPTER 4: ON SCREEN DISPLAY MENU

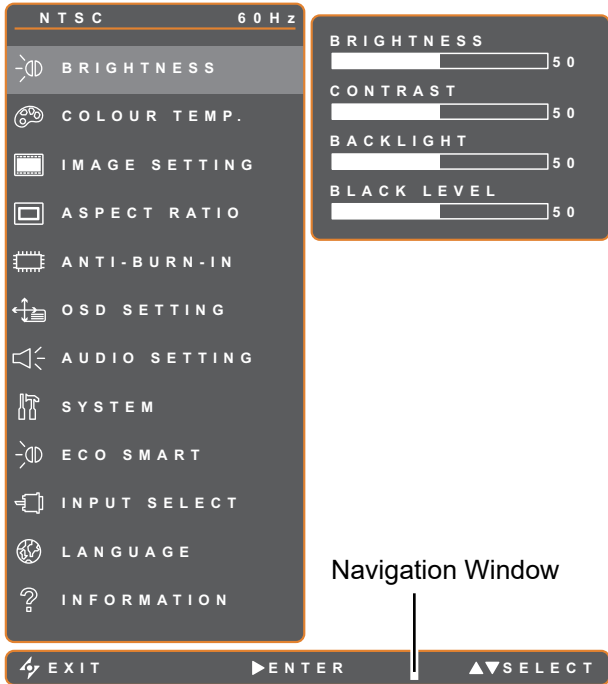
## 4.1 Using the OSD Menu

		Operation
<b>1</b>	<p>Display the main menu screen.</p> 	<p>Touch .</p>
<b>2</b>	<p>Select the menu.</p> 	<ol style="list-style-type: none"><li>1 Touch the ▲ or ▼ buttons.</li><li>2 Touch the ► button to enter the submenu.</li></ol>

# ON SCREEN DISPLAY MENU

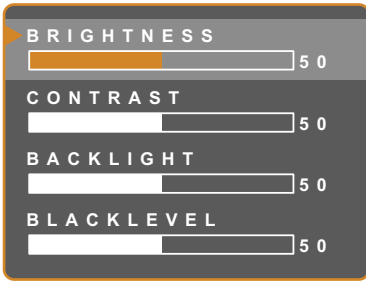
		Operation
<p><b>3</b> Select the submenu item.</p>  <p>The highlighted item with an orange arrow indicates the active submenu.</p>	<p>Touch the ▲ or ▼ buttons.</p>	
<p><b>4</b> Adjust the settings.</p>	<p>Touch the ◀ or ▶ buttons.</p>	
<p><b>5</b> Exit the submenu.</p>	<p>Touch ⚡ or ◻ to return to the previous menu.</p>	
<p><b>6</b> Close the OSD window.</p>	<p>Touch ⚡ or ◻ again.</p>	

When settings are modified, all changes are saved when the user does the following:

- Proceeds to the another menu.
- Exits the OSD menu.
- Waits for the OSD menu to disappear.

**Note:** Availability of some menu items depend on the input source signal. If the menu is not available, it is disabled and grayed out.

# ON SCREEN DISPLAY MENU

## 4.2 OSD Menu Tree

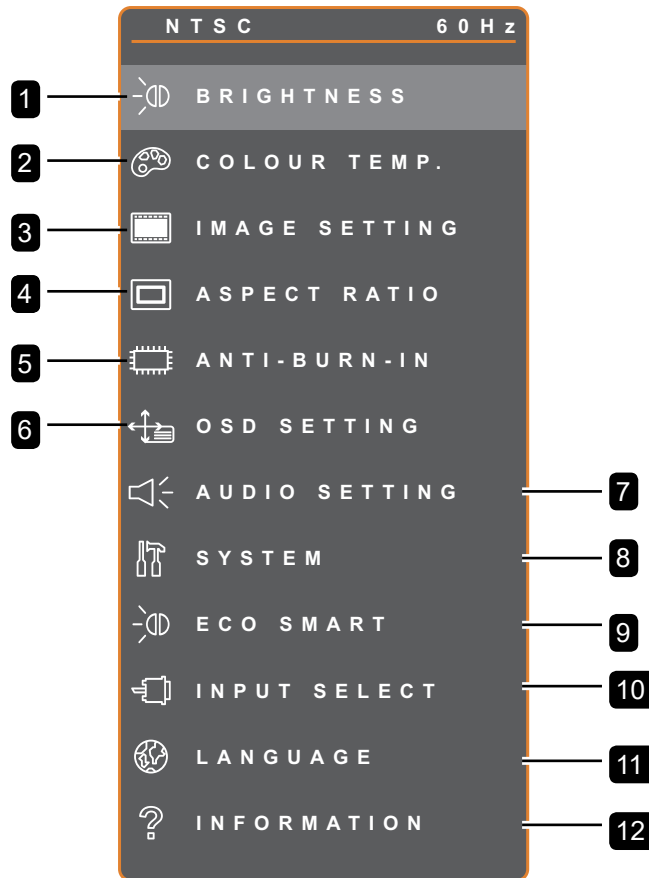

Main Menu	Submenu	Remarks
1. BRIGHTNESS	<ul style="list-style-type: none"> <li>• BRIGHTNESS</li> <li>• CONTRAST</li> <li>• BACKLIGHT</li> <li>• BLACKLEVEL</li> </ul>	Refer to pages 34-35
2. COLOUR TEMP.		Refer to page 36.
3. IMAGE SETTING	<ul style="list-style-type: none"> <li>• SHARPNESS</li> <li>• SATURATION</li> <li>• TINT</li> <li>• GAMMA</li> <li>• COLOR RANGE</li> <li>• NOISE REDUCTION</li> <li>• PICTURE MODE</li> <li>• H. POSITION</li> <li>• V. POSITION</li> <li>• PHASE</li> <li>• CLOCK</li> </ul>	Refer to pages 37-39

# ON SCREEN DISPLAY MENU

Main Menu	Submenu	Remarks
4. ASPECT RATIO	<ul style="list-style-type: none"> <li>• FULL</li> <li>• REAL</li> <li>• NATIVE</li> <li>• ZOOM</li> <li>• OVERSCAN</li> </ul>	Refer to page 40
5. ANTI-BURN-IN	<ul style="list-style-type: none"> <li>• ENABLE</li> <li>• INTERVAL (HOURS)</li> <li>• MODE</li> </ul>	Refer to page 41
6. OSD SETTING	<ul style="list-style-type: none"> <li>• TRANSPARENCY</li> <li>• OSD H. POSITION</li> <li>• OSD V. POSITION</li> <li>• OSD TIMER</li> </ul>	Refer to page 42
7. AUDIO SETTING	<ul style="list-style-type: none"> <li>• VOLUME</li> <li>• AUDIO</li> <li>• SOURCE</li> </ul>	Refer to page 43
8. SYSTEM	<ul style="list-style-type: none"> <li>• POWER SAVING</li> <li>• SOURCE DETECT</li> <li>• DDC/CI</li> <li>• DCR</li> <li>• BLUE SCREEN</li> <li>• SIGNAL INFO</li> <li>• HDMI CEC</li> <li>• LOGO</li> <li>• LED</li> <li>• MONITOR-ID</li> <li>• RECALL</li> </ul>	Refer to pages 44-45
9. ECO SMART	<ul style="list-style-type: none"> <li>• ENABLE</li> <li>• MODE</li> <li>• LEVEL</li> </ul>	Refer to page 46
10. INPUT SELECT	<ul style="list-style-type: none"> <li>• VGA</li> <li>• DVI</li> <li>• HDMI</li> <li>• DP</li> <li>• CVBS1</li> <li>• CVBS2</li> <li>• S-VIDEO</li> </ul>	Refer to page 47







# ON SCREEN DISPLAY MENU

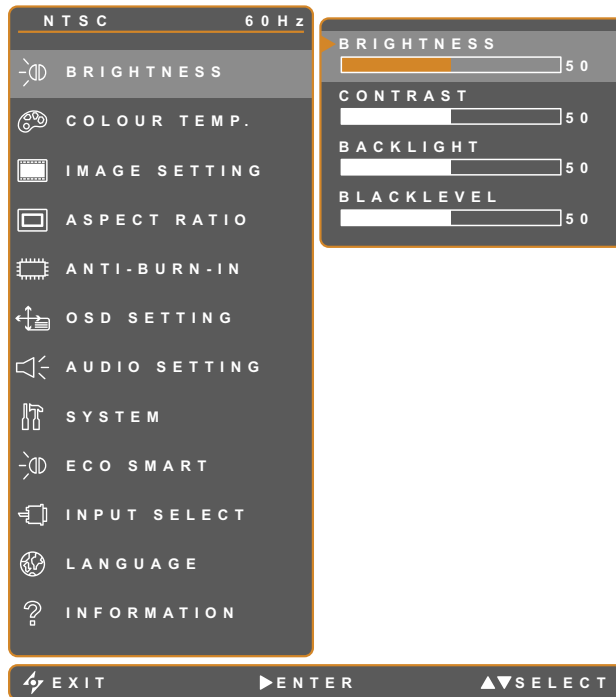

Main Menu	Submenu	Remarks
11. LANGUAGE	SELECT THE OSD LANGUAGE: EN / FR / DE / ES / IT / PY / RO / PL / CS / NL / 简中 / 繁中	
12. INFORMATION	Displays settings information such as Input, Resolution, Horizontal and Vertical Frequency, Timing mode, and Firmware version.	

# CHAPTER 5: ADJUSTING THE LCD DISPLAY

## 5.1 BRIGHTNESS



1. Touch  to call out the OSD window.
2. Select **BRIGHTNESS** menu, then touch the  button.
3. Touch the  or  button to select an option.

Item	Function	Operation	Range
BRIGHTNESS	Adjusts the luminance of the screen image.		
CONTRAST	Adjusts the difference between the black level and the white level.		
BACKLIGHT	Adjusts the luminance of the screen image. <b>Note:</b> This menu option is not available if the <b>ECO SMART</b> function is enabled.	Touch the  or  button to adjust the value.	0 to 100
BLACKLEVEL	Adjusts the black level of the screen image. Low brightness setting makes black colour darker. <b>Note:</b> This menu option is not available if the input source is VGA or DVI.		

Refer to comparison illustrations on page 28.





# ADJUSTING THE LCD DISPLAY









	Original Setting	High Setting	Low Setting
BRIGHTNESS			
CONTRAST			
BLACK LEVEL			

# ADJUSTING THE LCD DISPLAY

## 5.2 COLOUR TEMP.







1. Touch  to call out the OSD window.
2. Select **COLOUR TEMP.** menu, then touch the  button.
3. Touch the  or  button to select an option.



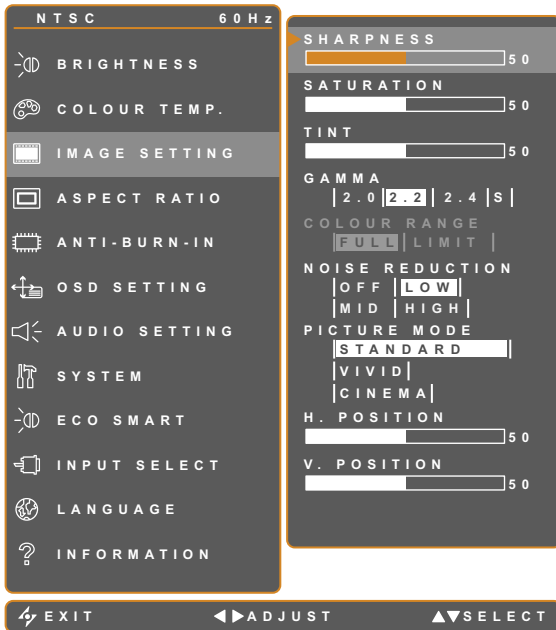





Item	Function	Operation	Value
COLOUR TEMP.	Provides several colour settings	Touch the  or  button to select the setting.	NEUTRAL WARM COOL USER AUTO COLOUR
	<p>Colour setting can be set to:</p> <ul style="list-style-type: none"> <li>• <b>NEUTRAL</b> - Commonly used for normal lighting conditions.</li> <li>• <b>WARM</b> - Applies a reddish tint for warmer colours.</li> <li>• <b>COOL</b> - Applies a bluish tint for cooler colours.</li> <li>• <b>USER</b> - This allows users to set the colour temperature by adjusting the R, G, B settings according to one's preference.                             <ol style="list-style-type: none"> <li>1 Select <b>USER</b>, then touch the  button</li> <li>2 Touch the  or  button to select among R, G, B option.</li> <li>3 Touch the  or  button to adjust the values between 0 ~ 255.</li> </ol> <p><b>Note:</b> Activate <b>RECALL</b> to return the colour to its default setting.</p> </li> <li>• <b>AUTO COLOUR</b> - Operates the white balance and automatically adjusts the colour settings.                             <ol style="list-style-type: none"> <li>1 Select <b>AUTO COLOUR</b>.</li> <li>2 Touch the  button to activate auto colour.</li> </ol> <p><b>Note:</b> This menu option is only available if the input source is VGA.</p> </li> </ul>		

# ADJUSTING THE LCD DISPLAY



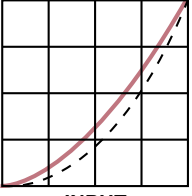
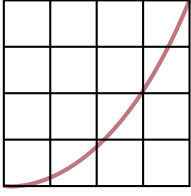
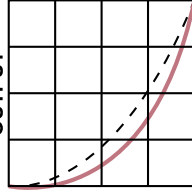
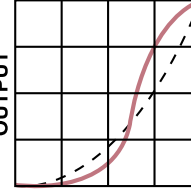



## 5.3 IMAGE SETTING



1. Touch  to call out the OSD window.
2. Select **IMAGE SETTING** menu, then touch the  button.
3. Touch the  or  button to select an option.

Item	Function	Operation	Range
SHARPNESS	Adjusts the clarity and focus of the screen image.	Touch the  or  button to adjust the value.	0 to 100
SATURATION	Adjusts the colour saturation.		
TINT	Adjusts the colour tint.		
GAMMA	Adjusts the non-linear setting for picture luminance and contrast.	Touch the  or  button to select the setting.	2.0
			2.2
			2.4
			S
	   		
	   		

# ADJUSTING THE LCD DISPLAY

Item	Function	Operation	Range	
COLOUR RANGE	Adjusts black and white levels for video. <b>Note:</b> This menu option is only available if the input source is HDMI or DP.	Touch the ◀ or ▶ button to select the setting.	FULL LIMIT	
	Signal source from PC - PC signal at a full range (Grayscale 0-255) state:			
				
	Monitor OSD colour range: Full *Please select	Monitor OSD colour range: Limit		
NOISE REDUCTION	Adjusts the noise reduction to help remove noise from images. This helps produce clearer and crisper images.	Touch the ◀ or ▶ button to select the setting.	OFF LOW MID HIGH	
	Signal source from Video - Video signal at a limited range (Grayscale 16-235) state:			
				
	Monitor OSD colour range: Limit *Please select	Monitor OSD colour range: Full		
NOISE REDUCTION				
	Noise Reduction Off	Noise Reduction On		
PICTURE MODE	Selects a predefined picture mode setting.	Touch the ◀ or ▶ button to select the setting.	STANDARD VIVID CINEMA	

# ADJUSTING THE LCD DISPLAY

Item	Function	Operation	Range
H. POSITION (Horizontal Position)	Moves the screen image to the left or right.	Touch the ◀ or ▶ button to adjust the value.	0 to 100
V. POSITION (Vertical Position)	Moves the screen image up or down.		
PHASE	Adjusts the phase timing to synchronise with the video signal. <b>Note:</b> This menu option is only available if the input source is VGA.		
CLOCK	Adjusts the frequency timing to synchronise with the video signal. <b>Note:</b> This menu option is only available if the input source is VGA.		

\* Each item function might vary for different input sources under different picture modes.





Picture Mode	Item	VGA	DVI	VIDEO/ HD	S-VIDEO	HDMI	SDI	DP
STANDARD	SHARPNESS	V	V	V	V	V	V	V
	SATURATION	X	X	V	V	X	V	X
	TINT	X	X	V	V	X	V	X
	GAMMA	V	V	V	V	V	V	V
	COLOR RANGE	X	X	X	X	X	V	X
	NOISE REDUCTION	X	X	V	V	X	V	X
	PICTURE MODE	V	V	V	V	V	V	V
	H. POSITION	V	V	V	V	V	V	V
	V. POSITION	V	V	V	V	V	V	V
	PHASE	V	X	X	X	X	X	X
CLOCK	V	X	X	X	X	X	X	
VIVID / CINEMA	SHARPNESS	V	V	V	V	V	V	V
	SATURATION	V	V	V	V	V	V	V
	TINT	V	V	V	V	V	V	V
	NOISE REDUCTION	V	V	V	V	V	V	V
	PICTURE MODE	V	V	V	V	V	V	V
	H. POSITION	V	V	V	V	V	V	V
	V. POSITION	V	V	V	V	V	V	V
	PHASE	V	X	X	X	X	X	X
CLOCK	V	X	X	X	X	X	X	
VIVID	GAMMA	2.2	2.2	2.2	2.2	2.2	2.2	2.2
	COLOR RANGE	X	X	X	X	V	V	V
CINEMA	GAMMA	S	S	S	S	S	S	S
	COLOR RANGE	X	X	V	X	V	V	V





V Enable / X Disable

# ADJUSTING THE LCD DISPLAY

## 5.4 ASPECT RATIO



1. Touch  to call out the OSD window.
2. Select **ASPECT RATIO** menu, then touch the  button.
3. Touch the  or  button to select an option.

Item	Function	Operation	Value
ASPECT RATIO	Adjusts the aspect ratio of the screen image.	Touch the  or  button to select the setting.	FULL REAL NATIVE ZOOM
H. ZOOM (Horizontal Zoom)	Adjusts the horizontal zoom. <b>Note:</b> This menu option is only available if the <b>ASPECT RATIO</b> setting is set to <b>ZOOM</b> .	Touch the  or  button to adjust the value.	0 to 100
V. ZOOM (Vertical Zoom)	Adjusts the horizontal zoom. <b>Note:</b> This menu option is only available if the <b>ASPECT RATIO</b> setting is set to <b>ZOOM</b> .		
OVERSCAN	Adjusts the overscan setting to fix the cut-off screen edges.		

\* ASPECT RATIO function might vary for each input sources under different picture modes.

Picture Mode	VGA	DVI	VIDEO/HD	S-VIDEO	HDMI	SDI	DP
STANDARD	X	X	V	V	X	V	V
VIVID	V	V	V	V	V	V	V
CINEMA	V	V	V	V	V	V	V





V Enable / X Disable





# ADJUSTING THE LCD DISPLAY

## 5.5 ANTI-BURN-IN







1. Touch  to call out the OSD window.
2. Select **ANTI-BURN-IN** menu, then touch the  button.
3. Touch the  or  button to select an option.



Item	Function	Operation	Value
ENABLE	Enables or disables Anti-Burn-In function.	Touch the  or  button to select the setting.	ON OFF
INTERVAL (HOURS)	Sets the interval time (hour) between activating the Anti-Burn-In function.		4 5 6 8
MODE	Selects the Anti-Burn-In mode.  Anti-Burn-In mode can be set to. <ul style="list-style-type: none"> <li>• <b>A</b> - Executes fast.</li> <li>• <b>B</b> - Slower but more precise than mode A.</li> <li>• <b>C</b> - Slowest but the most precise anti-burn-in mode.</li> </ul>		A B C

# ADJUSTING THE LCD DISPLAY

## 5.6 OSD SETTING







1. Touch  to call out the OSD window.
2. Select **OSD SETTING** menu, then touch the  button.
3. Touch the  or  button to select an option.





Item	Function	Operation	Range
TRANSPARENCY	Adjusts the transparency level of the OSD screen.	Touch the  or  button to adjust the value.	0 to 100
OSD H. POSITION (Horizontal Position)	Moves the OSD window to the left or right of the screen.		
OSD V. POSITION (Vertical Position)	Moves the OSD window up or down the screen.		
OSD TIMER	Sets the length of time (in seconds) the OSD screen is displayed. When the time elapses, the OSD screen is automatically inactivated.		5 to 100

# ADJUSTING THE LCD DISPLAY

## 5.7 AUDIO SETTING







1. Touch  to call out the OSD window.
2. Select **AUDIO SETTING** menu, then touch the  button.
3. Touch the  or  button to select an option.

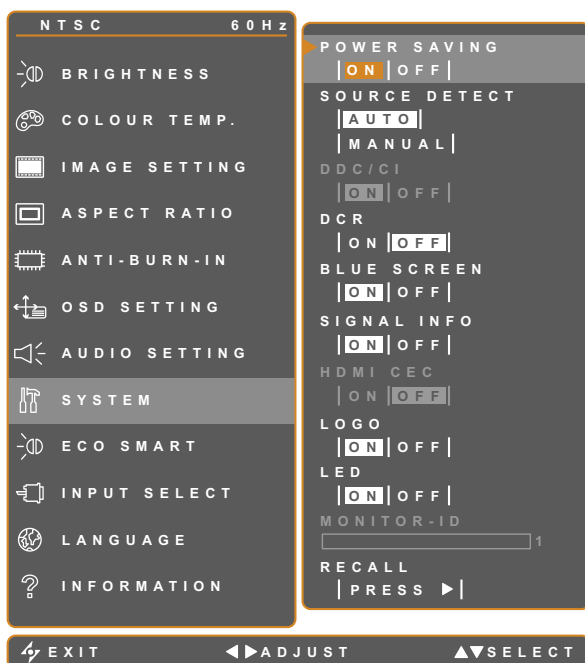

Item	Function	Operation	Range / Value
VOLUME	Adjusts the volume level of the built-in speaker. <b>Note:</b> If volume is adjusted but <b>AUDIO</b> is set to <b>OFF</b> , no sound comes out from the speaker.	Touch the  or  button to adjust the value.	0 to 100
AUDIO	Turns the audio speaker ON or OFF.		ON OFF
SOURCE	Selects the audio source for the PC or Video input signal. <b>Note:</b> This menu option is only available if the input source is HDMI or SDI.	Touch the  or  button to select the value.	PC VIDEO

# ADJUSTING THE LCD DISPLAY

## 5.8 SYSTEM



1. Touch  to call out the OSD window.
2. Select **SYSTEM** menu, then touch the  button.
3. Touch the  or  button to select an option.

Item	Function	Operation	Range / Value
POWER SAVING	Enables or disables power saving mode. When the LCD display turns into power saving mode, the screen turns black and the LED indicator lights AMBER.  <b>Note:</b> The amount of time for the display to enter power saving varies depending on the SOURCE DETECT setting. If the SOURCE DETECT is set to <b>AUTO</b> , the display checks all input source signals before entering power saving mode if no signal is detected; this takes up more time. If the SOURCE DETECT is set to <b>MANUAL</b> , the display enters power saving mode right away.	Touch the  or  button to select the setting.	ON OFF
SOURCE DETECT	Sets the display to automatically or manually detect the input source signal.		AUTO MANUAL
DDC/CI	Activates the DDC/CI protocol to allow users to configure the monitor by a software using two wires on the VGA, DVI, HDMI, SDI, or DP cables.		ON OFF
DCR (Dynamic Contrast Ratio)	Activates DCR. This feature provides automatic adjustment of picture brightness and contrast at high speed and dynamic contrast range, such as when watching movies. DCR is suitable for indoor viewing.		ON OFF

# ADJUSTING THE LCD DISPLAY





Item	Function	Operation	Range / Value
BLUE SCREEN	Enables or disables the blue screen feature. If the setting is set to <b>ON</b> , it displays a blue screen when no signal is available	Touch the ◀ or ▶ button to select the setting.	ON OFF
SIGNAL INFO	Enables or disables the signal information to be displayed on the screen		
HDMI CEC	Enables or disables the HDMI CEC feature. If the setting is set to <b>ON</b> , you can control the connected HDMI CEC-compatible device on the same power on or power off status. <b>Note:</b> This menu option is only available if the input source is HDMI or DP.		
LOGO	Enables or disables the logo feature. If the setting is set to <b>ON</b> , the AG Neovo logo is briefly displayed after the display is powered on.		
LED	Turns the LED indicator on or off while using the LCD monitor.		
MONITOR-ID	Sets the monitor ID.	Touch the ◀ or ▶ button to set the ID.	0-255
RECALL	Use to recall all to default settings, except Language and the input source.	Touch the ▶ button to execute the function.	



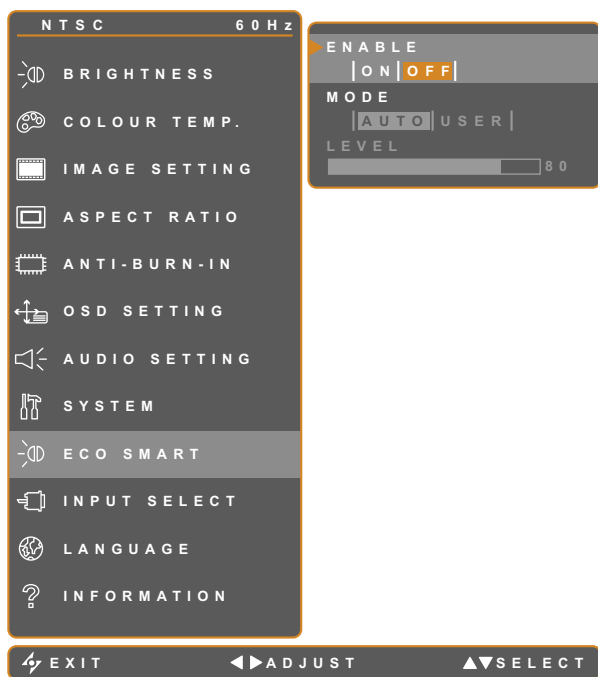

# ADJUSTING THE LCD DISPLAY

## 5.9 ECO SMART

With the built-in EcoSmart sensor, users can enable the Eco Smart feature to automatically adjust the LCD screen brightness according to the ambient light. This feature comforts the eyes and helps optimise energy efficiency.







1. Touch  to call out the OSD window.
2. Select **ECO SMART** menu, then touch the  button.
3. Touch the  or  button to select an option.

Item	Function	Operation	Value
ENABLE	Enables or disables the Eco Smart feature.	Touch the  or  button to select the value.	ON OFF
MODE	Sets the auto brightness mode.		AUTO USER
	The mode can be set to: <ul style="list-style-type: none"> <li>• <b>AUTO</b> - This mode is the default mode. The LCD brightness automatically adjusts to the ambient brightness.</li> <li>• <b>USER</b> - Allows you to manually adjust the LCD brightness.</li> </ul>		
LEVEL	Allows you to set the level of LCD brightness. <b>Note:</b> This menu option is only available if the MODE setting is set to <b>USER</b> .	Touch the  or  buttons to adjust the value.	0 to 100

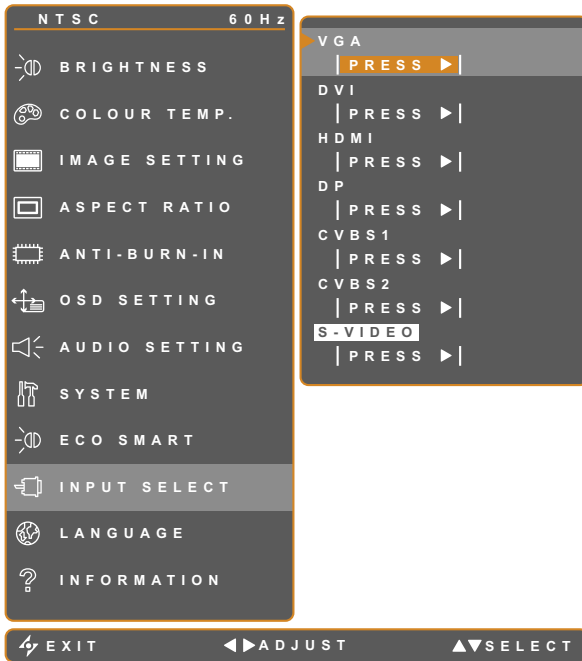
# ADJUSTING THE LCD DISPLAY

## 5.10 INPUT SELECT







1. Touch  to call out the OSD window.
2. Select **INPUT SELECT** menu, then touch the  button.
3. Touch the  or  button to select an option.

Item	Function	Operation	Value
VGA	Sets VGA as the input source signal.	Touch the  button to select the input source.	-
DVI	Sets DVI as the input source signal.		
HDMI	Sets HDMI as the input source signal.		
DP	Sets DP (DisplayPort) as the input source signal.		
CVBS1	Sets CVBS1 as the input source signal.		
CVBS2	Sets CVBS2 as the input source signal.		
S-VIDEO	Sets S-Video as the input source signal.		

# CHAPTER 6: APPENDIX

## 6.1 Warning Messages

Warning Messages	Cause	Solution
	<p>The resolution or the refresh rate of the graphics card of the computer is set too high.</p>	<ul style="list-style-type: none"> <li>• Change the resolution or the refresh rate of the graphics card.</li> </ul>
	<p>The LCD display cannot detect the input source signal.</p>	<ul style="list-style-type: none"> <li>• Check if the input source is turned ON.</li> <li>• Check if the signal cable is properly connected.</li> <li>• Check if any pin inside the cable connector is twisted or broken.</li> </ul>
	<p>The OSD has been locked by the user.</p>	<ul style="list-style-type: none"> <li>• Unlock the OSD, refer to page 20.</li> </ul>
	<p>The Anti-Burn-In function has been enabled by the user.</p>	<ul style="list-style-type: none"> <li>• Disable Anti-Burn-In function, refer to page 34.</li> </ul>
	<p>The Anti-Burn-In function has been disabled by the user.</p>	<ul style="list-style-type: none"> <li>• Enable Anti-Burn-In function, refer to page 34.</li> </ul>



# APPENDIX

## 6.2 Troubleshooting

Problem	Possible Cause and Solution
No picture. <ul style="list-style-type: none"> <li>LED indicator is OFF.</li> </ul>	<ul style="list-style-type: none"> <li>Check if the LCD display is turned ON.</li> <li>Check if the power adapter is properly connected to the LCD display.</li> <li>Check if the power cord is plugged into the power outlet.</li> </ul>
<ul style="list-style-type: none"> <li>LED indicator is AMBER.</li> </ul>	<ul style="list-style-type: none"> <li>Check if the computer is turned ON.</li> <li>Check if the computer is in standby mode, move the mouse or press any key to wake up the computer.</li> </ul>
Image position is incorrect.	<ul style="list-style-type: none"> <li>Adjust the H. POSITION and V. POSITION values. Refer to IMAGE SETTING on 30.</li> </ul>
The displayed texts are blurry.	<ul style="list-style-type: none"> <li>For VGA input, touch  on the keypad to auto-adjust the display.</li> <li>Adjust the IMAGE SSETTING, refer to 30.</li> </ul>
The OSD menu can't be called out.	<ul style="list-style-type: none"> <li>The OSD is locked. To unlock the OSD, refer to page 20.</li> </ul>
Red, blue, green, white dots appear on screen.	<ul style="list-style-type: none"> <li>There are millions of micro transistors inside the LCD display. It is normal for a few transistors to be damaged and to produce spots. This is acceptable and is not considered a failure.</li> </ul>
No audio output.	<ul style="list-style-type: none"> <li>Check if the volume is set to 0, refer to Audio Mute on page 21.</li> <li>Check if the <b>AUDIO SETTING &gt; AUDIO</b> setting is set to <b>OFF</b> (refer to page 36).</li> <li>For VGA or DVI input, check the audio setting of the computer.</li> <li>For HDMI or DP input, select the correct audio input source, refer to page 40.</li> </ul>
Cannot adjust backlight setting.	<ul style="list-style-type: none"> <li>The Eco Smart feature is enabled. Set the <b>ECO SMART &gt; ENABLE</b> setting to <b>OFF</b> to disable the Eco Smart feature, refer to page 39.</li> </ul>
The displayed picture looks distorted.	<ul style="list-style-type: none"> <li>Adjust the aspect ratio, refer to 33.</li> </ul>
Dew formed on or inside the LCD display.	<ul style="list-style-type: none"> <li>This normally happens when the LCD display is moved a cold room to a hot room temperature. Do not turn ON the LCD display, wait for the dew condensation to disappear.</li> </ul>
Mist formed inside the glass surface.	<ul style="list-style-type: none"> <li>This happens due to humid weather conditions. This is a normal occurrence. The mist will disappear after a few days or as soon as the weather stabilizes</li> </ul>
Faint shadows from a static image appear on the screen.	<ul style="list-style-type: none"> <li>Turn off the LCD display for extended periods of time.</li> <li>Use a screen saver or a black and white image and run it for extended periods of time.</li> </ul>

# APPENDIX

## 6.3 Transporting the LCD Display

To transport the LCD display for repair or shipment, place the display in its original packaging carton.

- 1 Place the two foam cushions on each side of the LCD display for protection.**
- 2 Place the LCD display down in the box.**
- 3 Place the accessories on the designated area (if necessary).**
- 4 Close and tape the box.**

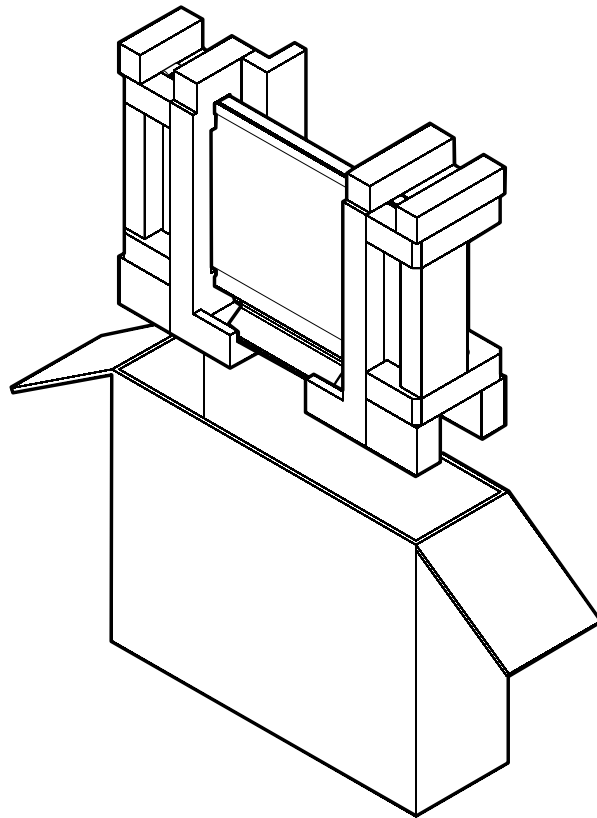

# CHAPTER 7: SPECIFICATIONS

## 7.1 Display Specifications

		DR-17E	DR-22E
Panel	Panel Type	LED-Backlit TFT LCD (TN Technology)	LED-Backlit TFT LCD (VA Technology)
	Panel Size	17.0"	21.5"
	Max. Resolution	SXGA 1280 x 1024	FHD 1920 x 1080
	Pixel Pitch	0.264 mm	0.248 mm
	Brightness	250 cd/m <sup>2</sup>	250 cd/m <sup>2</sup>
	Contrast Ratio	20,000,000:1 (DCR)	20,000,000:1 (DCR)
	Viewing Angle (H/V)	170°/160°	178°/178°
	Display Colour	16.7M	16.7M
	Response Time	3 ms	5 ms
Frequency (H/V)	H Freq.	24 kHz-81 kHz	24 kHz-83 kHz
	V Freq.	50 Hz-75 Hz	50 Hz-75 Hz
Input	DisplayPort	x 1	x 1
	HDMI	1.4 x 1	1.4 x 1
	DVI	24-Pin DVI-D	24-Pin DVI-D
	VGA	15-Pin D-Sub x 1	15-Pin D-Sub x 1
	Composite	BNC x 2	BNC x 2
	S-Video	4-Pin mini DIN x 1	4-Pin mini DIN x 1
Output	Composite	BNC x 2	BNC x 2
External Control	RS232 In	2.5 mm Phone Jack	2.5 mm Phone Jack
Other Connectivity	USB	2.0 x 1 (Service Port)	2.0 x 1 (Service Port)
Audio	Audio In	Stereo Audio Jack (3.5 mm) x 1 Stereo Audio Jack (RCA) x 1	Stereo Audio Jack (3.5 mm) x 1 Stereo Audio Jack (RCA) x 1
	Audio Out	Stereo Audio Jack (RCA) x 1	Stereo Audio Jack (RCA) x 1
	Internal Speakers	2W x 2	2W x 2
Power	Power Supply	External	External
	Power Requirements	DC 24V, 1A	DC 24V, 1.5A
	On Mode	14W (On)	15W (On)
	Stand-by Mode	< 0.7W	< 0.7W
	Off Mode	< 0.7W	< 0.7W
Glass	Thickness	3.0 mm (0.12")	3.0 mm (0.12")
	Reflection Rate	< 1%	< 1%
	Transmission Rate	> 97%	> 97%
	Hardness	> 9H	> 9H
Operating Conditions	Temperature	0°C-40°C (32°F-104°F)	0°C-40°C (32°F-104°F)
	Humidity	10%-90% (non-condensing)	10%-90% (non-condensing)
Storage Conditions	Temperature	-20°C-60°C (-4°F-140°F)	-20°C-60°C (-4°F-140°F)
	Humidity	5%-95% (non-condensing)	5%-95% (non-condensing)
Mounting	VESA FPMPI	Yes (100 x 100 mm & 75 x 75 mm)	Yes (100 x 100 mm & 75 x 75 mm)
Stand	Tilt	0° to 22°	0° to 15°
Security	Kensington Security Slot	Yes	Yes
Dimensions	Product with Base (W x H x D)	409.4 x 398.2 x 175.0 mm (16.1" x 15.7" x 6.9")	513.2 x 368.5 x 155.0 mm (20.2" x 14.5" x 6.1")
	Packaging (W x H x D)	510.0 x 493.0 x 224.0 mm (20.0" x 19.4" x 8.8")	615.0 x 483.0 x 210.0 mm (24.2" x 19.1" x 8.3")
Weight	Product with Base	6.1 kg (13.4 lb)	6.8 kg (15.0 lb)
	Packaging	8.2 kg (18.1 lb)	9.3 kg (20.5 lb)

### Note:

- ◆ All specifications are subject to change without prior notice.

# SPECIFICATIONS

## 7.2 Display Dimensions

### 7.2.1 DR-17E Dimensions

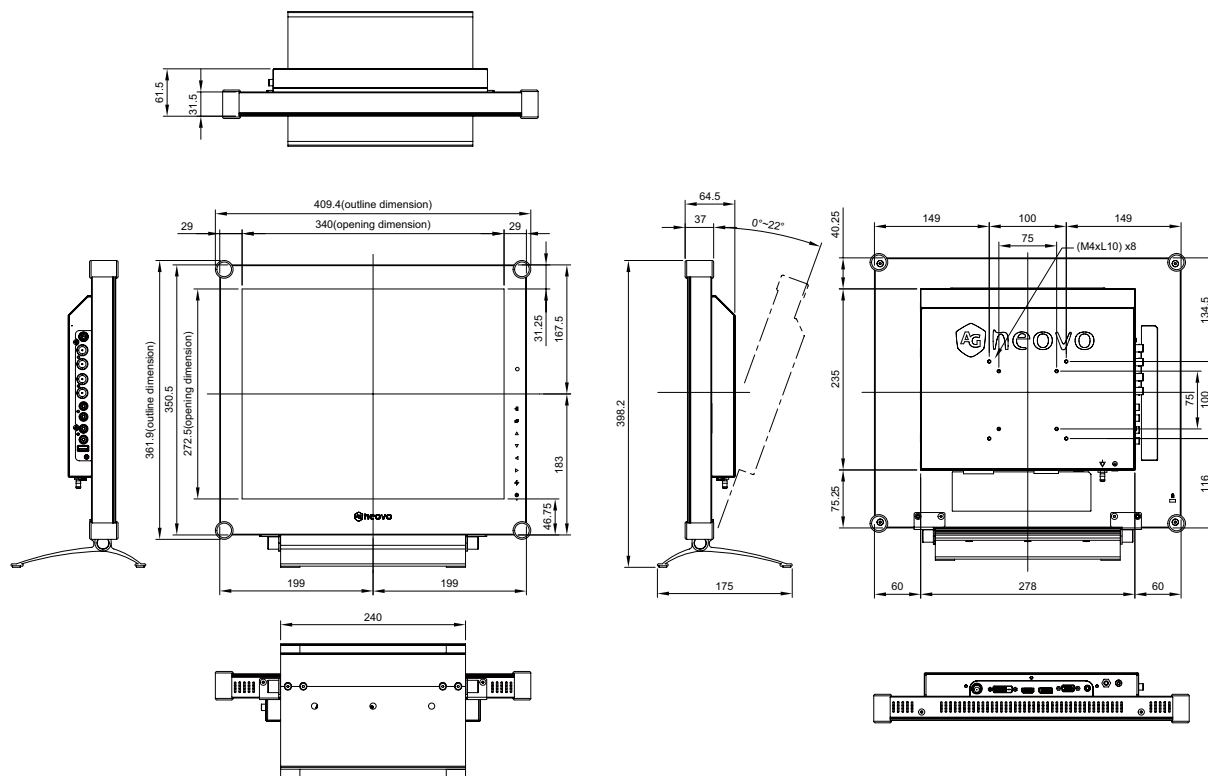

### 7.2.2 DR-22E Dimensions

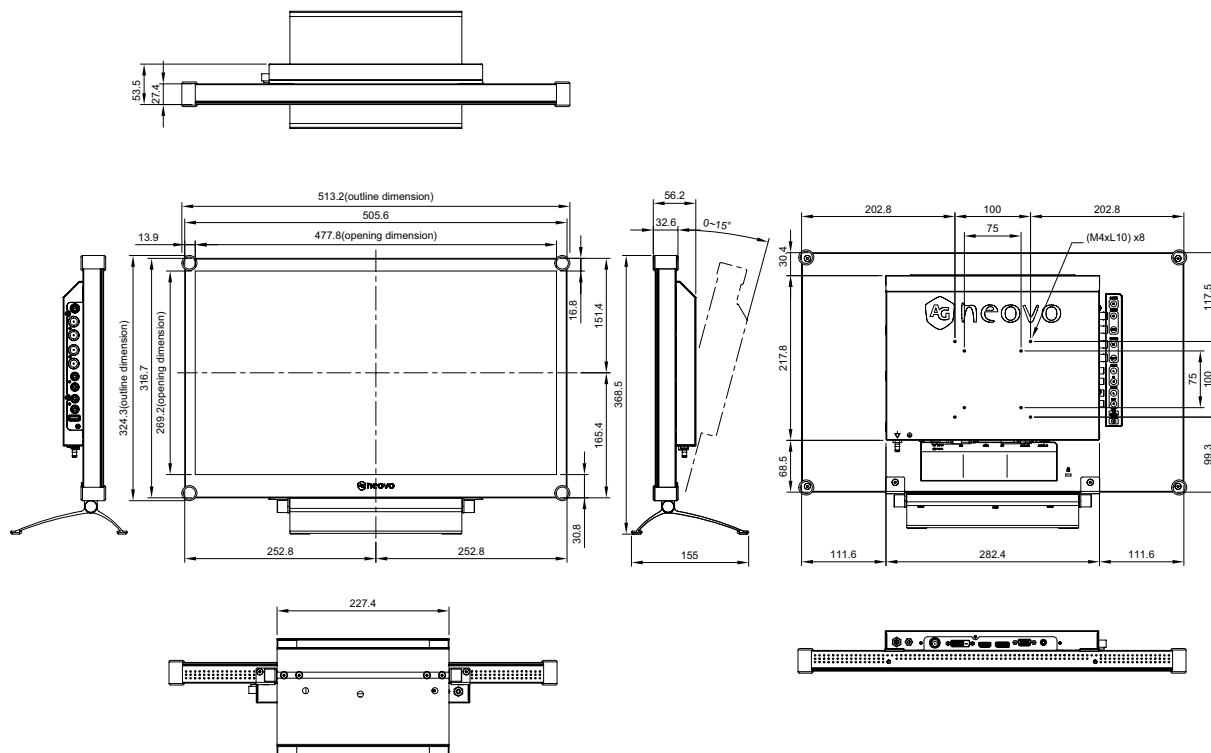

## AG Neovo

Company Address: 5F-1, No. 3-1, Park Street, Nangang District, Taipei, 11503, Taiwan.

Copyright © 2018 AG Neovo. All rights reserved.

DR2E00/DR7E00\_UM\_V011