



THE DISPLAY CHOICE
OF PROFESSIONALS™

NSD-3203, NSD-4303, NSD-5503 & NSD-6503 LCD Display

www.agneovo.com

User Manual

TABLE OF CONTENTS

SAFETY INFORMATION	1
Federal Communications Commission (FCC) Notice (U.S. Only).....	1
Polish Center for Testing and Certification Notice	1
Electric, Magnetic and Electromagnetic Fields ("EMF").....	2
Information for U.K. only.....	3
North Europe (Nordic Countries) Information.....	4
End-of-Life Disposal	5
Waste Electrical and Electronic Equipment-WEEE.....	5
Turkey RoHS.....	6
Ukraine RoHS	6
PRECAUTIONS	7
Cautions When Setting Up	7
Cautions When Using.....	8
Cleaning and Maintenance.....	8
Notice for the LCD Display	9
CHAPTER 1: PRODUCT DESCRIPTION.....	10
1.1 Unpacking	10
1.2 Package Contents	10
1.3 Preparing for the Installation	11
1.4 Wall Mounting Installation.....	11
1.4.1 VESA Grid	12
1.4.2 Mounting the LCD Display on the Wall (WMK-04) (for NSD-5503/NSD-6503 Only)	13
1.4.3 Ventilation Requirements for Enclosure Locating	17
1.5 LCD Display Overview	18
1.5.1 Front View	18
1.5.2 Input/Output Terminals	19
1.6 Remote Control	20
1.6.1 General Functions	20
1.6.2 Inserting the Batteries in the Remote Control	21
1.6.3 Handling the Remote Control	21
1.6.4 Operating Range of the Remote Control.....	22
CHAPTER 2: MAKING CONNECTIONS.....	23
2.1 Connecting the Power	23
2.2 Connecting a Computer or Portable Device.....	24
2.2.1 Using HDMI Input	24
2.2.2 Using RS232 Input	24
2.3 Connecting External Equipment (Video Player)	25
2.4 Connecting Audio Equipment.....	26
2.5 Connecting to a Wired Network.....	27
2.6 Connecting USB Interface Devices	28

TABLE OF CONTENTS

CHAPTER 3: USING THE LCD DISPLAY	29
3.1 Turning on the Power	29
3.1.1 Initial Setup.....	29
3.2 Selecting the Input Source Signal	30
3.3 Adjusting the Volume.....	30
3.4 Using the On-Screen Keyboard	30
CHAPTER 4: MULTIMEDIA MENU	31
4.1 Accessing the Multimedia Menu.....	31
4.2 Primary CMS	31
4.3 USB Signage.....	33
4.3.1 Selecting the Play Mode.....	33
4.4 Browser	37
4.4.1 Adding and Managing URLs.....	37
4.5 Screen Sharing.....	39
4.6 Apps Manager	41
4.6.1 Installing Apps	41
4.6.2 Uninstalling Apps.....	42
CHAPTER 5: ADJUSTING THE SETTINGS	43
5.1 Settings Menu	43
5.1.1 Settings Menu Tree	44
5.2 Configuring the Settings.....	46
5.2.1 Picture Menu	46
5.2.2 Screen Display Menu	47
5.2.3 Sound Menu	51
5.2.4 Network Menu	53
5.2.5 System Menu	56
CHAPTER 6: APPENDIX	64
6.1 Warning Messages.....	64
6.2 Supported Media Formats.....	64
6.3 Supported Timings	67
6.4 Troubleshooting.....	70
6.5 Transporting the LCD Display	71
CHAPTER 7: SPECIFICATIONS	72
7.1 Display Specifications	72
7.2 Display Dimensions.....	73

SAFETY INFORMATION

Federal Communications Commission (FCC) Notice (U.S. Only)



This equipment has been tested and found to comply with the limits for a Class B digital device, pursuant to part 15 of the FCC Rules. These limits are designed to provide reasonable protection against harmful interference in a residential installation. This equipment generates, uses and can radiate radio frequency energy and, if not installed and used in accordance with the instructions, may cause harmful interference to radio communications. However, there is no guarantee that interference will not occur in a particular installation. If this equipment does cause harmful interference to radio or television reception, which can be determined by turning the equipment off and on, the user is encouraged to try to correct the interference by one or more of the following measures:

- Reorient or relocate the receiving antenna.
- Increase the separation between the equipment and receiver.
- Connect the equipment into an outlet on a circuit different from that to which the receiver is connected.
- Consult the dealer or an experienced radio/TV technician for help.



Changes or modifications not expressly approved by the party responsible for compliance could void the user's authority to operate the equipment.

Use only an RF shielded cable that was supplied with the display when connecting this display to a computer device.

To prevent damage which may result in fire or shock hazard, do not expose this appliance to rain or excessive moisture.

THIS CLASS B DIGITAL APPARATUS MEETS ALL REQUIREMENTS OF THE CANADIAN INTERFERENCE-CAUSING EQUIPMENT REGULATIONS.



This device complies with Part 15 of the FCC Rules. Operation is subject to the following two conditions: (1) this device may not cause harmful interference, and (2) this device must accept any interference received, including interference that may cause undesired operation.

Polish Center for Testing and Certification Notice

The equipment should draw power from a socket with an attached protection circuit (a three-prong socket). All equipment that works together (computer, display, printer, and so on) should have the same power supply source.

The phasing conductor of the room's electrical installation should have a reserve short-circuit protection device in the form of a fuse with a nominal value no larger than 16 amperes (A).

To completely switch off the equipment, the power supply cable must be removed from the power supply socket, which should be located near the equipment and easily accessible.

A protection mark "B" confirms that the equipment is in compliance with the protection usage requirements of standards PN-93/T-42107 and PN-89/E-06251.

SAFETY INFORMATION

Wymagania Polskiego Centrum Badań i Certyfikacji

Urządzenie powinno być zasilane z gniazda z przyłączonym obwodem ochronnym (gniazdo z kołkiem). Współpracujące ze sobą urządzenia (komputer, monitor, drukarka) powinny być zasilane z tego samego źródła.

Instalacja elektryczna pomieszczenia powinna zawierać w przewodzie fazowym rezerwową ochronę przed zwarciami, w postaci bezpiecznika o wartości znamionowej nie większej niż 16A (amperów).

W celu całkowitego wyłączenia urządzenia z sieci zasilania, należy wyjąć wtyczkę kabla zasilającego z gniazdka, które powinno znajdować się w pobliżu urządzenia i być łatwo dostępne.

Znak bezpieczeństwa "B" potwierdza zgodność urządzenia z wymaganiami bezpieczeństwa użytkowania zawartymi w PN-93/T-42107 i PN-89/E-06251.

Pozostałe instrukcje bezpieczeństwa

- Nie należy używać wtyczek adapterowych lub usuwać kołka obwodu ochronnego z wtyczki. Jeżeli konieczne jest użycie przedłużacza to należy użyć przedłużacza 3-żyłowego z prawidłowo połączonym przewodem ochronnym.
- System komputerowy należy zabezpieczyć przed nagłymi, chwilowymi wzrostami lub spadkami napięcia, używając eliminatora przepięć, urządzenia dopasowującego lub bezzakłócenieniowego źródła zasilania.
- Należy upewnić się, aby nic nie leżało na kablach systemu komputerowego, oraz aby kable nie były umieszczone w miejscu, gdzie można byłoby na nie nadeptywać lub potykać się o nie.
- Nie należy rozlewać napojów ani innych płynów na system komputerowy.
- Nie należy wpychać żadnych przedmiotów do otworów systemu komputerowego, gdyż może to spowodować pożar lub porażenie prądem, poprzez zwarcie elementów wewnętrznych.
- System komputerowy powinien znajdować się z dala od grzejników i źródeł ciepła. Ponadto, nie należy blokować otworów wentylacyjnych. Należy unikać kładzenia luźnych papierów pod komputer oraz umieszczania komputera w ciasnym miejscu bez możliwości cyrkulacji powietrza wokół niego.

Electric, Magnetic and Electromagnetic Fields ("EMF")

- We manufacture and sell many products targeted at consumers, which, like any electronic apparatus, in general have the ability to emit and receive electromagnetic signals.
- One of our leading Business Principles is to take all necessary health and safety measures for our products, to comply with all applicable legal requirements and to stay well within the EMF standards applicable at the time of producing the products.
- We are committed to develop, produce and market products that cause no adverse health effects.
- We confirm that if its products are handled properly for their intended use, they are safe to use according to scientific evidence available today.
- We play an active role in the development of international EMF and safety standards, enabling us to anticipate further developments in standardization for early integration in its products.

SAFETY INFORMATION

Information for U.K. only

WARNING - THIS APPLIANCE MUST BE EARTHED.

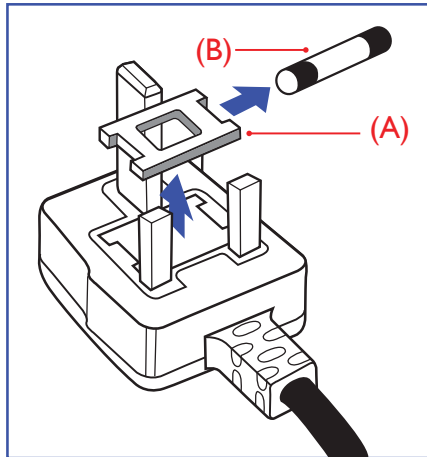

Important:

This apparatus is supplied with an approved moulded 13A plug. To change a fuse in this type of plug proceed as follows:

- 1 Remove fuse cover and fuse.
- 2 Fit new fuse which should be a BS 1362 5A, A.S.T.A. or BSI approved type.
- 3 Refit the fuse cover.

If the fitted plug is not suitable for your socket outlets, it should be cut off and an appropriate 3-pin plug fitted in its place.

If the mains plug contains a fuse, this should have a value of 5A. If a plug without a fuse is used, the fuse at the distribution board should not be greater than 5A.



Note:

The severed plug must be destroyed to avoid a possible shock hazard should it be inserted into a 13A socket elsewhere.

SAFETY INFORMATION

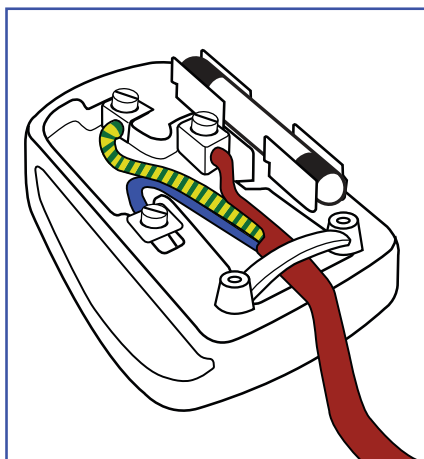

How to connect a plug

The wires in the mains lead are coloured in accordance with the following code:

BLUE - "NEUTRAL" ("N")

BROWN - "LIVE" ("L")

GREEN & YELLOW - "EARTH" ("E")

- The GREEN & YELLOW wire must be connected to the terminal in the plug which is marked with the letter "E" or by the Earth symbol or coloured GREEN or GREEN & YELLOW.
- The BLUE wire must be connected to the terminal which is marked with the letter "N" or coloured BLACK.
- The BROWN wire must be connected to the terminal which marked with the letter "L" or coloured RED.

Before replacing the plug cover, make certain that the cord grip is clamped over the sheath of the lead - not simply over the three wires.

North Europe (Nordic Countries) Information

Placering/Ventilation

VARNING: FÖRSÄKRA DIG OM ATT HUVUDBRYTARE OCH UTTAG ÄR LÄTÅTKOMLIGA, NÄR DU STÄLLER DIN UTRUSTNING PÅPLATS.

Placering/Ventilation

ADVARSEL: SØRG VED PLACERINGEN FOR, AT NETLEDNINGENS STIK OG STIKKONTAKT ER NEMT TILGÆNGLIGE.

Paikka/Ilmankierto

VAROITUS: SIJOITA LAITE SITEN, ETTÄ VERKKOJOHTO VOIDAAN TARVITTAESSA HELPOSTI IRROTTAA PISTORASIESTA.

Plassering/Ventilasjon

ADVARSEL: NÅR DETTE UTSTYRET PLASSERES, MÅ DU PASSE PÅ AT KONTAKTENE FOR STØMTILFØRSEL ER LETTE Å NÅ.

SAFETY INFORMATION

End-of-Life Disposal

Your new Public Information Display contains materials that can be recycled and reused. Specialized companies can recycle your product to increase the amount of reusable materials and to minimize the amount to be disposed of.

Please find out about the local regulations on how to dispose of your old display from your local dealer.

(For customers in Canada and U.S.A.)

This product may contain lead and/or mercury. Dispose of in accordance to local-state and federal regulations. For additional information on recycling contact www.eia.org (Consumer Education Initiative).

Waste Electrical and Electronic Equipment-WEEE

Attention users in European Union private households



This marking on the product or on its packaging illustrates that, under European Directive 2012/19/EU governing used electrical and electronic appliances, this product may not be disposed of with normal household waste. You are responsible for disposal of this equipment through a designated waste electrical and electronic equipment collection. To determine the locations for dropping off such waste electrical and electronic, contact your local government office, the waste disposal organization that serves your household or the store at which you purchased the product.

- The crossed-out dustbin on the device or outer packaging indicates the product is compliant with European WEEE (Waste Electrical and Electronic Equipment) Directive
- Always dispose of the old devices separately from household waste
- Batteries should be removed beforehand and disposed separately to the right collection system
- You are responsible with regard to the deletion of personal data on old devices before disposal
- Private households can hand in their old devices free of charge
- For more information about where you can drop off your waste equipment for recycling, please contact your local city office, your household waste disposal service or the shop where you purchased the product

Attention users in United States:

Please dispose of according to all Local, State and Federal Laws. For the disposal or recycling information, contact: www.mygreenelectronics.com or www.eiae.org.

End of Life Directives-Recycling



Your new Public Information Display contains several materials that can be recycled for new users.

Please dispose of according to all Local, State, and Federal laws.

SAFETY INFORMATION

Restriction on Hazardous Substances statement (India)

This product complies with the “India E-waste Rule 2011” and prohibits use of lead, mercury, hexavalent chromium, polybrominated biphenyls or polybrominated diphenyl ethers in concentrations exceeding 0.1 weight % and 0.01 weight % for cadmium, except for the exemptions set in Schedule 2 of the Rule.

E-Waste Declaration for India



This symbol on the product or on its packaging indicates that this product must not be disposed of with your other household waste. Instead it is your responsibility to dispose of your waste equipment by handing it over to a designated collection point for the recycling of waste electrical and electronic equipment. The separate collection and recycling of your waste equipment at the time of disposal will help to conserve natural resources and ensure that it is recycled in a manner that protects human health and the environment.

Batteries



For EU: The crossed-out wheeled bin implies that used batteries should not be put to the general household waste! There is a separate collection system for used batteries, to allow proper treatment and recycling in accordance with legislation.

Please contact your local authority for details on the collection and recycling schemes.

For Switzerland: The used battery is to be returned to the selling point.

For other non-EU countries: Please contact your local authority for correct method of disposal of the used battery.

According to EU directive 2006/66/EC, the battery can't be disposed improperly. The battery shall be separated to collect by local service.

Turkey RoHS

Türkiye Cumhuriyeti: EEE Yönetmeliğine Uygundur.

Ukraine RoHS

Обладнання відповідає вимогам Технічного регламенту щодо обмеження використання деяких небезпечних речовин в електричному та електронному обладнанні, затвердженого постановою Кабінету Міністрів України від 3 грудня 2008 № 1057.

PRECAUTIONS

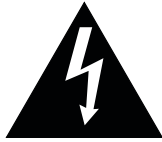

Symbols used in this manual

	This icon indicates the existence of a potential hazard that could result in personal injury or damage to the product.
	This icon indicates important operating and servicing information.

Notice

- Read this User Manual carefully before using the LCD display and keep it for future reference.
- The product specifications and other information provided in this User Manual are for reference only. All information is subject to change without notice. Updated content can be downloaded from our web site at www.agneovo.com.
- To protect your rights as a consumer, do not remove any stickers from the LCD display. Doing so may affect the determination of the warranty period.

Cautions When Setting Up

- Do not place the LCD display near heat sources, such as a heater, exhaust vent, or in direct sunlight.
- Do not cover or block the ventilation holes in the housing.
- Place the LCD display on a stable area. Do not place the LCD display where it may be subject to vibration or shock.
- Place the LCD display in a well-ventilated area.
- Do not place the LCD display outdoors.
- To avoid the risk of shock or permanent damage to the set, do not expose the display to dust, rain, water or an excessively moist environment.
- Do not spill liquid or insert sharp objects into the LCD display through the ventilation holes. Doing so may cause accidental fire, electric shock or damage the LCD display.

PRECAUTIONS

Cautions When Using

- Use only the power cord supplied with the LCD display.
- The power outlet should be installed near the LCD display and be easily accessible.
- If an extension cord is used with the LCD display, ensure that the total current consumption plugged into the power outlet does not exceed the ampere rating.
- Do not allow anything to rest on the power cord. Do not place the LCD display where the power cord may be stepped on.
- If the LCD display will not be used for an indefinite period of time, unplug the power cord from the power outlet.
- To disconnect the power cord, grasp and pull by the plug head. Do not tug on the cord; doing so may cause fire or electric shock.
- Do not unplug or touch the power cord with wet hands.
- When turning off the display by detaching the power cord, wait 6 seconds before re-attaching the power cord for normal operation.
- Do not knock or drop the display during operation or transportation.

Cleaning and Maintenance

- To protect your display from possible damage, do not put excessive pressure on the LCD display. When moving your display, grasp the frame to lift; do not lift the display by placing your hand or fingers on the LCD display.
- If your display becomes wet, wipe it with dry cloth as soon as possible.
- If a foreign substance or water gets in your display, turn the power off immediately and disconnect the power cord. Then remove the foreign substance or water, and send the unit to the maintenance center.
- In order to maintain the best performance of your display and ensure a longer lifetime, we strongly recommend using the display in a location that falls within the following temperature and humidity ranges.
 - ◆ Temperature: 0°C-40°C (32°F-104°F)
 - ◆ Humidity: 20%-80% (non-condensing)



Warning:



Unplug the power cord from the power outlet and refer to qualified service

personnel under the following conditions:

- ◆ When the power cord is damaged.
- ◆ If the LCD display has been dropped or the housing has been damaged.
- ◆ If the LCD display emits smoke or a distinct odor.

PRECAUTIONS

Notice for the LCD Display

- In order to maintain the stable luminous performance, it is recommended to use low brightness setting.
- Due to the lifespan of the lamp, it is normal that the brightness quality of the LCD display may decrease with time.
- When static images are displayed for long periods of time, the image may cause an imprint on the LCD display. This is called image retention or burn-in.
 - ◆ To prevent image retention, do any of the following:
 - Set the LCD display to turn off after a few minutes of being idle.
 - Use a screen saver that has moving graphics or a blank white image.
 - Switch desktop backgrounds regularly.
 - Adjust the LCD display to low brightness settings.
 - Turn off the LCD display when the system is not in use.
 - ◆ Things to do when the LCD display shows image retention:
 - Turn off the LCD display for extended periods of time. It can be several hours or several days.
 - Use a screen saver and run it for extended periods of time.
 - Use a black and white image and run it for extended periods of time.
- There are millions of micro transistors inside the LCD display. It is normal for a few transistors to be damaged and to produce spots. This is acceptable and is not considered a failure.
- **IMPORTANT:** Always activate a moving screen saver program when you leave your display unattended. Always activate a periodic screen refresh application if the unit will display unchanging static content. Uninterrupted display of still or static images over an extended period may cause “burn in”, also known as “after-imaging” or “ghost imaging”, on your screen. This is a well-known phenomenon in LCD display technology. In most cases, the “burned in” or “after-imaging” or “ghost imaging” will disappear gradually over a period of time after the power has been switched off.
- **WARNING:** Severe “burn-in” or “after-image” or “ghost image” symptoms will not disappear and cannot be repaired. This is also not covered under the terms of your warranty.

CHAPTER 1: PRODUCT DESCRIPTION

1.1 Unpacking

- This product is packed in a packaging box which contains standard accessories.
- Any other optional accessories will be packed separately.
- Considering the size and weight of the display, it is recommended that this product is carried out by two persons.
- After opening the packaging box, ensure that the included items are in good condition and complete.

1.2 Package Contents

When unpacking, check if the following items are included in the package. If any of them is missing or damaged, contact your dealer.

LCD Display



Remote Control



Quick Start Guide



HDMI Cable

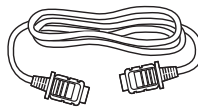

Power Cord

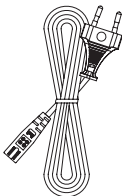

AAA Batteries x2

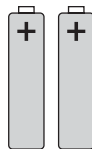

Note:

- ◆ Remote control is shipped with the supplied AAA batteries.
- ◆ For all other regions, apply a power cord that conforms to the AC voltage of the power socket and has been approved by and complies with the safety regulations of the particular country (Type H05W-F, 2G or 3G, 0.75 or 1 mm² should be used).
- ◆ You might like to save the package box and packing material for shipping the display.
- ◆ The pictures are for reference only. Actual items may vary upon shipment.
- ◆ If you need to wall mount the LCD display, please see the following website for more information:
<https://www.agneovo.com/global/product-category/accessories/mounts/wall-mounts>

PRODUCT DESCRIPTION

1.3 Preparing for the Installation

- Due to the high power consumption, always use the plug exclusively designed for this product. If an extended line is required, please consult your service agent.
- The product should be installed on a flat surface to avoid tipping. The distance between the back of the product and the wall should be maintained for proper ventilation. Avoid installing the product in the kitchen, bathroom or any other places with high humidity so as not to shorten the service life of the electronic components.
- The product can normally operate only under 3600m in altitude. In installations at altitudes above 3600m, some abnormalities may be experienced.

1.4 Wall Mounting Installation

To mount this display to a wall, you will have to obtain a standard wall-mounting kit (commercially available). We recommend using a mounting interface that complies with TUV-GS and/or UL1678 standard in North America.

To wall-mount the LCD display, screw the mounting bracket to the VESA holes at the rear of the LCD display.

NSD-3203

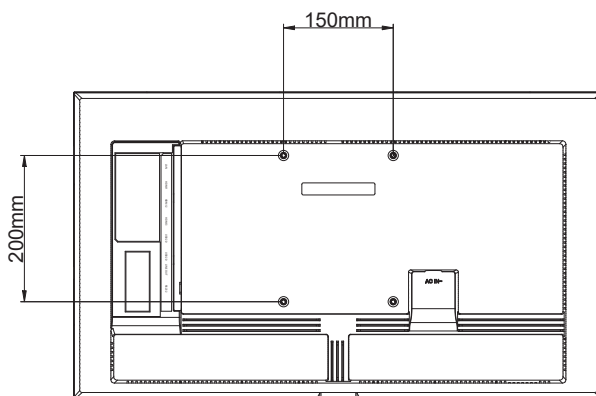

NSD-4303

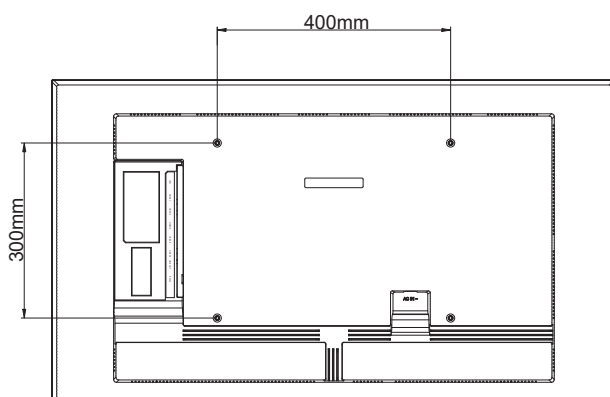

Warning:

- ◆ Do not press too hard on the LCD display or edge of the frame, as this may cause the device to malfunction.

Note:

- ◆ Avoid the wall-mounting kit to block the ventilation holes on the back of the display.
- ◆ Secure the LCD display on a solid wall strong enough to bear its weight.
- ◆ Lay a protective sheet on a table, which was wrapped around the display when it was packaged, beneath the screen surface so as not to scratch the screen face.
- ◆ Ensure you have all accessories for mounting this display (wall mount, ceiling mount, etc).
- ◆ Follow the instructions that come with the base mounting kit. Failure to follow correct mounting procedures could result in damage to the equipment or injury to the user or installer. Product warranty does not cover damage caused by improper installation.

PRODUCT DESCRIPTION

NSD-5503

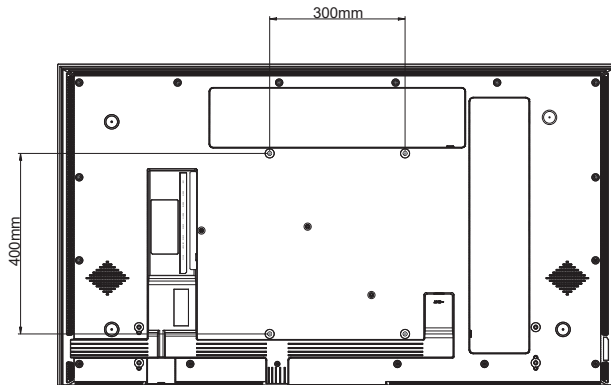

NSD-6503

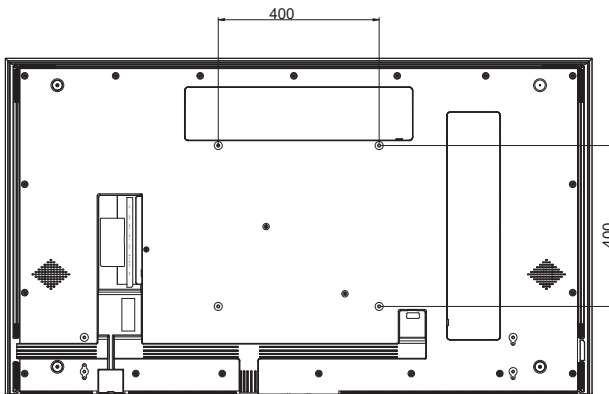

1.4.1 VESA Grid

Model Name	VESA Grid
NSD-3203	150(W) x 200(H)mm
NSD-4303	400(W) x 300(H)mm
NSD-5503	300(W) x 400(H)mm
NSD-6503	400(W) x 400(H)mm

Caution:

To prevent the display from falling:

- ◆ For wall or ceiling installation, we recommend installing the display with metal brackets which are commercially available. For detailed installation instructions, see the guide received with the respective bracket.
- ◆ To lessen the probability of injury and damage resulting from fall of the display in case of earthquake or other natural disaster, be sure to consult the bracket manufacturer for installation location.

Note:

- ◆ For the wall-mounting kit, use M6 mounting screws (having a length 10 mm longer than the thickness of the mounting bracket) and tighten them securely.
- ◆ Unit without base weight:
 NSD-3203=5.4 kg.
 NSD-4303=9.1 kg.
 NSD-5503=17.6 kg.
 NSD-6503=25.3 kg.
 The equipment and its associated mounting means still remain secure during the test.
- ◆ Wall Mount Bracket with minimum weight / load:
 NSD-3203=6.6 kg.
 NSD-4303=11.2 kg.
 NSD-5503=21.6 kg.
 NSD-6503=31.1 kg.

PRODUCT DESCRIPTION

1.4.2 Mounting the LCD Display on the Wall (WMK-04) (For NSD-5503/6503 Only)

To mount the LCD display on the wall, you need the following items:

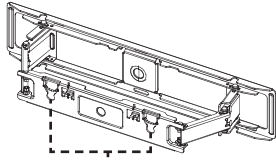

Safety Buckle

Wall Mount x 1



Magnets
x 4



Screws
($\varnothing 3 \times 12$)
x 4



Screws
(M6 x 8)
x 2



Magnetic Pads
x 4



Screw
Expansion
Plugs ($\varnothing 4 \times 30$) x 4



Screws
($\varnothing 5 \times 60$)
x 8



Screw
Expansion
Plugs ($\varnothing 5 \times 60$) x 8



Screws
($\varnothing 4 \times 30$)
x 4

Note:

- ◆ Unit without base weight:
NSD-5503=17.6 kg.
NSD-6503=25.3 kg.
The equipment and its associated mounting means still remain secure during the test.
- ◆ Wall Mount Bracket Maximum load capacity per unit is 30kg.

PRODUCT DESCRIPTION

- 1 Insert four magnets and then secure four screws ($\varnothing 3 \times 12$) into wall mount screw holes.
- 2 Remove the backshell cover.
- 3 Secure two screws (M6 x 8) to the backshell.

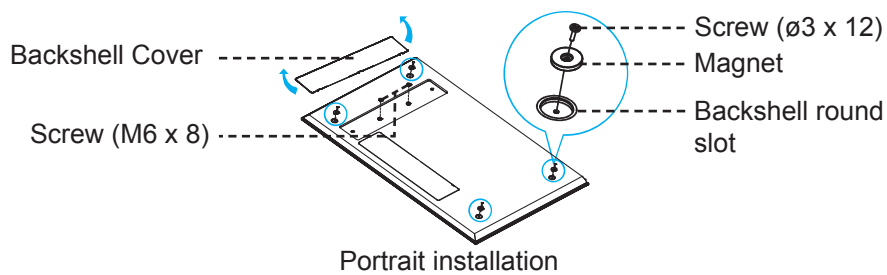
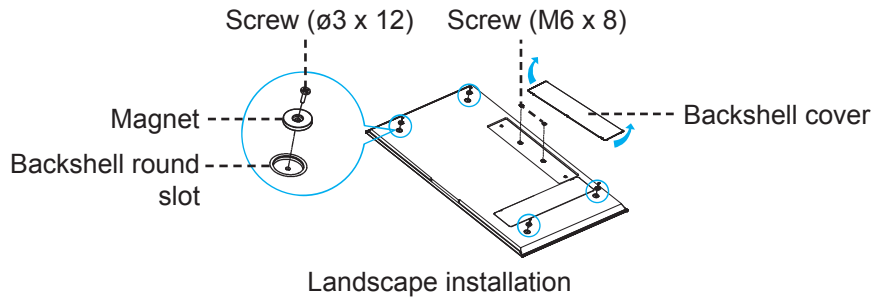

- 4 Position the wall mount and magnets on the wall according to the following dimension diagram.

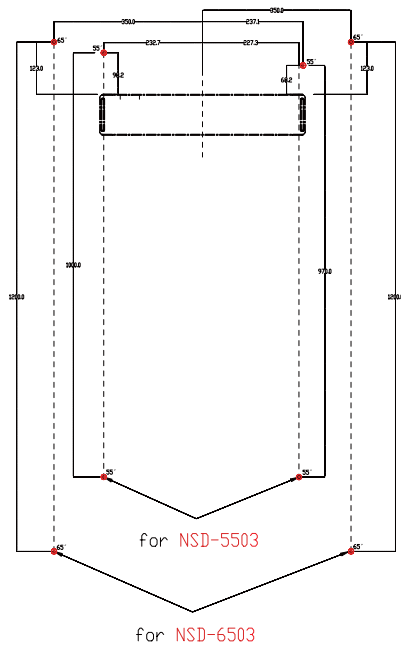

Portrait

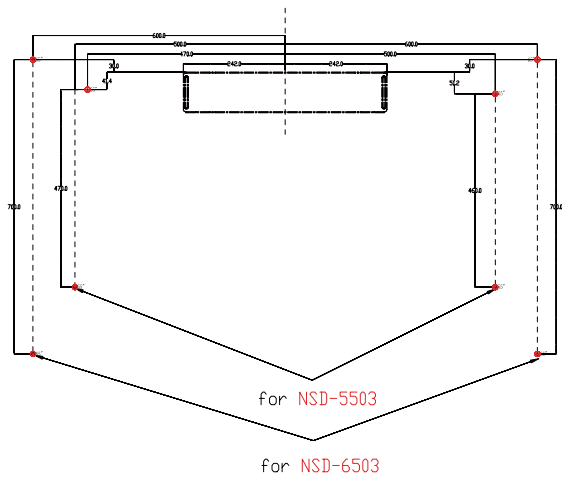

Landscape

PRODUCT DESCRIPTION

- 5 Use a level to mount the wall mount horizontally on the wall with the arrow symbol pointing "UP".
- 6 Insert eight screw expansion plugs into the screw holes on the wall mount bracket.
- 7 Secure the wall mount bracket to the wall with the eight screws (M6 x 8).

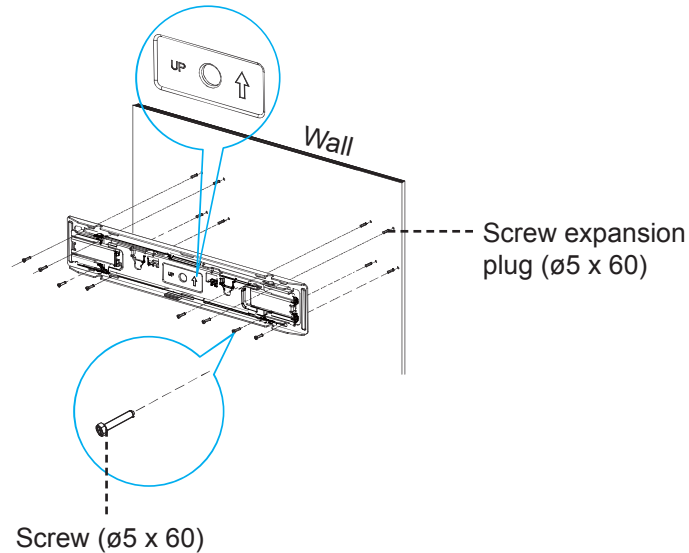

- 8 Extend the wall mount to its maximum stretch and unlock the safety buckle to observe the alignment of the LCD display's wall mount screws and bracket hook slots.
- 9 Insert four screw expansion plugs (ø4 x 30) to the mounting screw holes on the wall.
- 10 Insert four magnetic pads to the mounting screw holes on the wall.
- 11 Secure four screws (ø4 x 30) to the mounting screw holes on the wall.

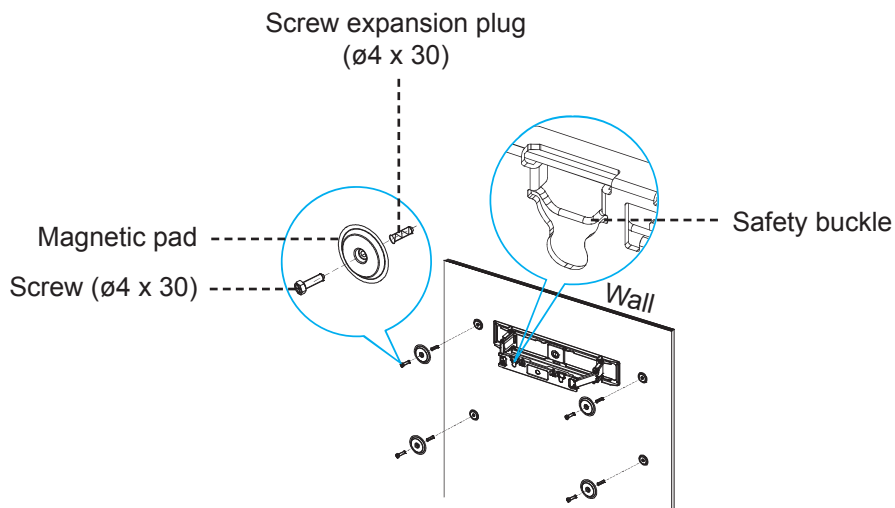

PRODUCT DESCRIPTION

- 12 Align the wall mount bracket with the backshell. Then hang the screws (M6 x 8) into the wall mount recesses. Press the safety buckle back, organize the LCD display cables into the alignment slots.

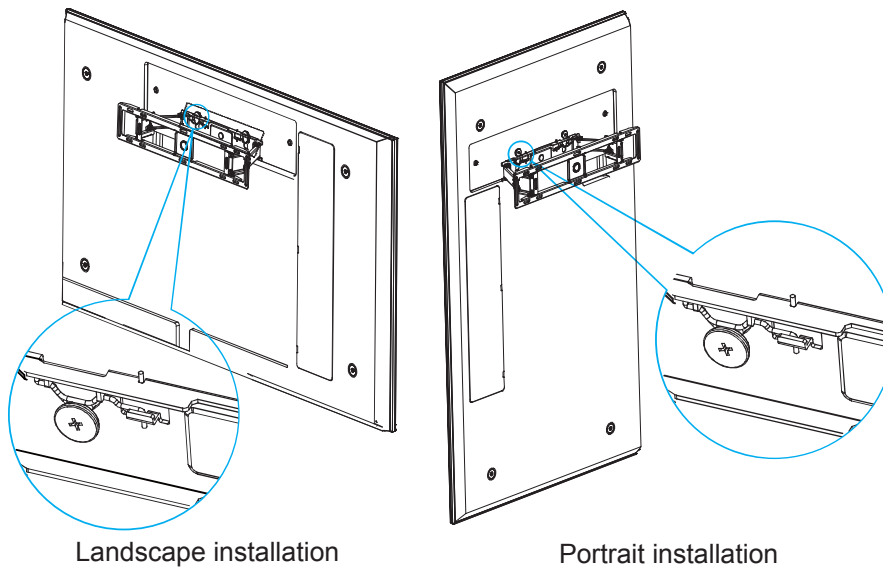

Note:

- ◆ Keep clearances around the LCD display according to the minimum dimensions as illustrated.
- ◆ Never cover the ventilation holes or insert anything into the housing.
- ◆ Do not place the LCD display in a confined space, such as a cabinet or imbedded closet. Place the display on a sturdy, level surface and make sure an appropriate ventilation is provided.



Warning:

Make sure the power cord of the LCD display is disconnected before the installation.

PRODUCT DESCRIPTION

1.4.3 Ventilation Requirements for Enclosure Locating

To allow heat to disperse, leave space between surrounding objects as shown in the diagram below.

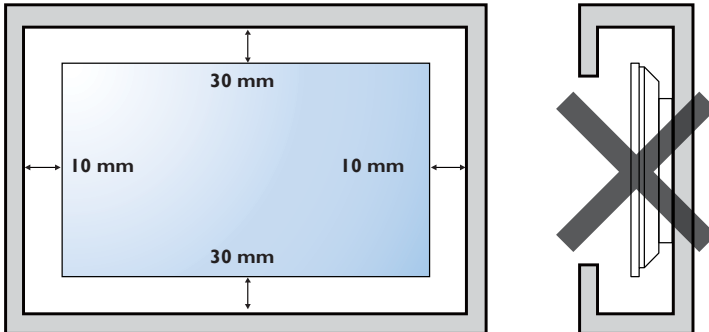

PRODUCT DESCRIPTION

1.5 LCD Display Overview

1.5.1 Front View

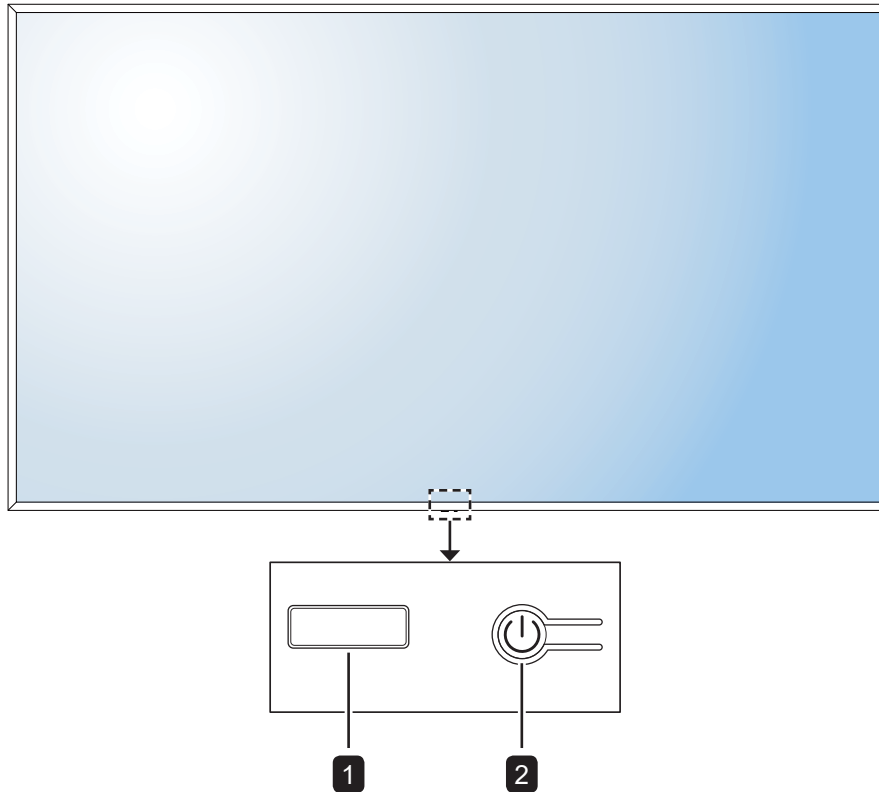

1 LED indicator/IR receiver

- Lights red when the LCD display is in the standby mode. When the LCD display is powered on or in the sleep mode, then the LED is off.
- Receive command signals from the remote control.

Note:

- ◆ In sleep mode, the backlight is off.

2 [⏻] POWER button

Press to turn the LCD display on or off.

PRODUCT DESCRIPTION

1.5.2 Input/Output Terminals

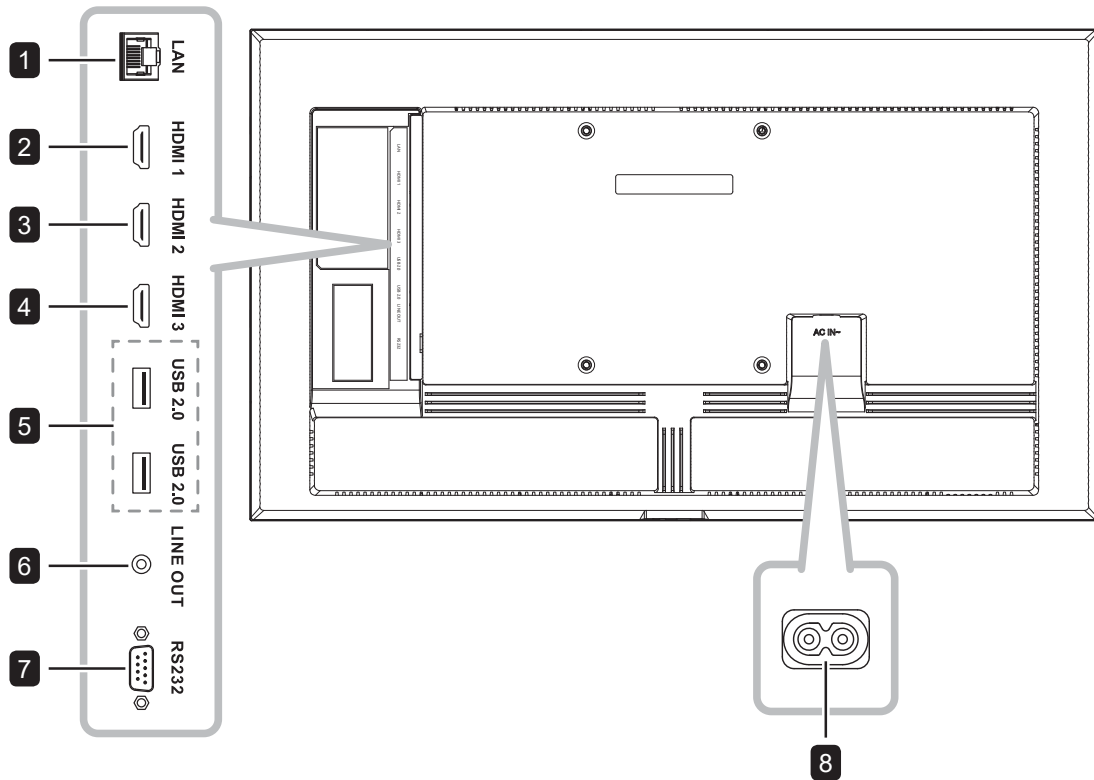

1 LAN

For internet connection with an Ethernet cable.

Note:

- ◆ Supports up to 10/100 Mbps data transmission rates.

2 HDMI 1

Connects HDMI signals input.

3 HDMI 2

Connects HDMI signals input.

4 HDMI 3

Connects HDMI signals input.

5 USB 2.0 (x 2)

Connects to a USB interface device.
(Service Port / Media Playback)

6 LINE OUT

Connects audio signals output
(3.5 mm Stereo Audio Jack).

7 RS232

Connects RS232 input from external equipment.

8 AC power input.

PRODUCT DESCRIPTION

1.6 Remote Control

1.6.1 General Functions

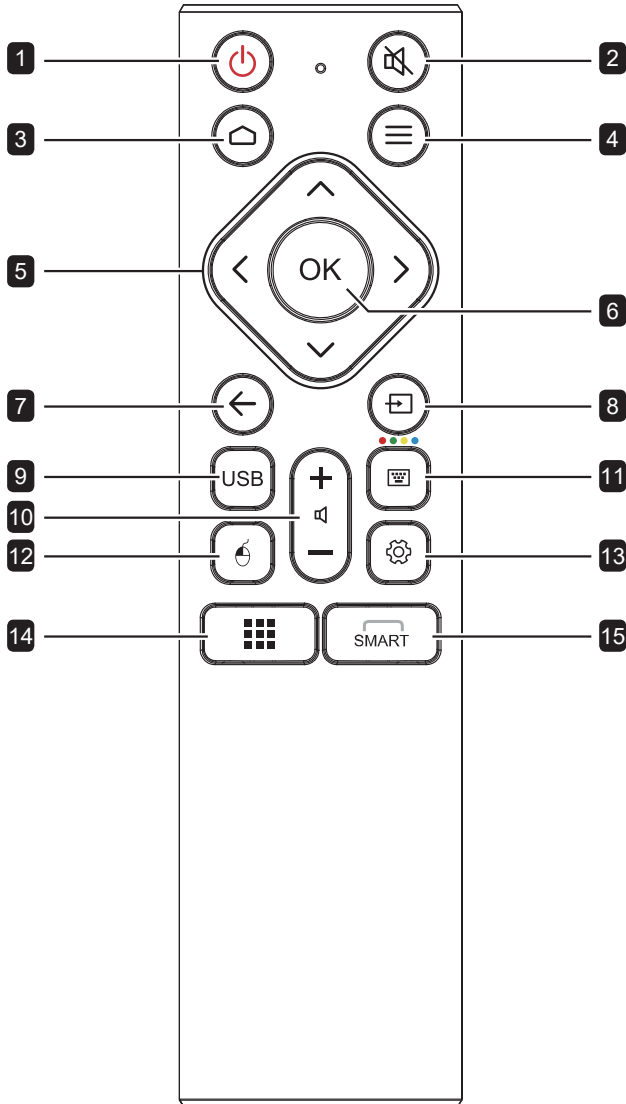

- 1 [Power] Power button:**
Turns the system on or shuts down.
- 2 [Mute] Mute button:**
Turns the mute function on or off.
- 3 [Home] Home button:**
Returns to the Home page.
- 4 [Uninstall app] Uninstall app button:**
Uninstall an app (only Apps source).
- 5 [Navigation] Navigation buttons:**
Navigates through the Settings menu and adjusts the settings.
- 6 [OK] OK button:**
Confirms your selection or saves the modifications.
- 7 [Back] Back button:**
Returns to the previous screen (Android OS) or exits the Settings menu.
- 8 [Source] Source button:**
Opens the source selection menu.
- 9 [USB] USB Signage button:**
Launches the USB Signage screen.
- 10 [Volume] Volume button:**
Adjusts volume. Press [Volume+] to increase volume or press [Volume-] to decrease volume.
- 11 [On-screen keyboard] On-screen keyboard button:**
No function.
- 12 [Mouse control] Mouse control button:**
No function.
- 13 [Settings menu] Settings menu button:**
Opens the Settings menu.
- 14 [Apps] Apps button:**
No function.
- 15 [Smart menu] Smart menu button:**
No function.

PRODUCT DESCRIPTION

1.6.2 Inserting the Batteries in the Remote Control

The remote control is powered by two 1.5V AAA batteries.

To install or replace batteries:

- 1 Slide off the battery compartment cover.
- 2 Align the batteries according to the (+) and (-) indications inside the battery compartment.
- 3 Replace the battery compartment cover.

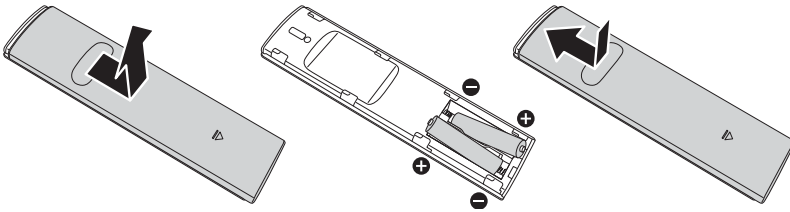

1.6.3 Handling the Remote Control

- Do not subject to strong shock.
- Do not allow water or other liquid to splash the remote control. If the remote control gets wet, wipe it dry immediately.
- Avoid exposure to heat and steam.
- Other than to install the batteries, do not open the remote control.

Caution:

The incorrect use of batteries can result in leaks or bursting. Be sure to follow these instructions:

- ◆ Place “AAA” batteries matching the (+) and (-) signs on each battery to the (+) and (-) signs of the battery compartment.
- ◆ Do not mix battery types.
- ◆ Do not combine new batteries with used ones. It causes shorter life or leakage of batteries.
- ◆ Remove the dead batteries immediately to prevent them from liquid leaking in the battery compartment. Don't touch exposed battery acid, as it can damage your skin.

Note:

- ◆ If you do not intend to use the remote control for a long period, remove the batteries.
- ◆ The remote control may not function properly when the remote control sensor on this display is under direct sunlight or strong illumination, or when there is an obstacle in the path of signal transmission.

PRODUCT DESCRIPTION

1.6.4 Operating Range of the Remote Control

Point the top of the remote control toward the LCD display's remote control sensor (on the left or right side) when pressing a button.

When using the remote control, the distance from the remote control to the sensor on the display should be less than 6m/19ft, and the horizontal and vertical angles should be less than 30°.

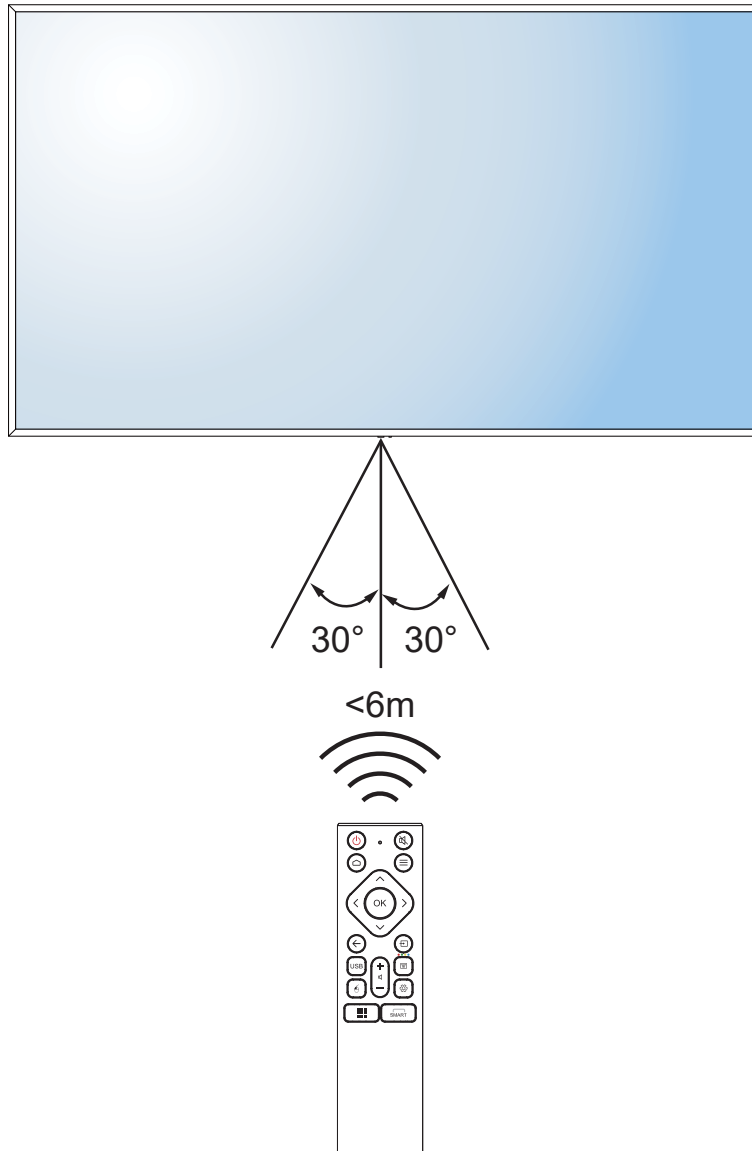

CHAPTER 2: MAKING CONNECTIONS

2.1 Connecting the Power

Note:

- ◆ To operate the LCD display, ensure to use the correct power cord that matches the power outlet in your region.
 - 1 Connect one end of the power cord to the AC IN connector on the LCD display.
 - 2 Connect the other end of the power cord to a power outlet or a power supply.

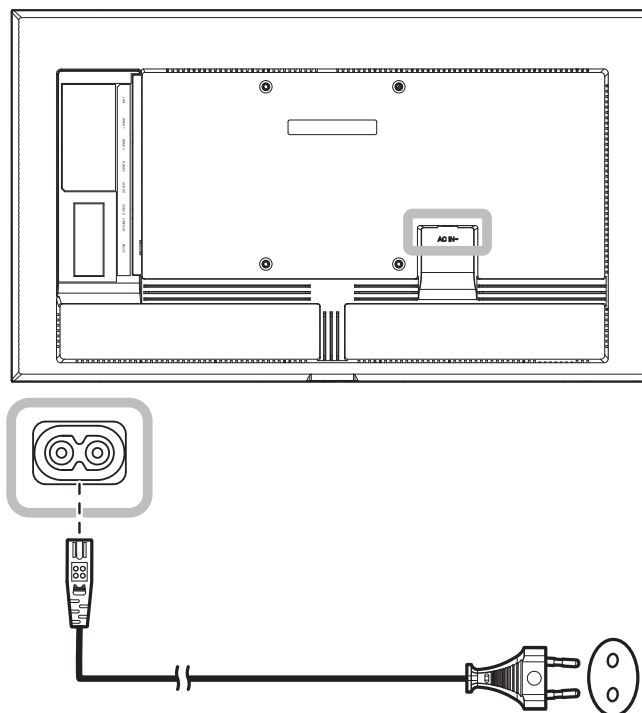

⚡ Caution:

- ◆ Make sure that the LCD display is not connected to the power outlet before making any connections. Connecting cables while the power is ON may cause electric shock or personal injury.
- ◆ When unplugging the power cord, hold the power cord by the plug head. Never pull by the cord.

MAKING CONNECTIONS

2.2 Connecting a Computer or Portable Device

2.2.1 Using HDMI Input

Connect one end of an HDMI cable to the HDMI 1, HDMI 2, or HDMI 3 connector of the LCD display and the other end of an HDMI cable to the HDMI OUT connector of the computer.

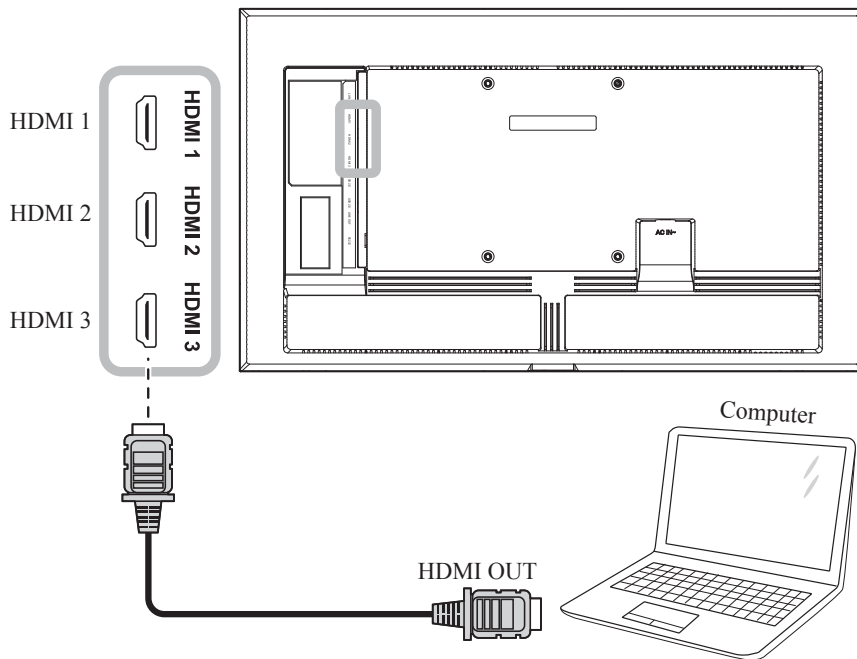

2.2.2 Using RS232 Input

Connect one end of a RS232 serial cable to the RS232 connector of the LCD display and the other end of an RS232 serial cable to the RS232 connector of the computer.

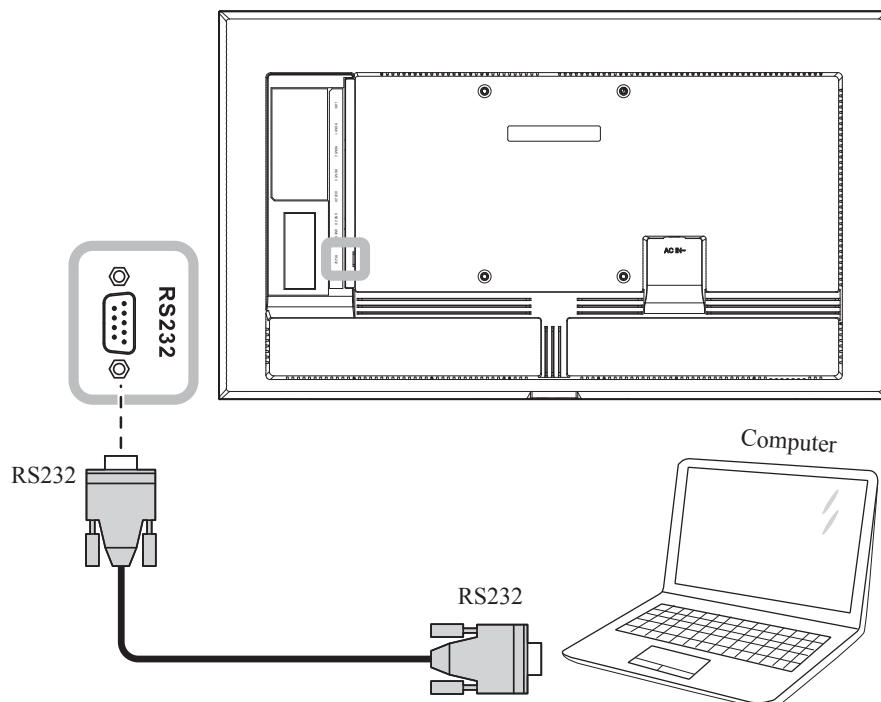

MAKING CONNECTIONS

2.3 Connecting External Equipment (Video Player)

Connect one end of an HDMI cable to the HDMI 1, HDMI 2, or HDMI 3 connector of the LCD display and the other end of an HDMI cable to the HDMI OUT connector of the video player.

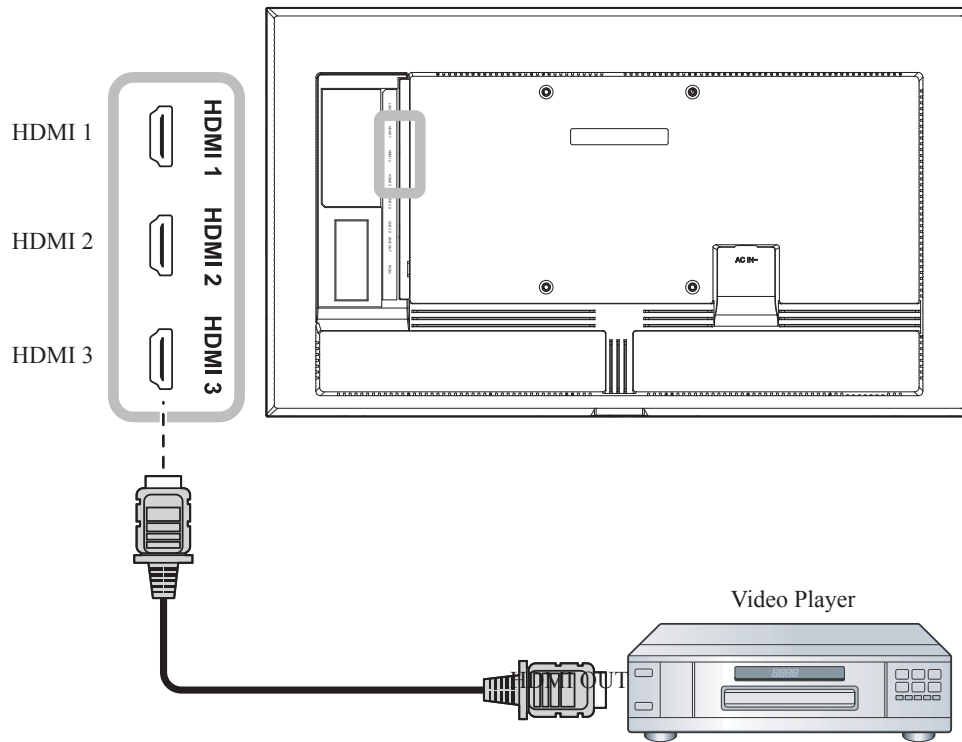

MAKING CONNECTIONS

2.4 Connecting Audio Equipment

Connect one end of an audio cable to the LINE OUT connector of the LCD display and the other end of an audio cable to the AUDIO IN connector of the audio device.

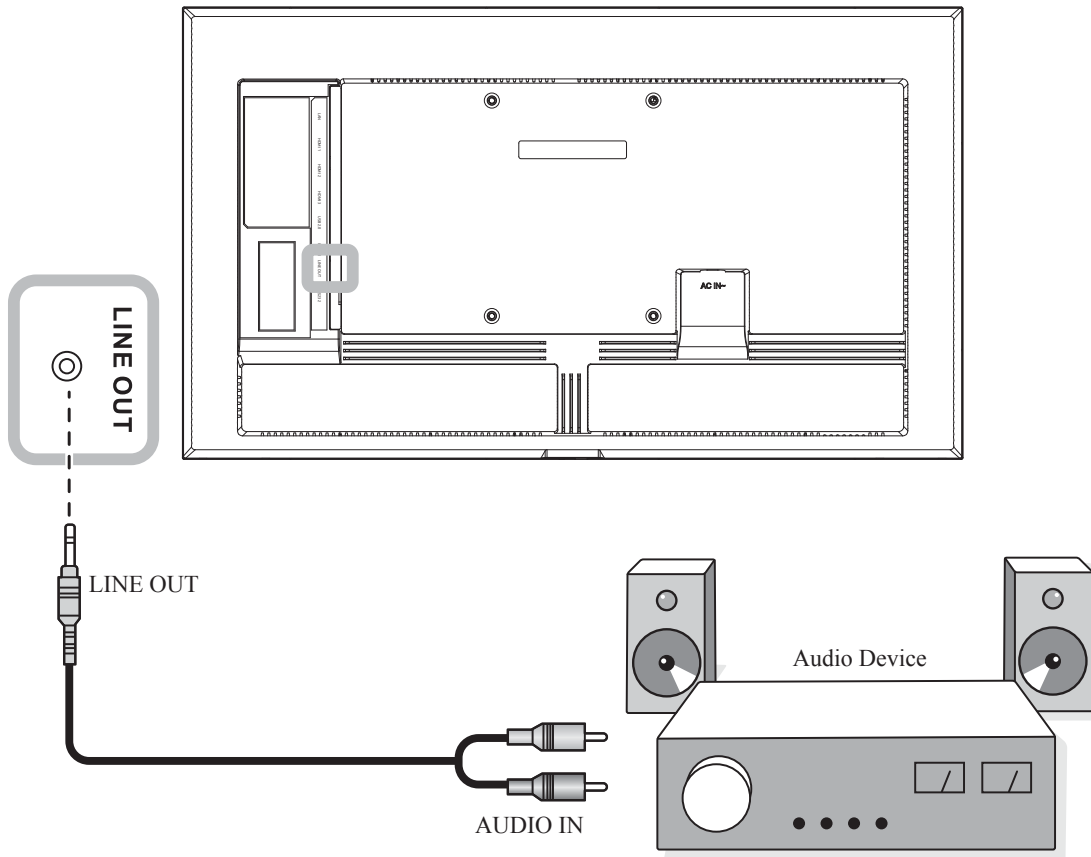

MAKING CONNECTIONS

2.5 Connecting to a Wired Network

Connect one end of a network cable (RJ45) to the LAN connector of the LCD display and the other end of a network cable to a network hub, switch, or router.

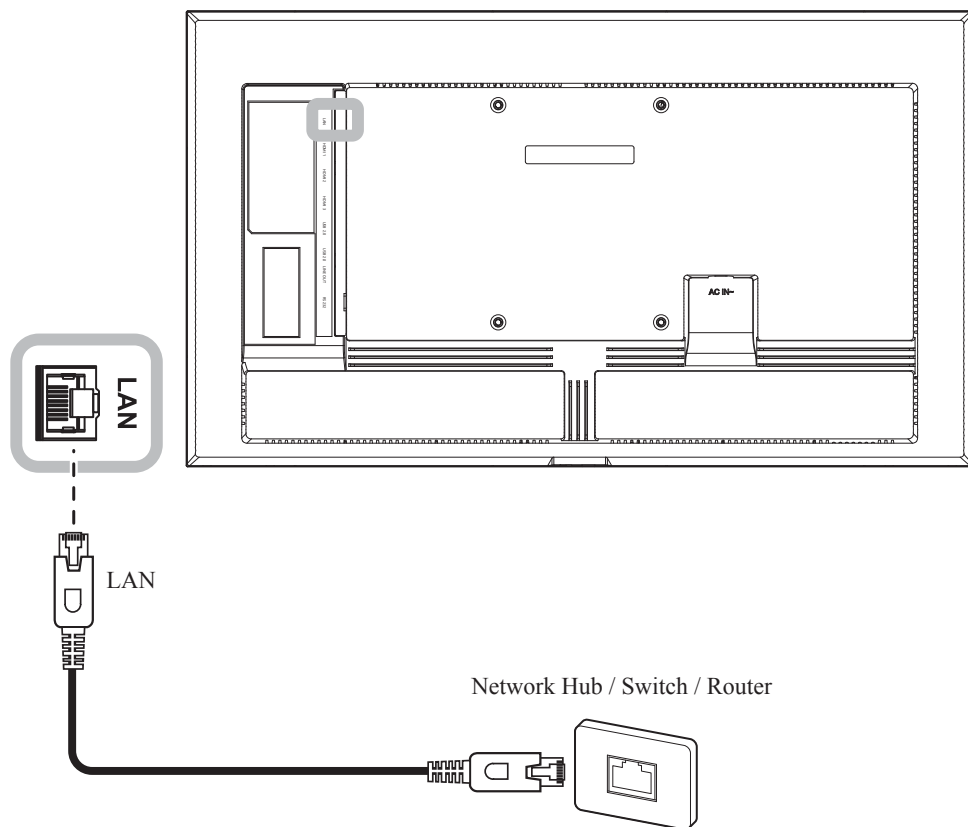

MAKING CONNECTIONS

2.6 Connecting USB Interface Devices

Connect a USB interface device to one of the USB ports of the LCD display for displaying multimedia content or for installing apps.

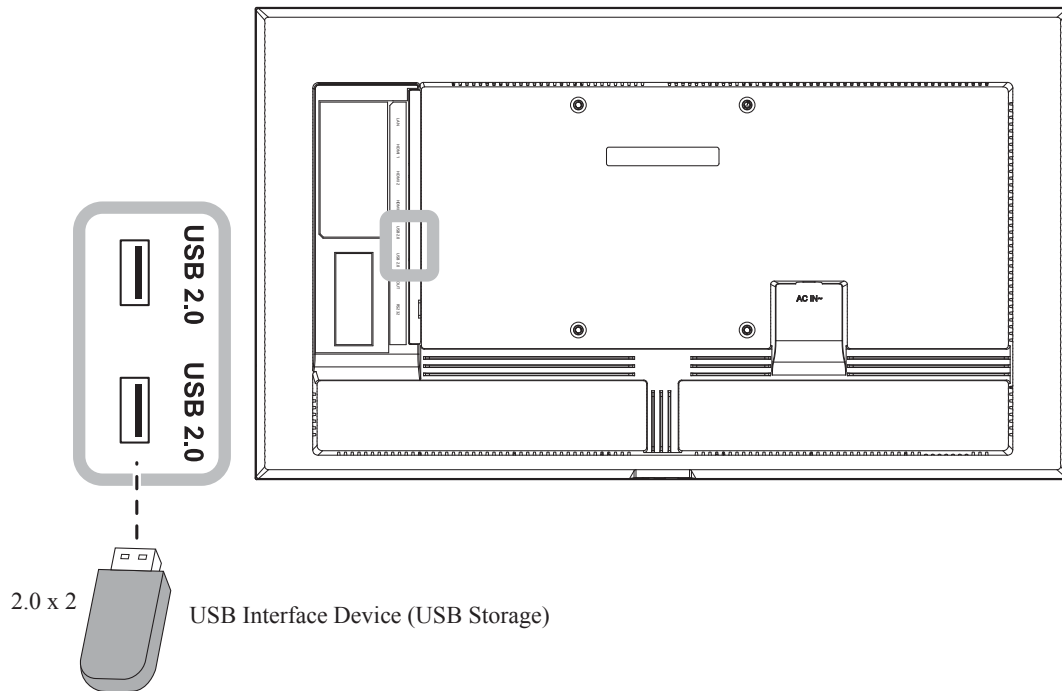

CHAPTER 3: USING THE LCD DISPLAY

3.1 Turning on the Power

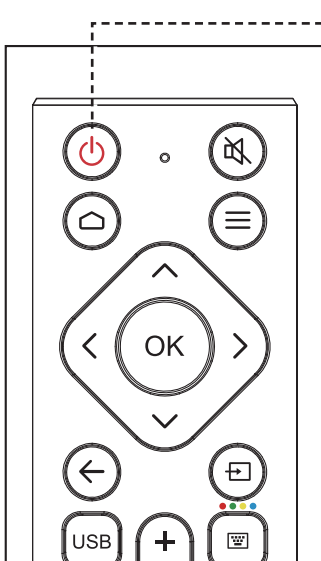

1 Plug the power cord to a power outlet or power supply.

2 Press the  button to turn the LCD display on.

When the LCD display is turned on, press the  button to turn off the LCD display.

Note:

- ◆ The LCD display still consumes power as long as the power cord is connected to the power outlet. Disconnect the power cord to completely cut off power.

3.1.1 Initial Setup

After you turn on the LCD display, a Welcome screen opens. You are prompted to select the default system language, display orientation, configure network settings, and more. Follow the on-screen instructions to complete the initial setup.



Note:

- ◆ The initial setup screen is prompted only the first time you use the LCD display or after resetting the system.

USING THE INTERACTIVE DISPLAY

3.2 Selecting the Input Source Signal

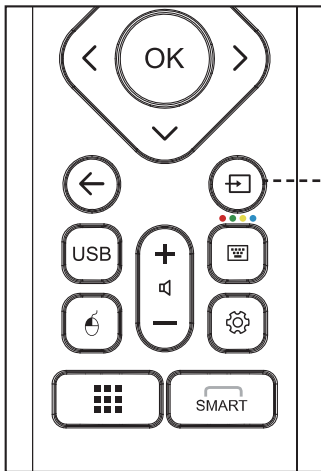

Source button

- 1 Press the button.
- 2 Press the < or > button to select a source, then press the OK button to confirm.

Note:

- ◆ After pressing the button, a menu with available input sources will be displayed on the screen.



Note:

- ◆ After pressing the or button, the volume menu is displayed on the screen automatically.



3.3 Adjusting the Volume

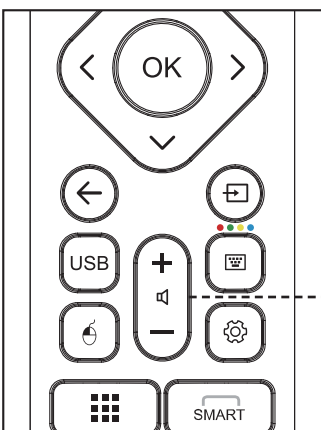

Volume +/- buttons

Press the button to increase the volume or the button to decrease the volume.

- ◆ Press the button to mute the audio. When muted, the icon appears on the bottom right side of the screen.

3.4 Using the On-Screen Keyboard

Whenever you need to input text, an on-screen keyboard opens automatically. Select the keys on the screen as you would press the keys on a connected keyboard.

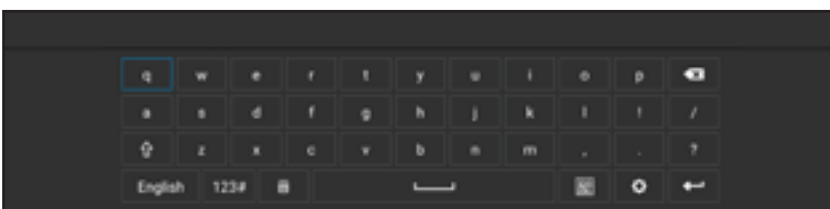

Note:



- ◆ You can also plug in a USB keyboard to input text.

CHAPTER 4: MULTIMEDIA MENU

4.1 Accessing the Multimedia Menu

The multimedia menu consists of five sources, such as Primary CMS, USB Signage, Browser, Screen Sharing, and Apps. To access the multimedia menu items, do the following:



- 1 Press the  button to open a list of input sources.
- 2 Press the  or  button to select **Primary CMS**, **USB Signage**, **Browser**, or **Screen Sharing** from the source list.
- 3 Press the **OK** button on the remote control to open the source.

4.2 Primary CMS

AG Neovo has a partnership with NoviSign and we preload the NoviSign digital signage software on all our NSD Gen 3 series displays as the primary CMS.

The NoviSign app enables you to create and broadcast sophisticated and striking digital channels to engage your customers and to keep them instantly informed. You can choose to use the numerous formatting online tools to easily compose your digital channels, or you can store digital channels that already exist in NoviSign's Digital Signage Software. Your online Studio account (the CMS) includes several templates for easy preparation of these projects. Once you complete your digital projects, you can store them as playlists to be broadcast whenever you wish. In addition, playlists can be grouped together to manipulate multiple projects at once.

To access the Novisign app, press the  button and select the **Primary CMS** as the source. The launcher page will open:



MULTIMEDIA MENU

If you already have Novisign account, then login with your user name and password. If you are using Novisign for the first time, then do the following:

- 1 Open the web browser in your computer and navigate to the <https://www.novisign.com/> website.

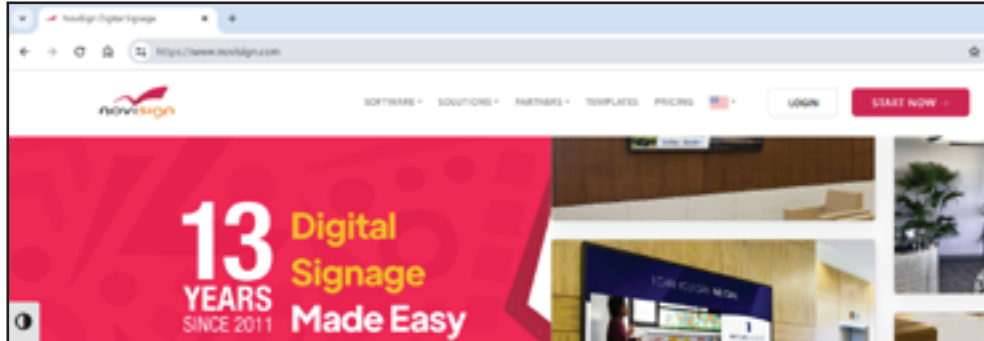

- 2 Click **START NOW**. Then fill out the required fields to sign up.
- 3 After completing the signing up process, you can access the Novisign Studio. Upload your media, add your creatives, create a playlist and player here.
- 4 On the Novisign launcher screen, log in with your Novisign user credentials. Then paste the screen key from the Novisign Studio to the search field and select **Go!**. The media content starts playing on the screen.



Note:

- ◆ Check the “Start player automatically on device startup” checkbox to activate the media player automatically every time the LCD display is turned on.
- ◆ For more information on creating the media content in Novisign Studio, see <https://www.novisign.com/training/digital-signage-guide/>.
- ◆ NoviSign offers 30 days free trial for all users.
- ◆ Change the app of primary CMS to fit your usage. Go to Setting > Screen Display > Primary CMS. For more details, please see page 51.
- ◆ Download and install more AG Neovo’s CMS partner apps from our partner app zone.

MULTIMEDIA MENU

4.3 USB Signage

USB Signage enables to display media content from any available source by plugging in the external USB storage.

To access USB Signage, press the  button and select the **USB Signage** as the source.

The launcher page will open:



To start playing the media content, select the media source:

- USB storage: Copy all the images and videos that you want to display on the screen to the root directory of the USB storage. Then connect the USB storage to the LCD display. The media player will start automatically playing your files in a loop.

Note:

- ◆ If you stop the media player then it will automatically resume after 30 seconds.
- ◆ If the media player does not start automatically after you plug in the USB storage, then ensure that the videos/images saved to the USB storage are set to play at the current time.

4.3.1 Selecting the Play Mode

You can customize when and how your media is played. USB Signage has two modes: Normal and Advanced. In the Normal Mode, settings include layout, timer, and marquee setting to autoplay pictures and videos in carousel. The Advanced Mode includes settings with five scheduled playlists, allowing the alteration of the content for each playback period.

MULTIMEDIA MENU

To choose the play mode, do the following:

select the USB Signage item on the launcher page. The mode selection page will open:

- 1 Select the USB Signage item on the launcher page. The mode selection page will open:



- 2 Select your preferred mode, either **Normal Mode** or **Advanced Mode**.

- 3 Configure the playback settings.

For **Normal Mode**:

— Layout: Select your preferred layout for landscape or portrait mode. Then press **OK** to confirm.



— Timer: Select the play time. Then press **OK** to confirm. "Green blocks" indicate that the time slot is selected and "gray blocks" indicate that the time slot is deselected.

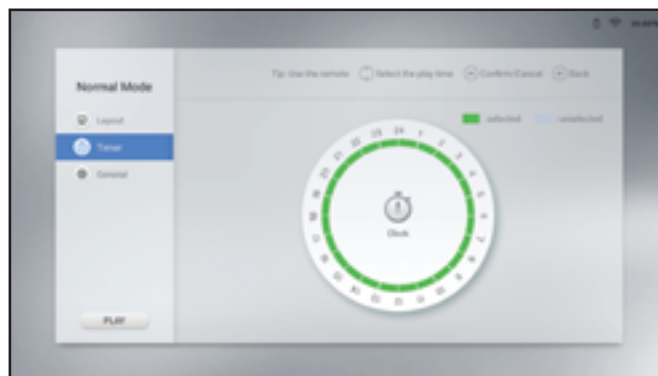

MULTIMEDIA MENU

— General: Select the picture duration and enable or disable the marquee settings. If you enable the marquee settings, then select the speed, orientation, and location for displaying the media content from the USB storage. Then press **OK** to confirm.

Note:

- ◆ Save the marquee settings to the TXT file and name the file as “pmd.txt”. Copy the file to the root directory of the USB storage together with your media files.

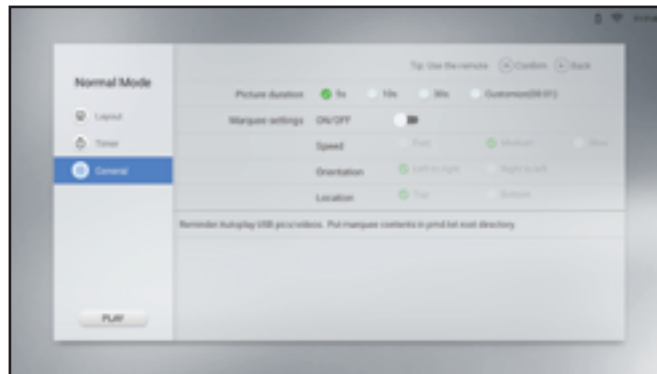

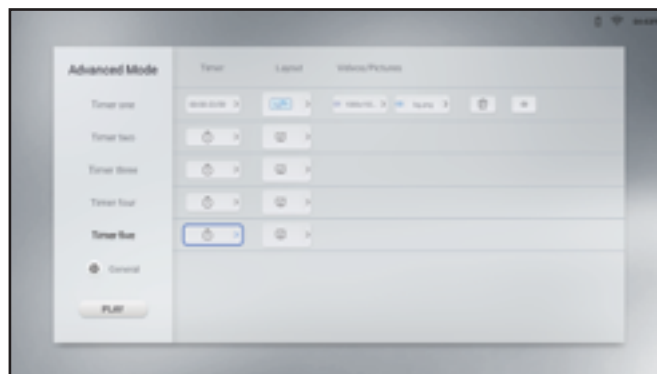

For **Advanced Mode**:



— Timer: Select the timer you want to modify from one to five. Then configure the following settings:

- Select the Timer field and set the play time. Then press **←** to return to the configuration page.
- Select the Layout field and set the layout for landscape or portrait mode. Then press **OK** to confirm.
- Ensure that the USB storage with the media files is plugged into the LCD display. Next, select the Videos and/or Pictures field and choose the media files for the currently selected timer. Press **OK** to confirm the selection and then press **←** to return to the configuration page.

Note:

- ◆ To remove the media files from the currently selected timer, select .
- ◆ To preview the media content once, select .

MULTIMEDIA MENU



— General: Select the picture duration and enable or disable the marquee settings. If you enable the marquee settings, then select the speed, orientation, and location for displaying the media content from the USB storage. Save the marquee settings to the TXT file and name the file as “pmd.txt”. Copy the file to the root directory of the USB storage together with your media files.

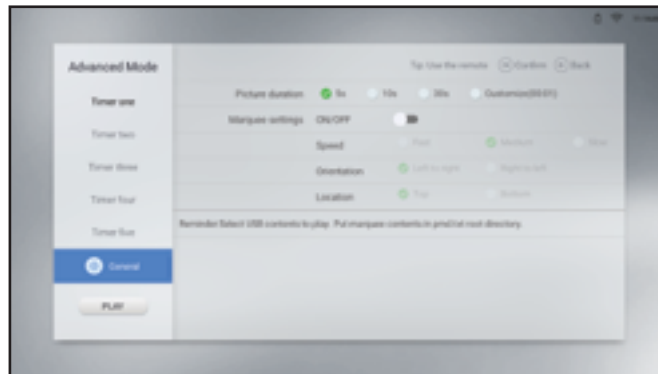

- 4 Select the display ratio when playing media content between **Scale** and **Full**. Set the ratio in the Settings > Screen Display > USB Scale Display menu. For more information, please see page 48.
 - Full: Images/videos fit the size of the screen.
 - Scale: Images/Videos are displayed in their original size.
- 5 Select **PLAY** to start the media player.

MULTIMEDIA MENU

4.4 Browser

Use Browser to save up to five bookmarks (URLs) manually or import a list of URLs from a USB storage. Then, display the web content on the screen.

To access Browser, press the  button and select the **Browser** as the source.

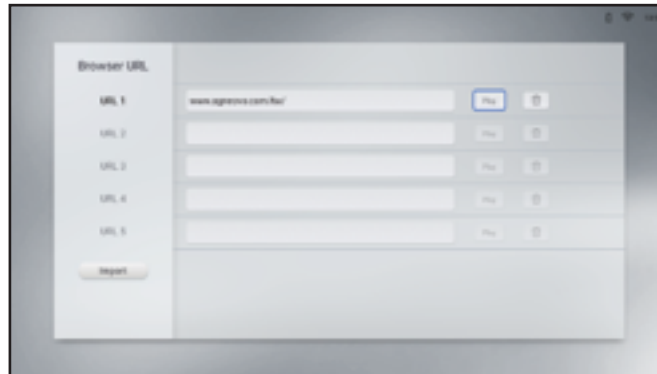

4.4.1 Adding and Managing URLs

To add URLs, do the following:

- 1 Select the URL from one to five.
- 2 Enter the website address.
- 3 Select **Play** to open the website.
- 4 Select  to delete the website address.
- 5 Select **IMPORT** to import up to five website addresses from a USB storage. Ensure that the USB storage is plugged into the LCD display.

MULTIMEDIA MENU

Note:

- ◆ To import the website addresses, save the addresses to the TXT file in the following format and name the file as browser_url.txt (without angle brackets):

```
<website 1>  
<%%!!&&@@>  
<website 2>  
<%%!!&&@@>  
<website 3>  
<%%!!&&@@>  
<website 4>  
<%%!!&&@@>  
<website 5>  
<%%!!&&@@>
```

For example:

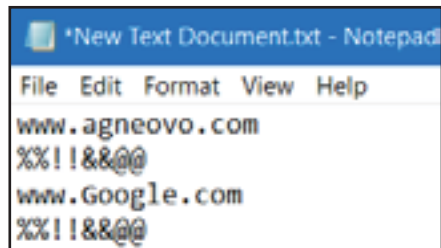

MULTIMEDIA MENU

4.5 Screen Sharing

Use Screen Sharing to mirror the screen of your iPhone, Windows, MAC, or Android device wirelessly to the LCD display.

To access Screen Sharing, press the  button and select the **Screen Sharing** as the source.

The launcher page will open:



- 1 Ensure that the LCD display is connected to Wi-Fi. For more information on connecting the LCD display to Wi-Fi, see page 53.
- 2 Connect your iPhone, Windows, MAC, or Android device to the same Wi-Fi network as the LCD display.
- 3 Select the device that you want to mirror to the LCD display from the launcher page and start mirroring.

For **Windows**:



a) Connect to the LCD display.

—In Windows 10, click on the Notification icon on the taskbar. Then click **Connect** > LCD display's name. For example, NSD 3_xx where "xx" are random numbers.

—In Windows 11, press the **Win+K** keys on the keyboard and search for nearby LCD displays. Then click on the LCD display's name. For example, NSD 3_xx where "xx" are random symbols.

b) Press the  button and select the connection mode, either **PPT Mode** (low latency, high sync) or **Video Mode** (smooth priority).

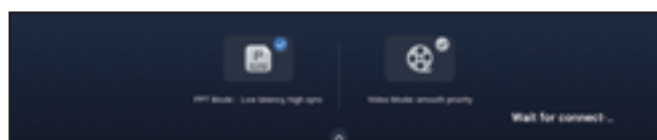

MULTIMEDIA MENU

For **MAC**:



Turn on the screen mirroring function in the status bar and click on the LCD display's name. For example, NSD 3_xx where "xx" are random numbers.

For **Android**:



Swipe down from the top of the screen to open the status bar. Next, tap on the wireless screencast function and finally, tap on the LCD display's name. For example, NSD 3_xx where "xx" are random numbers.

For **iPhone**:



Swipe down from the top of the screen to open the Control Center. Next, tap on the screen mirroring function and finally, tap on the LCD display's name. For example, NSD 3_xx where "xx" are random numbers.

- 4 Change the Device Name from "NSD 3_xx" to any name. Please note that "xx" are random numbers that cannot be modified. To change the device name, please see page 56.

MULTIMEDIA MENU

4.6 Apps Manager

On the All apps page, you can open, install, and uninstall apps.

To access the All Apps page, press the  button and select the **Apps** as the source.

The All Apps page will open:

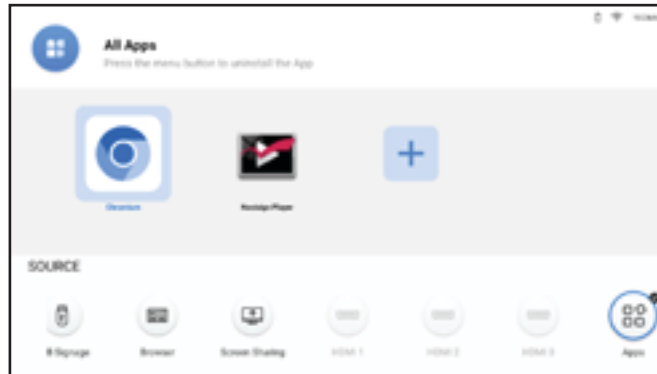

To open an app, simply select the app and press **OK**.

4.6.1 Installing Apps

To install more apps, do the following:

- 1 Download the app in your computer and save the APK file to your USB storage.
- 2 Connect the USB storage with the APK file to the LCD display.
- 3 Select  and press **OK**.
- 4 Select the app that you want to install and press **OK**.

When the installation is complete, then the app icon will appear on the All Apps page.



Note:

- ◆ If the APK file cannot be installed successfully, please ensure the following:
 - a) The APK is in the correct version.
 - b) The App Install Restriction Lock is not enabled. If it is enabled, then disable it in the Settings > Security menu. Please see page 62.

MULTIMEDIA MENU

4.6.2 Uninstalling Apps











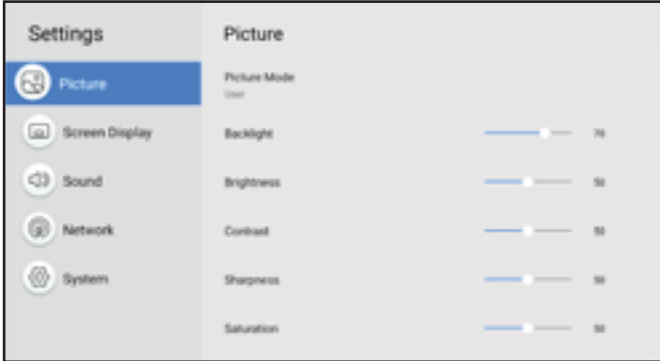



To uninstall an app, select the app and press  . On the deletion page, press **OK**.

Deletion page

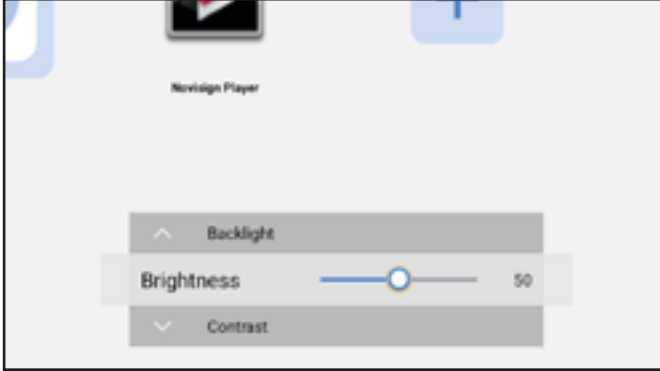

CHAPTER 5: ADJUSTING THE SETTINGS

5.1 Settings Menu

#	Menu Navigation	Operation
1	<p>Displays the Picture menu.</p> 	<p>Press the  button.</p>
2	<p>Enters the submenu.</p> 	<ol style="list-style-type: none"> 1 Press the  or  button to select the main menu item. 2 Press the  or OK button to enter the submenu. 3 Press the  or  button to select the submenu item. 4 Press the OK button to enter the adjustment mode.
3	<p>Adjusts the settings. For example, adjust brightness:</p> 	<ul style="list-style-type: none"> • Press the , or  button to adjust the value. • Press the  or  button to select the setting. Then press the OK button to confirm.
4	<p>Closes the Settings menu.</p>	<p>Wait until the Settings menu disappears automatically (around 30 seconds) or press the  button (repeatedly if necessary).</p>

ADJUSTING THE SETTINGS

When settings are modified, all changes are saved when the user does the following:

- Proceeds to another menu.
- Exits the Settings menu.
- Waits for the Settings menu to disappear.

Note:

- ◆ Availability of some menu items depend on the input source signal or selected setting. If the menu is not available, it is disabled and grayed out.

5.1.1 Settings Menu Tree

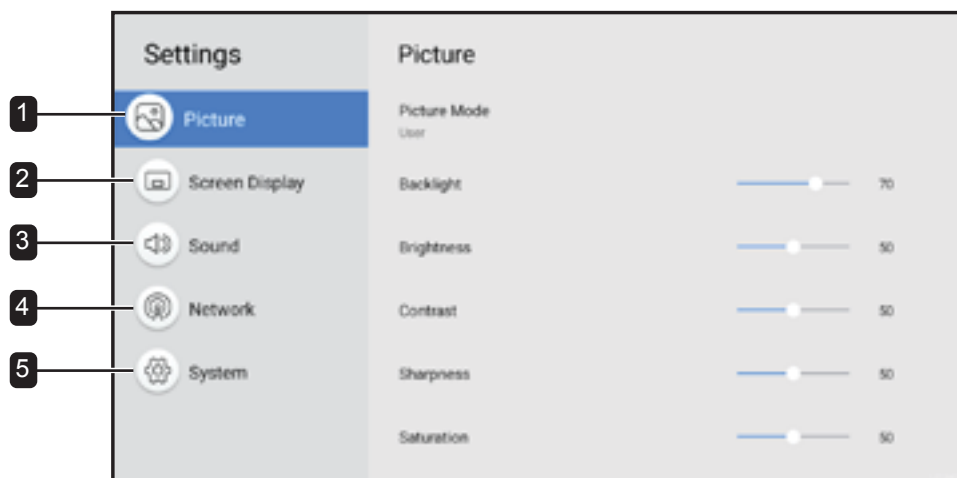

Main Menu	Submenu	Remarks
1. Picture	<ul style="list-style-type: none"> • Picture Mode • Backlight • Brightness • Contrast • Sharpness • Saturation • Colour Temperature • Colour Control • Colour Range • Reset Picture 	See page 46.
2. Screen Display	<ul style="list-style-type: none"> • Display Orientation • Aspect Ratio • USB Scale Display • Language • HDMI Version • Advanced Settings • Input Scheduling • Primary CMS 	See page 47.

ADJUSTING THE SETTINGS

Main Menu	Submenu	Remarks
3. Sound	<ul style="list-style-type: none">• Sound Mode• Balance• Equaliser• Reset Sound	See page 51.
4. Network	<ul style="list-style-type: none">• Network Type• Wi-Fi	See page 53.
5. System	<ul style="list-style-type: none">• Information• Start Setup• Date & Time• Power Management• Anti-Burn-In• Security• PC Connection Settings• Application• Custom Logo & Video• Upgrade System• System Reset	See page 56.

ADJUSTING THE SETTINGS

5.2 Configuring the Settings

5.2.1 Picture Menu



- 1 Press the button.
The Picture menu opens automatically.
- 2 Press the or **OK** button to enter the submenu.
- 3 Press the or button to select the submenu item.
- 4 Press the **OK** button to enter the adjustment mode.

Item	Function	Operation	Range
Picture Mode	Selects the best image quality option based on the usage scenario.	<ol style="list-style-type: none"> 1 Press the or button to select the setting. 2 Press the OK button to confirm. 	Standard Vivid Movie Monitor User
Backlight	Adjusts the level of backlight brightness that suits the best for your viewing preferences.	Press the or button to adjust the value.	0 to 100
Brightness	Adjusts the level of overall picture brightness that suits the best for your viewing preferences. Note: This item can be adjusted only if the Picture Mode is set to User .	Note: In the adjustment mode, press the or button and adjust additionally Backlight, Brightness, Contrast, Sharpness, and Saturation (if needed).	0 to 100
Contrast	Adjusts the level of overall picture contrast that suits the best for your viewing preferences. Note: This item can be adjusted only if the Picture Mode is set to User .		0 to 100
Sharpness	Adjusts the level of overall picture sharpness that suits the best for your viewing preferences. Note: This item can be adjusted only if the Picture Mode is set to User .		0 to 100
Saturation	Adjusts the level of overall picture saturation that suits the best for your viewing preferences. Note: This item can be adjusted only if the Picture Mode is set to User .		0 to 100

ADJUSTING THE SETTINGS

Item	Function	Operation	Range
Colour Temperature	Selects the colour temperature that suits the best for your viewing preferences. Note: This item can be adjusted only if the Picture Mode is set to User .	<ol style="list-style-type: none"> 1 Press the \wedge or \vee button to select the setting. 2 Press the OK button to confirm. 	Native Warm Cool User
Colour Control	Selects the colour RGB that suits the best for your viewing preferences. Note: This item can be adjusted only if the Picture Mode is set to User .	<ol style="list-style-type: none"> 1 Press the \wedge or \vee button to select the item (R, G, or B). 2 Press the \langle or \rangle button to adjust the value. 	0 to 255
Colour Range	Adjusts the black and white levels for the video source.	<ol style="list-style-type: none"> 1 Press the \wedge or \vee button to select the setting. 2 Press the OK button to confirm. 	AUTO Full LIMITED
Reset Picture	Restores all the Picture menu settings to the default settings.	<ol style="list-style-type: none"> 1 Press the \langle or \rangle button to select "Yes" or "No" tab. 2 Press the OK button to confirm. 	N/A

5.2.2 Screen Display Menu

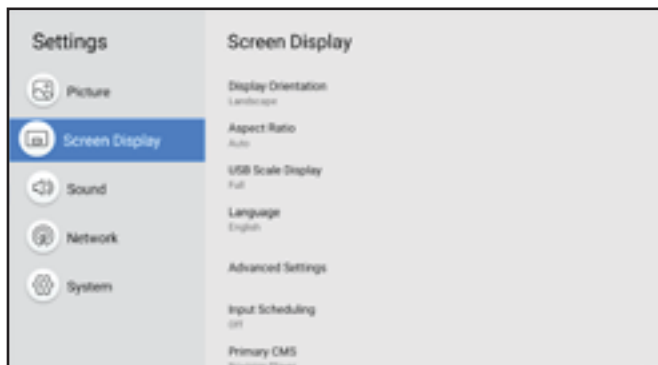

- 1 Press the ⚙ button.
- 2 Press the \wedge or \vee button to select the Screen Display menu.
- 3 Press the \rangle or **OK** button to enter the submenu.
- 4 Press the \wedge or \vee button to select the submenu item.
- 5 Press the **OK** button to enter the adjustment mode.

Item	Function	Operation	Range
Display Orientation	Select whether the screen should be displayed in landscape or portrait orientation. Note: This item is not supported if the source is HDMI.	<ol style="list-style-type: none"> 1 Press the \wedge or \vee button to select the setting. 2 Press the OK button to confirm. 	Landscape Portrait
Aspect Ratio	Selects the picture aspect ratio that suits the best for your viewing environment. Note: This item is available only for HDMI source.	<ol style="list-style-type: none"> 1 Press the \wedge or \vee button to select the setting. 2 Press the OK button to confirm. 	Auto 16:9 4:3

ADJUSTING THE SETTINGS

Item	Function	Operation	Range
USB Scale Display	Selects the USB scale display that suits the best for your viewing environment. Note: This item is available only for USB Signage source.	<ol style="list-style-type: none"> 1 Press the \wedge or \vee button to select the setting. 2 Press the OK button to confirm. 	Full Scale
Language	Selects the interface language.		English Deutsch Українська Italiano Español/ Français Русский Polski Dutch Magyar nyelv Dansk Čeština العربية Türkçe 繁體中文
HDMI Version	Selects the HDMI version.		HDMI 1.4 (NSD-3203/ NSD-4303 / NSD-5503 / NSD-6503) HDMI 2.0 (NSD-4303 / NSD-5503 / NSD-6503)

ADJUSTING THE SETTINGS

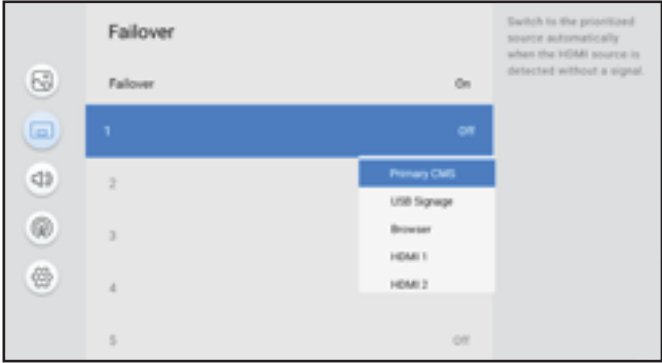
Item	Function	Operation	Range
Advanced Settings	Configures the relevant settings of the source signal.	N/A	Source Detect Boot on Source
	Source Detect: Switches to an active HDMI source when the primary source device is disconnected.	<ol style="list-style-type: none"> 1 Press the \wedge or \vee button to select the submenu item. 2 Press the OK button to confirm. 	Off On
	Failover: Switch to the prioritized source automatically when the HDMI source is detected without a signal.	<ol style="list-style-type: none"> 3 Press the \wedge or \vee button to select the setting. 4 Press the OK button to confirm. 	Off On
			
<p>Note: The functions of Source Detect and Failover conflict with each other. If users turn on Source Detect, Failover will not work, and vice versa.</p>			
	Boot on Source: Selects the signal source when restarting the LCD display.	<ol style="list-style-type: none"> 1 Press the \wedge or \vee button to select the submenu item. 2 Press the OK button to confirm. 3 Press the \wedge or \vee button to select the setting. 4 Press the OK button to confirm. 	Primary CMS USB Signage Browser Screen Sharing HDMI 1 HDMI 2 HDMI 3 Apps

ADJUSTING THE SETTINGS

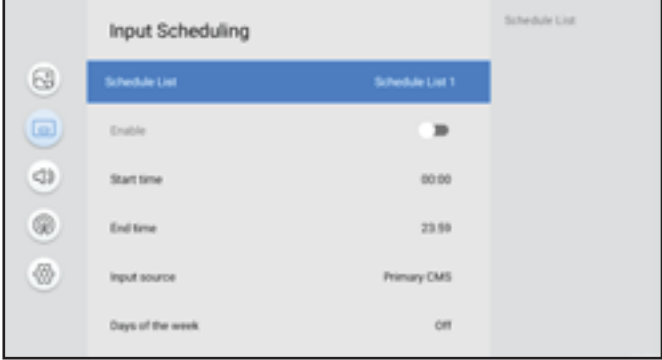
Item	Function	Operation	Range
Input Scheduling	Schedules playback of a specific signal source at the designated time according to your preferences.	N/A	Off Input Scheduling
			
	Schedule List: Selects the schedule list.	<ol style="list-style-type: none"> 1 Press the \wedge or \vee button to select the submenu item. 2 Press the OK button to confirm. 3 Press the \wedge or \vee button to select the setting. 4 Press the OK button to confirm. 	Schedule List 1 Schedule List 2 Schedule List 3 Schedule List 4 Schedule List 5 Schedule List 6 Schedule List 7
	<p>Enable: Enables or disables the schedule.</p> <p>Note: This item is available only if the schedule is active.</p>	<ol style="list-style-type: none"> 1 Press the \wedge or \vee button to select the submenu item. 2 Press the OK button to confirm. 3 Press the \wedge or \vee button to select the item. 4 Press the OK button to toggle the function on or off. 	Enabled Disabled
	Start time: Selects the start time of the schedule.	<ol style="list-style-type: none"> 1 Press the \wedge or \vee button to select the submenu item. 2 Press the OK button to confirm. 	00~23 (hours) 00~59 (minutes)
	End time: Selects the end time of the schedule.	<ol style="list-style-type: none"> 3 Press the \wedge or \vee button to select the hour. 4 Press the $\>$ button. 5 Press the \wedge or \vee button to select the minute. 	
Input source: Selects the input source.	<ol style="list-style-type: none"> 1 Press the \wedge or \vee button to select the submenu item. 2 Press the OK button to confirm. 3 Press the \wedge or \vee button to select the setting. 4 Press the OK button to confirm. 	Primary CMS USB Signage Browser HDMI 1 HDMI 2 HDMI 3	

ADJUSTING THE SETTINGS

Item	Function	Operation	Range
Input Scheduling	<p>Days of the week: Selects the days of the week when the schedule is enabled.</p> <p>Note: If you set the days of the week to Manual, then check the checkbox next to the day(s) when the schedule is active.</p>	<ol style="list-style-type: none"> 1 Press the \wedge or \vee button to select the submenu item. 2 Press the OK button to confirm. 3 Press the \wedge or \vee button to select the setting. 4 Press the OK button to confirm. 	Off Everyday Mon~Fri Mon~Sat Sat~Sun Manual
	<p>Repeat weekly: Enables or disables to repeat the schedule weekly.</p>	<ol style="list-style-type: none"> 1 Press the \wedge or \vee button to select the submenu item. 2 Press the OK button to confirm. 3 Press the \wedge or \vee button to select the item. 4 Press the OK button to toggle the function on or off. 	Enabled Disabled
Primary CMS	<p>Chooses the content management system that you primarily use. The source of the primary CMS will change based on this setting.</p>	<ol style="list-style-type: none"> 1 Press the \wedge or \vee button to select the setting. 2 Press the OK button to confirm. 	Novisign Player Other installed apps

5.2.3 Sound Menu

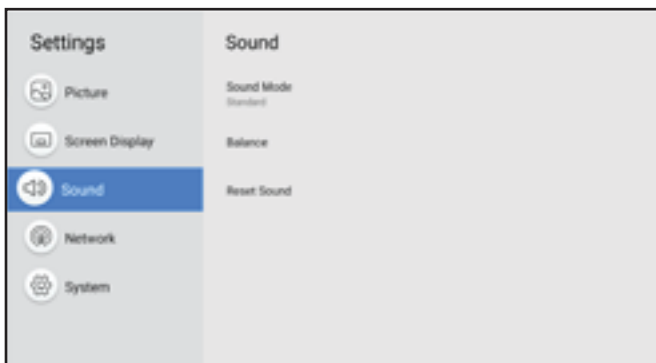

- 1 Press the \otimes button.
- 2 Press the \wedge or \vee button to select the Sound menu.
- 3 Press the \rangle or **OK** button to enter the submenu.
- 4 Press the \wedge or \vee button to select the submenu item.
- 5 Press the **OK** button to enter the adjustment mode.

Item	Function	Operation	Range
Sound Mode	<p>Selects the sound mode that best suits your audio environment.</p>	<ol style="list-style-type: none"> 1 Press the \wedge or \vee button to select the setting. 2 Press the OK button to confirm. 	Standard Music Movie User

ADJUSTING THE SETTINGS

Item	Function	Operation	Range
Balance	Adjusts the speaker volume levels to optimise your sound balance.	Press the < or > button to adjust the value.	L~0~R
			
	<p>Reset: Resets the balance settings to the default values.</p>	<ol style="list-style-type: none"> 1 Press the ∨, <, or > button to select the “Reset” tab. 2 Press the OK button to confirm. 	N/A
<p>Close: Closes the balance adjustment menu.</p>		N/A	
Equaliser	Adjusts the equaliser to customise the volume and pitch, and enhance the richness of the sound output.	<ol style="list-style-type: none"> 1 Press the ∧ or ∨ button to adjust the value. 2 Press the < or > button to move to the next frequency of sound adjustment. <p>Note: You can adjust the frequency of sound for 100Hz, 200Hz, 500Hz, 1kHz, and 2kHz.</p>	-10~10
	<p>Reset: Resets the equaliser settings to the default values.</p>	<ol style="list-style-type: none"> 1 Press the ∨, <, or > button to select the “Reset” tab. 2 Press the OK button to confirm. 	N/A
	<p>Close: Closes the equaliser adjustment menu.</p>		N/A
Reset Sound	Restores all sound settings to the default settings.	<ol style="list-style-type: none"> 1 Press the < or > button to select “Yes” or “No”. 2 Press the OK button to confirm. 	N/A

ADJUSTING THE SETTINGS

5.2.4 Network Menu



- 1 Press the button.
- 2 Press the \wedge or \vee button to select the Network menu.
- 3 Press the \rangle or **OK** button to enter the submenu.
- 4 Press the \wedge or \vee button to select the submenu item.
- 5 Press the **OK** button to enter the adjustment mode.

Item	Function	Operation	Range
Network Type	Configures network settings to connect to an available network.	<ol style="list-style-type: none"> 1 Press the \wedge or \vee button to select the setting. 2 Press the OK button to confirm. 	Wireless LAN Cable
Wi-Fi	<p>Enables the Wi-Fi function and configures the network settings to connect to an available Wi-Fi.</p> <p>Note: This item is available only if the Network Type is set to Wireless.</p>	<ol style="list-style-type: none"> 1 Press the \wedge or \vee button to select the Wi-Fi network you want to connect to. 2 Press the OK button. 3 Type in the password (if required). 4 Press the \wedge or \vee button to select the “Connect” tab. <p>Note: To disconnect from the Wi-Fi network, press the \wedge or \vee button to select the Wi-Fi network and then press the OK button. Press again the \wedge or \vee button to select Forget Network. Press the \wedge or \vee button to select the “OK” tab and then press the OK button to confirm.</p>	N/A
<p>The screenshot shows the 'Network' settings menu with 'Wi-Fi' now turned on, indicated by a green toggle switch. Below the 'Wi-Fi' header, there is a list of available Wi-Fi networks, each with a signal strength indicator, a name, and a lock icon. The first network is labeled 'Connected'.</p>			

ADJUSTING THE SETTINGS

Item	Function	Operation	Range
Connected/ Not Connected	<p>Displays the LAN connection status.</p> <p>Note:</p> <ul style="list-style-type: none"> This item is available only if the Network Type is set to LAN Cable. If the RJ45 cable is connected to the LCD display and the IP settings are configured correctly, then this item may be in the "Not Connected" state because the LAN Lock is enabled in the System > Security menu. Disable the LAN Lock. 	N/A	N/A
IP Settings	Configures the LAN connection parameters.	<ol style="list-style-type: none"> Press the \wedge or \vee button to select the setting. Press the OK button. 	N/A
	IP Setting: Selects the network type.	<ol style="list-style-type: none"> Press the \wedge or \vee button to select the setting. Press the OK button. 	DHCP Static
	IP Address: Enters the IP address.	<ol style="list-style-type: none"> Type in the first segment of the address. Press the \langle or \rangle button. Type in the next segment of the address. Repeat steps 2~3 until all four segments of the address are typed in. Press the \langle or \rangle button to select the "OK" tab. Press the OK button to confirm. 	0~255

ADJUSTING THE SETTINGS

Item	Function	Operation	Range
IP Settings	Gateway: Enters the gateway address.	<ol style="list-style-type: none"> 1 Type in the first segment of the address. 2 Press the < or > button. 3 Type in the next segment of the address. 4 Repeat steps 2~3 until all four segments of the address are typed in. 5 Press the < or > button to select the "OK" tab. 6 Press the OK button to confirm. 	0~255
	Subnet Mask: Enters the subnet mask address.	<ol style="list-style-type: none"> 1 Type in the first segment of the address. 2 Press the < or > button. 3 Type in the next segment of the address. 4 Repeat steps 2~3 until all four segments of the address are typed in. 5 Press the < or > button to select the "OK" tab. 6 Press the OK button to confirm. 	0~255
	DNS 1/DNS 2: Enters the DNS 1 & DNS 2 addresses.	<ol style="list-style-type: none"> 1 Type in the first segment of the address. 2 Press the < or > button. 3 Type in the next segment of the address. 4 Repeat steps 2~3 until all four segments of the address are typed in. 5 Press the < or > button to select the "OK" tab. 6 Press the OK button to confirm. 	0~255
	OK/Cancel: Confirms or discards the IP settings respectively.	<ol style="list-style-type: none"> 1 Press the < or > button to select the "OK" or "Cancel" tab. 2 Press the OK button to confirm. 	N/A

ADJUSTING THE SETTINGS

5.2.5 System Menu

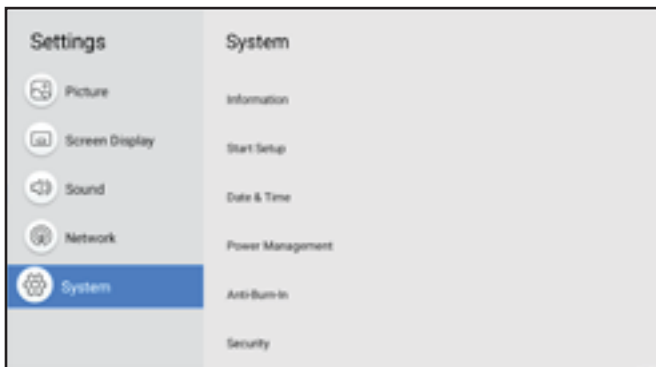

- 1 Press the button.
- 2 Press the \wedge or \vee button to select the System menu.
- 3 Press the \rangle or **OK** button to enter the submenu.
- 4 Press the \wedge or \vee button to select the submenu item.
- 5 Press the **OK** button to enter the adjustment mode.

Item	Function	Operation	Range
Information	Views this LCD display's information: <ul style="list-style-type: none"> • Software Version • Device Name • Model Name • Monitor ID • Wired MAC Address • Wired IP Address • Wireless MAC Address • Wireless IP Address • DDR RAM • Flash ROM • Internal Storage Free Space • Device Uptime 	N/A	N/A
	Device Name: Selects the LCD display's name.	<ol style="list-style-type: none"> 1 Press the \wedge or \vee button to select the submenu item. 2 Press the OK button. 3 Press the \wedge or \vee button to select the setting. 4 Press the OK button to confirm. <p>Note: If you select the User Input option, then type in the LCD display's name and press the \langle or \rangle button to select the "OK" or "Cancel" tab to either save or discard the setting respectively. Then press the OK button to confirm.</p>	NSD 3 User Input

ADJUSTING THE SETTINGS

Item	Function	Operation	Range
Information	Monitor ID: Enters the LCD display's ID if using multiple displays.	<ol style="list-style-type: none"> 1 Type in the monitor's ID. 2 Press the ∇ button. 3 Press the \langle or \rangle button to select the "OK" or "Cancel" tab. 4 Press the OK button to confirm. 	0~255
Start Setup	Initialises all items in the entire Settings menu. Follow the on-screen instructions to complete the initial setup.	Type in the Personal Identification Number (PIN).	N/A
Date & Time	Configures the current date & time settings.	N/A	N/A
	Automatic date & time: Sets whether to automatically determine the date and time.	<ol style="list-style-type: none"> 1 Press the \wedge or ∇ button to select the submenu item. 2 Press the OK button. 3 Press the \wedge or ∇ button to select the item. 4 Press the OK button to confirm. 	On Off
	Date: Sets the date. Note: This item is available only if the Automatic date & time is set to Off .	<ol style="list-style-type: none"> 1 Press the \wedge or ∇ button to select the submenu item. 2 Press the OK button. 3 Press the \wedge or ∇ button to select the day. 4 Press the \rangle button. 5 Repeat steps 3~4 to select the month and the year. 6 Press the OK button to confirm. 	1~31 (day) 1~12 (month) 20XX (year)
Time: Sets the time. Note: This item is available only if the Automatic date & time is set to Off .	<ol style="list-style-type: none"> 1 Press the \wedge or ∇ button to select the submenu item. 2 Press the OK button. 3 Press the \wedge or ∇ button to select the hour. 4 Press the \rangle button. 5 Repeat steps 3~4 to select the minutes. 6 Press the OK button to confirm. 	01~12 (hour) 00~59 (minute) AM/PM	

ADJUSTING THE SETTINGS

Item	Function	Operation	Range
NTP Settings	Sets up the server URL and time zone to use it as a source for obtaining the network time.	N/A	N/A
	Network Time Protocol: Enables or disables using the online time server.	<ol style="list-style-type: none"> 1 Press the \wedge or \vee button to select the submenu item. 2 Press the OK button. 3 Press the \wedge or \vee button to select the item. 4 Press the OK button to confirm. 	Use Don't use
	Server URL: Enters the NTP server URL. Note: This item is available only if the Network Time Protocol is set to Use .	<ol style="list-style-type: none"> 1 Press the \wedge or \vee button to select the submenu item. 2 Press the OK button. 3 Type in the URL. 4 Press the \vee button. 5 Press the \langle or \rangle button to select the "OK" or "Cancel" tab. 6 Press the OK button to confirm. 	0~255 (symbols)
	Time Zone: Selects the time zone.	<ol style="list-style-type: none"> 1 Press the \wedge or \vee button to select the submenu item. 2 Press the OK button. 3 Press the \wedge or \vee button to select the item. 4 Press the OK button to confirm. 	Midway GMT-11:00~ Tongatapu GMT+13:00
	Use 24-hour format: Sets the hour format.	<ol style="list-style-type: none"> 1 Press the \wedge or \vee button to select the submenu item. 2 Press the OK button to toggle the function on or off. 	Enabled Disabled
	OK/Cancel: Confirms or discards the NTP settings respectively.	<ol style="list-style-type: none"> 1 Press the \vee button to select the submenu item. 1 Press the \langle or \rangle button to select the "Save" or "Cancel" tab. 2 Press the OK button to confirm. 	N/A
Power Management	Configures the LCD display's power settings.	N/A	N/A

ADJUSTING THE SETTINGS

Item	Function	Operation	Range
Power Management	Energy Saving Mode Enable in: The system enables power saving mode when no signal is detected within the assigned time period.	<ol style="list-style-type: none"> 1 Press the \wedge or \vee button to select the submenu item. 2 Press the OK button. 3 Press the \wedge or \vee button to select the setting. 4 Press the OK button to confirm. 	Off 10 minutes 15 minutes 30 minutes 45 minutes 60 minutes
	Energy Saving By: Saves energy when there is no signal. The system enters the standby/sleep mode.	<ol style="list-style-type: none"> 1 Press the \wedge or \vee button to select the submenu item. 2 Press the OK button. 3 Press the \wedge or \vee button to select the setting. 4 Press the OK button to confirm. 	Standby Sleep
	On/Off Timer: Sets the LCD display to turn on or off at a fixed time. a) Enable or disable the on/off timer. b) Set the on timer. c) Set the off timer.	<ol style="list-style-type: none"> 1 Press the \wedge or \vee button to select the submenu item. 2 Press the OK button. 3 Press the \wedge or \vee button to select the items in the submenu. 4 Press the OK button. 	N/A
	- On/Off Timer Mode: Selects the mode of the on/off timer. - Off: Timer is off. - Standard: Follows the on/off timer that is set in the Settings menu. - Play Time: Follows the on/off timer that is set in the USB signage menu.	<ol style="list-style-type: none"> 1 Press the \wedge or \vee button to select the setting. 2 Press the OK button to confirm. 	Off Standard Play Time
	- On Timer: Sets the LCD display to turn on at a fixed time. Then select the day and time.	<ol style="list-style-type: none"> 1 Press the \wedge or \vee button to select the item in the submenu. 2 Press the OK button. Then select the day and time when the LCD display will be turned on. 	Off On
	- Off Timer: Sets the LCD display to turn off at a fixed time. Then select the day and time.	<ol style="list-style-type: none"> 1 Press the \wedge or \vee button to select the item in the submenu. 2 Press the OK button. Then select the day and time when the LCD display will be turned off. 	Off On
	Power Control: Configures various power related settings.	N/A	N/A

ADJUSTING THE SETTINGS

Item	Function	Operation	Range
Power Management	- Auto Power On: Turns on the LCD display automatically when the display is connected to the power source.	<ol style="list-style-type: none"> 1 Press the \wedge or \vee button to select the submenu item. 2 Press the OK button to toggle the function on or off. 	Enabled Disabled
	- HDMI Wake-Up: Turns on or wakes up the LCD display from the sleep or standby state when the HDMI signal is detected.	<ol style="list-style-type: none"> 1 Press the \wedge or \vee button to select the submenu item. 2 Press the OK button to toggle the function on or off. 	Enabled Disabled
	- Wake On LAN: Turns on or wakes up the LCD display from the sleep or standby state by a network message.	<ol style="list-style-type: none"> 1 Press the \wedge or \vee button to select the submenu item. 2 Press the OK button to toggle the function on or off. 	Enabled Disabled
	- Power Button: Configures the power button behaviour of the LCD display and remote control.	<ol style="list-style-type: none"> 1 Press the \wedge or \vee button to select the setting. 2 Press the OK button to confirm. 	Power on only Power on and Standby Sleep
Anti-Burn-In	Selects the time interval in seconds for the LCD display to slightly expand the image size and shifts the position of pixels in four directions (up, down, left, and right).	N/A	N/A
	Message: Reminds about the Anti-Burn-in™ process.	<ol style="list-style-type: none"> 1 Press the \wedge or \vee button to select the submenu item. 2 Press the OK button to toggle the function on or off. 	Enabled Disabled
	Timer: Selects the interval time (hour) between activating the function.	<ol style="list-style-type: none"> 1 Press the \wedge or \vee button to select the submenu item. 2 Press the OK button. 3 Press the \wedge or \vee button to select the setting. 4 Press the OK button to confirm. 	1 Hour 2 Hour 3 Hour 7 Hour
Security	Configures the security settings of the LCD display.	Type in the PIN.	N/A

ADJUSTING THE SETTINGS

Item	Function	Operation	Range
Security	Change Password: Changes your 6-digit PIN.	<ol style="list-style-type: none"> 1 Press the \wedge or \vee button to select the submenu item. 2 Press the OK button. 3 Enter a new PIN. 4 Press the \vee button. 5 Enter the new PIN again. 	N/A
			
	Remote Control Lock All: Enables or disables operating the LCD display by using the remote control.	<ol style="list-style-type: none"> 1 Press the \wedge or \vee button to select the submenu item. 2 Press the OK button to toggle the function on or off. 	Enabled Disabled
	Remote Control Lock (Except Power Key): Enables or disables operating the LCD display by using the remote control. If the function is enabled, then all the remote control buttons are disabled, except for the power button.	<ol style="list-style-type: none"> 1 Press the \wedge or \vee button to select the submenu item. 2 Press the OK button to toggle the function on or off. 	Enabled Disabled
	Monitor Button Lock: Enables or disables the operation of the power button of the LCD display.	<ol style="list-style-type: none"> 1 Press the \wedge or \vee button to select the submenu item. 2 Press the OK button to toggle the function on or off. 	Enabled Disabled
	USB Auto Play Lock: Enables or disables playing the content from the USB storage that is plugged into the LCD display.	<ol style="list-style-type: none"> 1 Press the \wedge or \vee button to select the submenu item. 2 Press the OK button to toggle the function on or off. 	Enabled Disabled
	USB Lock: Enables or disables displaying the content of the USB storage that is plugged into the LCD display.	<ol style="list-style-type: none"> 1 Press the \wedge or \vee button to select the submenu item. 2 Press the OK button to toggle the function on or off. 	Enabled Disabled
	HDMI Lock: Enables or disables screen sharing for the HDMI sources.	<ol style="list-style-type: none"> 1 Press the \wedge or \vee button to select the submenu item. 2 Press the OK button to toggle the function on or off. 	Enabled Disabled

ADJUSTING THE SETTINGS

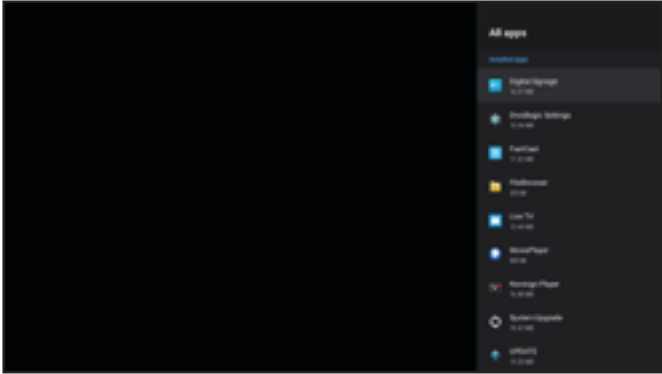

Item	Function	Operation	Range
Security	LAN Lock: Enables or disables the LAN connection.	<ol style="list-style-type: none"> 1 Press the \wedge or \vee button to select the submenu item. 2 Press the OK button to toggle the function on or off. 	Enabled Disabled
	External Commands Lock: Enables or disables controlling the LCD display remotely over the RS232 connection.	<ol style="list-style-type: none"> 1 Press the \wedge or \vee button to select the submenu item. 2 Press the OK button to toggle the function on or off. 	Enabled Disabled
	App Install Restriction Lock: Enables or disables installing the third-party apps.	<ol style="list-style-type: none"> 1 Press the \wedge or \vee button to select the submenu item. 2 Press the OK button to toggle the function on or off. 	Enabled Disabled
PC Connection Settings	Selects which type of cable you are using to connect the LCD display to the PC.	N/A	N/A
	PC Connection Cable: Selects the PC connection cable.	<ol style="list-style-type: none"> 1 Press the \wedge or \vee button to select the submenu item. 2 Press the OK button. 3 Press the \wedge or \vee button to select the setting. 4 Press the OK button to confirm. 	RS232C cable Network
	<p>Port: Selects the network port number.</p> <p>Note: This item is available only if the PC Connection Cable is set to Network.</p>	<ol style="list-style-type: none"> 1 Press the \wedge or \vee button to select the submenu item. 2 Press the OK button. 3 Type in the network port number. 4 Press the \vee button to select the "Done" tab. 5 Press the OK button to confirm. 	N/A
Application	Enables to view the storage of all the apps that are installed to the LCD display.	N/A	N/A
			

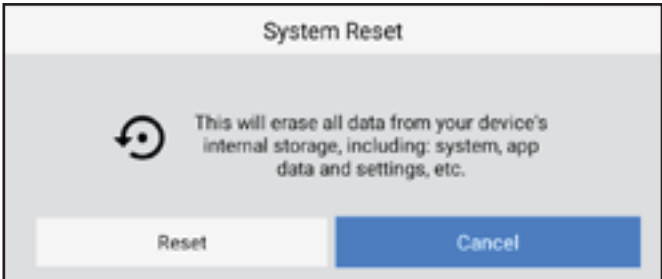
ADJUSTING THE SETTINGS

Item	Function	Operation	Range
Custom Logo & Video	<p>Replaces the logo image and the boot animation of the LCD display. The modifications will take effect after you restart the display.</p> <p>Note:</p> <ul style="list-style-type: none"> Save the logo image and the boot animation to the root directory of the USB storage. Then connect the USB storage to the LCD display. The logo image and the boot animation need to match the following requirements: <ul style="list-style-type: none"> The logo file must be 1080P, BMP, RGB_565, or RGB_888, and the file name must be "BootImage.bmp" (without the quotation marks). The boot animation must be saved in 1080P, MP4 format and the file name must be "BootVideo.mp4" (without the quotation marks). 	N/A	N/A
Upgrade System	Upgrades the firmware of the LCD display. Click to check if there is a new version to upgrade the system.	N/A	N/A
System Reset	Erases all data from the internal storage of the LCD display, including the system, app data, settings, and more.	<ol style="list-style-type: none"> Type in the PIN. Press the < or > button to select the "Reset" or "Cancel" tab. Press the OK button to confirm. Press the < or > button to select the "Erase everything" or "Cancel" tab. Press the OK button to confirm. 	N/A
			

CHAPTER 6: APPENDIX

6.1 Warning Messages

Warning Messages	Cause	Solution
	The LCD display cannot detect the input source signal.	<ul style="list-style-type: none"> • Check if the input source is turned ON. • Check if the signal cable is properly connected. • Check if any pin inside the cable connector is twisted or broken.
	This warning message pops up only when the function in the Settings menu is changed for the first time.	<p>Press the OK button (the “ACCEPT” tab is selected by default) to continue the setting changes, or select the “CANCEL” tab and press the OK button to disable the setting changes.</p> <p>Note: The operation may vary from different product models.</p>

6.2 Supported Media Formats

Video Format

Container	File Extension	Codec
AVI	*.avi	H.264BP
		H.264MP
		H.264HP
		MPEG4 SP
		MPEG
		Motion JPEG
		VC-1
		WMV9
		RV40(Real Player 9)
		H264
MKV	*.mkv	H.264BP
		H.264MP
		H.264HP
		Windows Media Video 9
		VC-1
		VP8
		MPEG2
MVB	rmvb	RealVideo 4

APPENDIX

Container	File Extension	Codec
ASF	*.asf	Windows Media Video V7
		Windows Media Video V8
		Windows Media Video V9
		VC-1
WMV	*.wmv	Windows Media Video V7
		Windows Media Video V8
		Windows Media Video V9
		VC-1 MP@LL
		VC-1 MP@ML
		WVC1
		H.264
MP4	*.mp4	H.264BP
		H.264MP
		H.264HP
		MPEG4 SP
		MPEG4 ASP
		MPEG2 MP@HL
		XviD
		H.265
		H.263
		MOV
H.264MP		
H.264HP		
M4V	*.m4v	H.264BP
		H.264MP
		H.264HP
M2V	.m2v	MPEG2

Audio Format

Container	File Extension	Codec
3gp	*.3gp	H.264BP
		H.264MP
		H.264HP
		MPEG4 SP
		MPEG4 ASP
		H.263
		AVC
		MPEG-4 Visual
PS	*.mpg *.mpeg *.dat *.vob	MPEG1
		MPEG2 MP@ML
		MPEG2 HP@HL
TS	*.ts *.tp *.trp *.m2ts *.mpg	H.264BP
		H.264MP
		AVS
		H.265

APPENDIX

Container	File Extension	Codec
RM	*.rm *.rmvb	Legacy (rv 10, rv 13)
		RV G2 (rv20)
		RV 8 (rv30)
		RV 9 (rv40)
		H.264
Others	*.webm *.m2v *.swf *.mxf	webm
		m2v
		swf
AVC(H.264)	*.avi	AVC
HDR	*.ts	HEVC
TS	*.ts	HEVC
		MPEG2 AVC
TS	*.ts	MPEG2 MP
PS	*.mpg	MPEG2 MP
MKV	*.mkv	H264 MP
AVI	*.avi	MPEG4 ASP
WMV	*.wmv	VC-1
MKV	*.mkv	H264 HP
AVI	*.avi	XVID
TS	*.ts	H264 HP
AVI	*.avi	H264 HP
TS	*.ts	H264 HP
MP4	*.mp4	H264 HP
		H264 BP
		H264
	*.mov	H264 HP
MP2	*.mpeg	MPEG2 MP@HL
TS	*.mpg	MPEG2 MP@HL
TS	*.mpg	H254 HP@L3.0
MP4	*.mp4	H264 HP@L4.1

Image Format

Format	File Extension
PICTURE	JPG
	PNG
	GIF

Note:

- ◆ Sound or video may not work if the contents have a standard bit rate/frame rate above the compatible Frame/sec listed in the table above.
- ◆ Video content with a Bit rate or Frame rate larger than the rate specified in the table above can cause choppy video during playback.

APPENDIX

6.3 Supported Timings

NSD-3203

PC Timing								
Timing		fh (kHz)	fv (Hz)	Dot clock (MHz)	HDMI1	HDMI2	HDMI3	
VESA	VGA	640 x 480	31.50	59.94	25.17	0	0	0
	SVGA	800 x 600	37.90	60.31	40.00	0	0	0
	XGA	1024 x 768	48.40	60.00	65.00	0	0	0
	QXGA	1280 x 960	64.00	60.00	108.00	0	0	0
	SXGA	1280 x 1024	64.00	60.02	108.00	0	0	0
	CVT	1440 x 900	55.90	60.00	106.50	0	0	0
	UXGA	1680 x 1050	65.30	59.95	146.25	0	0	0
	FHD	1920 x 1080	67.50	60.00	148.50	0	0	0
SD	480i	60Hz	15.73	59.94	27.00	0	0	0
	576i	50Hz	15.62	50.00	13.50	0	0	0
	480P	60Hz	31.46	59.94	27.00	0	0	0
	576P	50Hz	31.25	50.00	27.00	0	0	0
HD	720P	24Hz	18.00	24.00	59.40	0	0	0
		30Hz	22.50	30.00	74.25	0	0	0
		50Hz	37.50	50.00	27.00	0	0	0
		60Hz	45.00	60.00	74.25	0	0	0
	1080i	50Hz	28.12	50.00	74.25	0	0	0
		60Hz	33.71	60.00	74.25	0	0	0
	1080p	24Hz	26.28	24.00	74.25	0	0	0
		30Hz	33.75	30.00	74.25	0	0	0
		50Hz	56.25	50.00	148.50	0	0	0
		60Hz	67.50	60.00	148.50	0	0	0

APPENDIX

NSD-4303

PC Timing									
Timing		fh (kHz)	fv (Hz)	Dot clock (MHz)	HDMI1	HDMI2	HDMI3		
VESA	VGA	640 x 480	31.50	59.94	25.17	○	○	○	
	SVGA	800 x 600	37.90	60.31	40.00	○	○	○	
	XGA	1024 x 768	48.40	60.00	65.00	○	○	○	
	QXGA	1280 x 960	64.00	60.00	108.00	○	○	○	
	SXGA	1280 x 1024	64.00	60.02	108.00	○	○	○	
	CVT	1440 x 900	55.90	60.00	106.50	○	○	○	
	UXGA	1680 x 1050	65.30	59.95	146.25	○	○	○	
	FHD	1920 x 1080	67.50	60.00	148.50	○	○	○	
	UHD	3840 x 2160	135.00	60.00	594.00	○	○	○	
SD	480i	60Hz	15.73	59.94	27.00	○	○	○	
	576i	50Hz	15.62	50.00	13.50	○	○	○	
	480P	60Hz	31.46	59.94	27.00	○	○	○	
	576P	50Hz	31.25	50.00	27.00	○	○	○	
HD	720P	24Hz	18.00	24.00	59.40	○	○	○	
		30Hz	22.50	30.00	74.25	○	○	○	
		50Hz	37.50	50.00	27.00	○	○	○	
		60Hz	45.00	60.00	74.25	○	○	○	
	1080i	50Hz	28.12	50.00	74.25	○	○	○	
		60Hz	33.71	60.00	74.25	○	○	○	
	1080p	24Hz	26.28	24.00	74.25	○	○	○	
		30Hz	33.75	30.00	74.25	○	○	○	
		50Hz	56.25	50.00	148.50	○	○	○	
		60Hz	67.50	60.00	148.50	○	○	○	
	UHD	2160p	30Hz	33.75	30.00	74.25	○	○	○
			60Hz	135.00	60.00	594.00	○	○	○

APPENDIX

NSD-5503 & NSD-6503



PC Timing								
Timing		fh (kHz)	fv (Hz)	Dot clock (MHz)	HDMI1	HDMI2	HDMI3	
VESA	VGA	640 x 480	31.50	59.94	25.17	○	○	○
	SVGA	800 x 600	37.90	60.31	40.00	○	○	○
	XGA	1024 x 768	48.40	60.00	65.00	○	○	○
	QXGA	1280 x 960	64.00	60.00	108.00	○	○	○
	SXGA	1280 x 1024	64.00	60.02	108.00	○	○	○
	CVT	1440 x 900	55.90	60.00	106.50	○	○	○
	UXGA	1680 x 1050	65.30	59.95	146.25	○	○	○
	FHD	1920 x 1080	67.50	60.00	148.50	○	○	○
	UHD	3840 x 2160	135.00	60.00	594.00	○	○	○
SD	480i	60Hz	15.73	59.94	27.00	○	○	○
	576i	50Hz	15.62	50.00	13.50	○	○	○
	480P	60Hz	31.46	59.94	27.00	○	○	○
	576P	50Hz	31.25	50.00	27.00	○	○	○
HD	720P	24Hz	18.00	24.00	59.40	○	○	○
		30Hz	22.50	30.00	74.25	○	○	○
		50Hz	37.50	50.00	27.00	○	○	○
		60Hz	45.00	60.00	74.25	○	○	○
	1080i	50Hz	28.12	50.00	74.25	○	○	○
		60Hz	33.71	60.00	74.25	○	○	○
	1080p	24Hz	26.28	24.00	74.25	○	○	○
		30Hz	33.75	30.00	74.25	○	○	○
		50Hz	56.25	50.00	148.50	○	○	○
		60Hz	67.50	60.00	148.50	○	○	○
UHD	2160p	30Hz	67.50	30.00	297.00	○	○	○
		60Hz	135.00	60.00	594.00	○	○	○

General guidelines:

- NSD-4303/5503/6503 support 4K. The PC text quality is optimum in 4K mode (3840x2160 60Hz).
- For NSD-3203, the PC text quality is optimum in HD 1080 mode (1920 x 1080, 60 Hz).
- Your PC display screen might appear different depending on the manufacturer (and your particular version of Windows).
- Check your PC instruction book for information about connecting your PC to a display.
- When horizontal synchronous signals seem irregular in RGB mode, check PC standby mode or cable connections.
- The display settings table complies to the IBM/VESA standards, and based on the analog input.
- The best timing for the vertical frequency to each mode is 60 Hz.

APPENDIX

6.4 Troubleshooting

Symptom	Possible Cause	Remedy
No picture is displayed	<ul style="list-style-type: none"> The power cord has been disconnected. The selected input has no connection. The display is in standby mode. 	<ol style="list-style-type: none"> 1 Plug in the power cord. 2 Connect a signal connection to the display.
Interference displayed on the display or audible noise is heard	Caused by surrounding electrical appliances or fluorescent lights.	Move the display to another location to see if the interference is reduced or connect the display to another power outlet.
Colour is abnormal	The signal cable is not connected properly.	Make sure that the signal cable is attached firmly to the display.
Picture is distorted with abnormal patterns	<ul style="list-style-type: none"> The signal cable is not connected properly. The input signal is beyond the capabilities of the display. 	<ul style="list-style-type: none"> Make sure that the signal cable is attached firmly. Check the video signal source to see if it is beyond the range of the display. Please verify its specifications with this display's specification section.
Display image doesn't fill up the full size of the screen	The picture format is not set correctly.	Open the Settings menu > Screen Display > Aspect Ratio and try the different formats. See page 47.
Can hear sound, but no picture	Improperly connected source signal cable.	Make sure that both video inputs and sound inputs are correctly connected.
Can see picture but no sound is heard	<ul style="list-style-type: none"> Improperly connected source signal cable. Volume is turned all the way down. Mute function is turned on. No external speaker connected. 	<ul style="list-style-type: none"> Make sure that both video and sound inputs are correctly connected. Press the  button to hear the sound. Unmute the LCD display by pressing the  button on the remote control. Connect the external speakers and adjust the volume to a suitable level.
Some picture elements do not light up	Some pixels of the display may not turn on.	This display is manufactured using an extremely high level of precision technology: however, sometimes some pixels of the display may not display. This is not a malfunction.
After-Images can still be seen on the display after the display is powered off. (Examples of still pictures include logos, video games, computer images, and images displayed in 4:3 normal mode)	A still picture is displayed for an over extended period of time.	Do not allow a still image to be displayed for an extended period of time as this can cause a permanent after-image to remain on the display. enable the Settings menu > System > Anti-Burn-In function. See page 60.

APPENDIX

6.5 Transporting the LCD Display

To transport the LCD display for repair or shipment, place the display in its original packaging carton.

For NSD-3203 & NSD-4303

- 1 Use two persons to lift the LCD display (a).



Warning:

- ◆ Do not press too hard on the LCD display or edge of the frame, as this may cause the device to malfunction.
- 2 Place the LCD display (b) inside the lower foam cushion.
 - 3 Place the upper foam cushions (c) on top of the LCD display.
 - 4 Place the accessories on the designated area inside the box (if necessary).
 - 5 Close and tape the box (d).

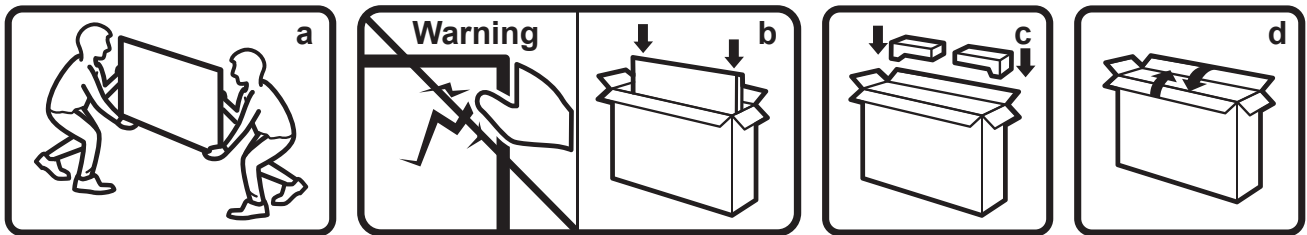

For NSD-5503 & NSD-6503

- 1 Use two persons to lift the LCD display (a).



Warning:

- ◆ Do not press too hard on the LCD display or edge of the frame, as this may cause the device to malfunction.
- 2 Place the LCD display inside the lower foam cushion in the lower box.
 - 3 Place the upper box (b) on the LCD display.
 - 4 Place the upper foam cushions (c) on top of the LCD display.
 - 5 Place the accessories on the designated area inside the box (if necessary).
 - 6 Close and tape the box (d).

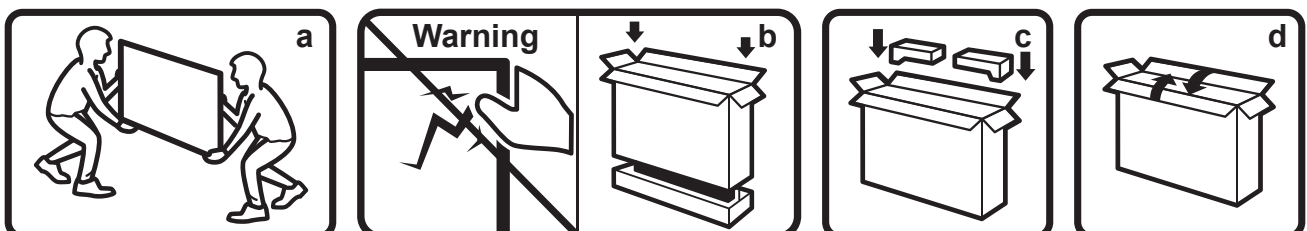

CHAPTER 7: SPECIFICATIONS

7.1 Display Specifications

		NSD-3203	NSD-4303	NSD-5503	NSD-6503
Panel	Panel Type	LED-Backlit TFT LCD (VA Technology)	LED-Backlit TFT LCD (VA Technology)	LED-Backlit TFT LCD (VA Technology)	LED-Backlit TFT LCD (VA Technology)
	Panel Size	31.5"	42.5"	54.6"	64.5"
	Max. Resolution	FHD 1920 x 1080	UHD 3840 x 2160	UHD 3840 x 2160	UHD 3840 x 2160
	Pixel Pitch	0.364 mm	0.245 mm	0.315 mm	0.372 mm
	Brightness	500cd/m ²	500cd/m ²	500cd/m ²	500cd/m ²
	Contrast Ratio	4000:1	4000:1	4000:1	5000:1
	Viewing Angle (H/V)	178°/178°	178°/178°	178°/178°	178°/178°
	Display Colour	16.7M	1.07G	1.07G	1.07G
	Response Time	5 ms	5 ms	5 ms	5 ms
Surface Treatment	Haze 25%, Hard Coating(3H)	Haze 25%, Hard Coating(3H)	Haze 25%, Hard Coating(3H)	Haze 25%, Hard Coating(3H)	
Frequency (H/V)	H Freq.	18 kHz-68 kHz	18 kHz-135 kHz	18 kHz-135 kHz	18 kHz-135 kHz
	V Freq.	24 Hz-60 Hz	24 Hz-60 Hz	24 Hz-60 Hz	24 Hz-60 Hz
Input	HDMI	2.0 x 3	2.0 x 3	2.0 x 3	2.0 x 3
External Control	RS232 In	9-Pin D-Sub x 1	9-Pin D-Sub x 1	9-Pin D-Sub x 1	9-Pin D-Sub x 1
	LAN (RJ45)	RJ45 x 1	RJ45 x 1	RJ45 x 1	RJ45 x 1
Embedded System	OS	Android 9.0	Android 9.0	Android 9.0	Android 9.0
	CPU	A35*4	A35*4	A35*4	A35*4
	Memory	2G	2G	2G	2G
	Storage	16G	16G	16G	16G
Other Connectivity	USB	2.0 x 2 (Service Port / Media Playback)	2.0 x 2 (Service Port / Media Playback)	2.0 x 2 (Service Port / Media Playback)	2.0 x 2 (Service Port / Media Playback)
Audio	Audio Out	Stereo Audio Jack (3.5 mm) x 1	Stereo Audio Jack (3.5 mm) x 1	Stereo Audio Jack (3.5 mm) x 1	Stereo Audio Jack (3.5 mm) x 1
	Internal Speakers	10W x 2	10W x 2	10W x 2	10W x 2
Power	Power Supply	Internal	Internal	Internal	Internal
	Power Requirements	AC 100-240V, 50/60 Hz	AC 100-240V, 50/60 Hz	AC 100-240V, 50/60 Hz	AC 100-240V, 50/60 Hz
	On Mode	40W (On)	73W (On)	89W (On)	101W (On)
	Standby Mode	< 0.5W	< 0.5W	< 0.5W	< 0.5W
Operating Conditions	Temperature	0°C-40°C (32°F-104°F)	0°C-40°C (32°F-104°F)	0°C-40°C (32°F-104°F)	0°C-40°C (32°F-104°F)
	Humidity	20%-80% (non-condensing)	20%-80% (non-condensing)	20%-80% (non-condensing)	20%-80% (non-condensing)
Storage Conditions	Temperature	-20°C-60°C (-4°F-140°F)	-20°C-60°C (-4°F-140°F)	-20°C-60°C (-4°F-140°F)	-20°C-60°C (-4°F-140°F)
	Humidity	20%-80% (non-condensing)	20%-80% (non-condensing)	20%-80% (non-condensing)	20%-80% (non-condensing)
Mounting	VESA FPMPI	150 mm x 200 mm	400 mm x 300 mm	300 mm x 400 mm	400 mm x 400 mm
Dimensions	Bezel Width	Even bezel 8.8 mm	Even bezel 8.7 mm	13.3 mm (Top/Left/Right) 15.3 mm (Bottom)	14 mm (Top/Left/Right) 16 mm (Bottom)
	Product w/o Base (W x H x D)	724.6 x 419.8 x 40 mm (28.5" x 16.5" x 1.6")	967.4 x 555.9 x 40 mm (38.1" x 21.9" x 1.6")	1239.7 x 712.5 x 38.6 mm (48.8" x 28.1" x 1.5")	1459.2 x 837.1 x 38.9 mm (57.4" x 33.0" x 1.5")
	Packaging (W x H x D)	795 x 520 x 115 mm (31.3" x 20.5" x 4.5")	1075 x 652 x 144 mm (42.3" x 25.7" x 5.7")	1390 x 850 x 136 mm (54.7" x 33.5" x 5.4")	1640 x 990 x 164 mm (64.6" x 39.0" x 6.5")
Weight	Product w/o Base	5.4 kg (11.9 lb)	9.1 kg (20.0 lb)	17.6 kg (38.8 lb)	25.3 kg (55.8 lb)
	Packaging	7.0 kg (15.4 lb)	12.0 kg (26.5 lb)	22.2 kg (48.9 lb)	33.8 kg (74.5 lb)

Note:

- ◆ All specifications are subject to change without prior notice.

SPECIFICATIONS

7.2 Display Dimensions

NSD-3203

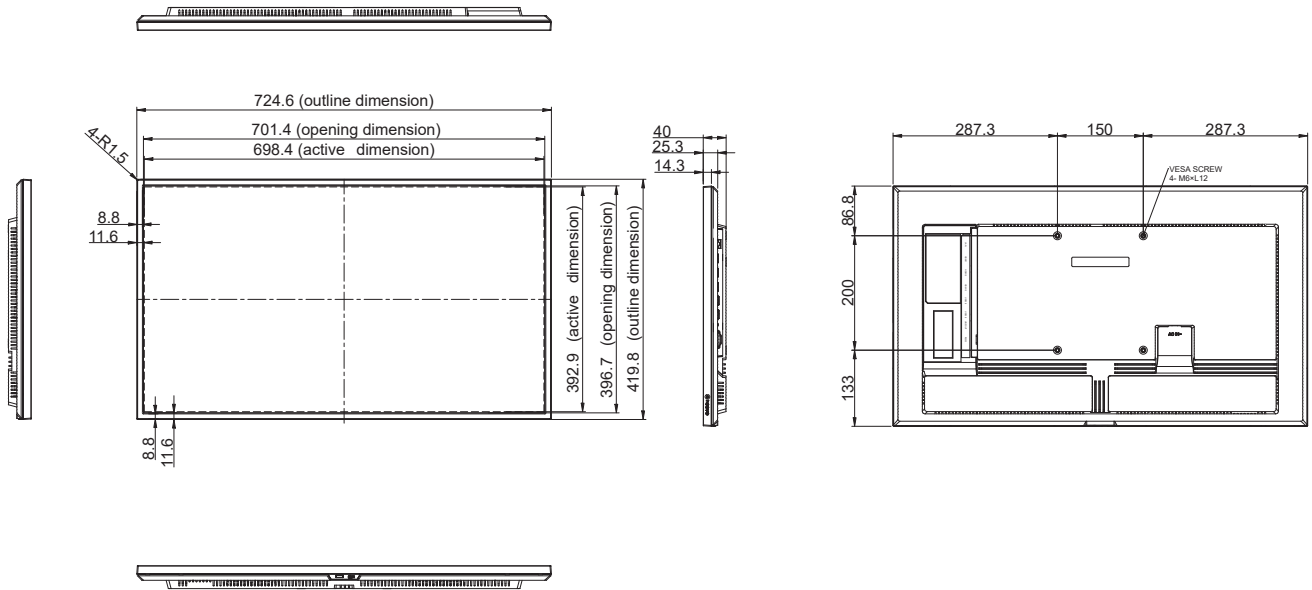

NSD-4303

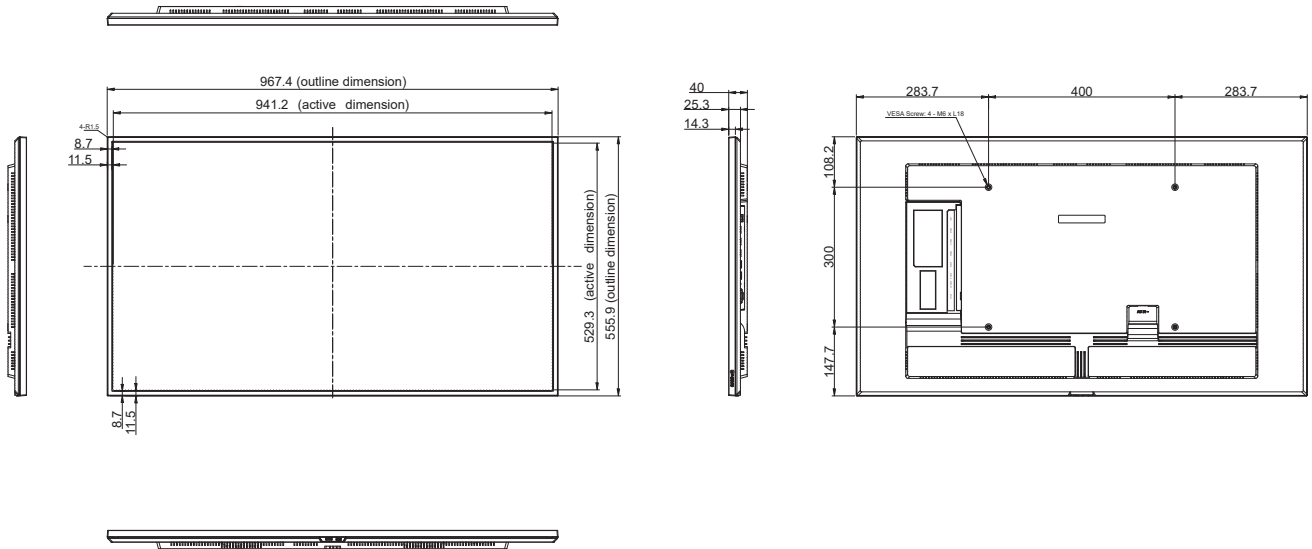

SPECIFICATIONS

NSD-5503

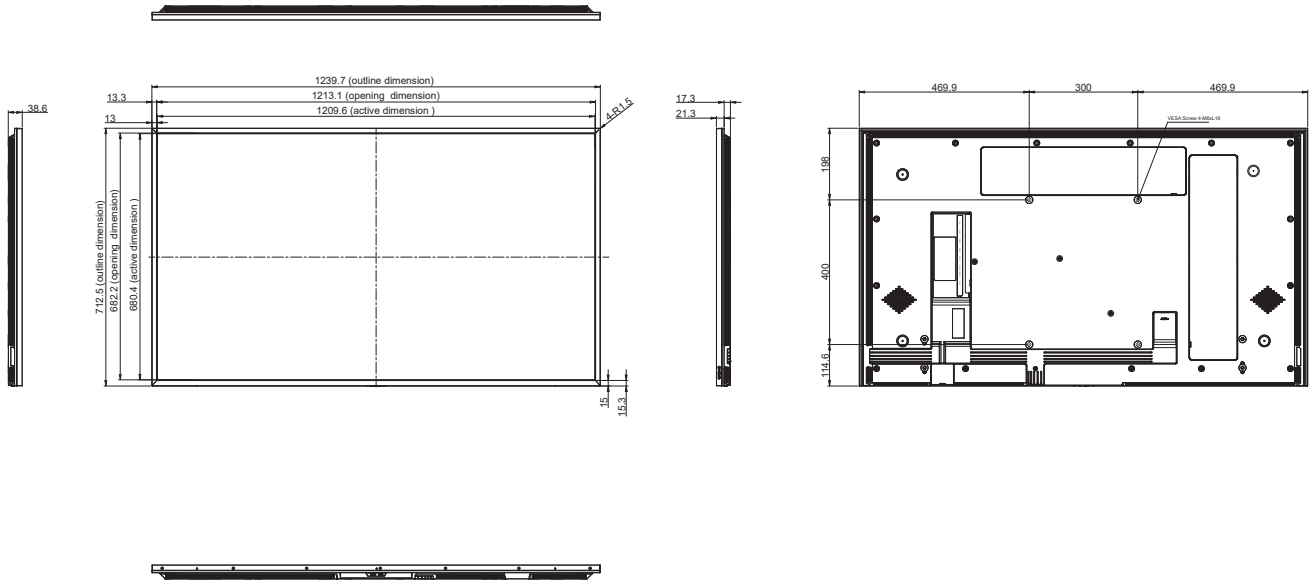

NSD-6503

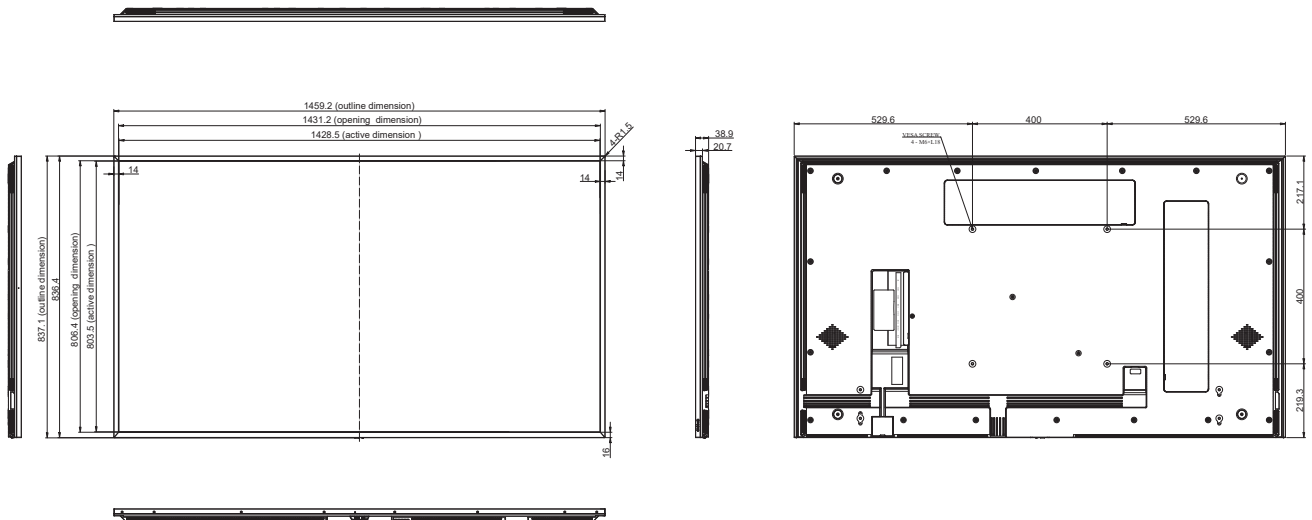

AG Neovo

Company Address: 5F-1, No. 3-1, Park Street, Nangang District, Taipei, 11503, Taiwan.

Copyright © 2025 AG Neovo. All rights reserved.

ND3230/ND4330/ND5530/ND6530_UM_V012