



THE DISPLAY CHOICE
OF PROFESSIONALS™

www.agneovo.com

ME-3201 LCD Display
User Manual

TABLE OF CONTENTS

SAFETY INFORMATION

WEEE.....	3
-----------	---

PRECAUTIONS

Notice	4
Cautions When Setting Up	4
Cautions When Using.....	5
Cleaning and Maintenance.....	6
Notice for the LCD Monitor.....	6

CHAPTER 1: PRODUCT DESCRIPTION

1.1 Package Contents	7
1.2 Installation	8
1.2.1 Installing the Stand.....	8
1.2.2 Adjusting the Viewing Angle and Height.....	9
1.2.3 Wall Mounting.....	9
1.3 Overview	10
1.3.1 Front View	10
1.3.2 Control Buttons.....	11
1.3.3 Rear View.....	13

CHAPTER 2: MAKING CONNECTIONS

2.1 Connecting the AC Power	14
2.2 Connecting Input Source Signals.....	14
2.3 Connecting Audio Devices	15

CHAPTER 3: ON SCREEN DISPLAY MENU

3.1 OSD Menu Tree	16
-------------------------	----

CHAPTER 4: ADJUSTING THE LCD MONITOR

4.1 Colour Setting.....	18
4.2 OSD Setting	19
4.3 Other Setting	20
4.4 Reset Setting.....	21

CHAPTER 5: APPENDIX

5.1 Warning Messages.....	22
5.2 Troubleshooting.....	23

CHAPTER 6: SPECIFICATIONS

6.1 Monitor Specifications	24
6.2 Monitor Dimensions.....	25

SAFETY INFORMATION

Waste Electrical and Electronic Equipment-WEEE

Attention users in European Union private households

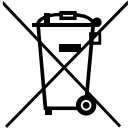

Disposal of Waste Equipment by Users in Private Household in the European Union.

This symbol on the product or on its packaging indicates that this product must not be disposed of with your other household waste. Instead, it is your responsibility to dispose of your waste equipment by handing it over to a designated collection point for the recycling of waste electrical and electronic equipment. The separate collection and recycling of your waste equipment at the time of disposal will help to conserve natural resources and ensure that it is recycled in a manner that protects human health and the environment. For more information about where you can drop off your waste equipment for recycling, please contact your local city office, your household waste disposal service or the shop where you purchased the product.

For Private Households in the European Union. To help conserve natural resources and ensure the product is recycled in a manner that protects human health and the environment, we would like to bring your attention to the following:

- The crossed-out dustbin on the device or outer packaging indicates the product is compliant with European WEEE (Waste Electrical and Electronic Equipment) Directive.
- Always dispose of the old devices separately from household waste.
- Batteries should be removed beforehand and disposed separately to the right collection system.
- You are responsible with regard to the deletion of personal data on old devices before disposal.
- Private households can hand in their old devices free of charge.
- For more information about where you can drop off your waste equipment for recycling, please contact your local city office, your household waste disposal service or the shop where you purchased the product.

PRECAUTIONS

PRECAUTIONS

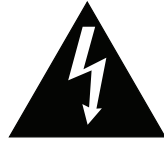

CAUTION
RISK OF ELECTRIC SHOCK
DO NOT OPEN



Symbols used in this manual



This icon indicates the existence of a potential hazard that could result in personal injury or damage to the product.



This icon indicates important operating and servicing information.

Notice

- Read this User Manual carefully before using the LCD monitor and keep it for future reference.
- The product specifications and other information provided in this User Manual are for reference only. All information is subject to change without notice. Updated content can be downloaded from our web site at www.agneovo.com.
- To protect your rights as a consumer, do not remove any stickers from the LCD monitor. Doing so may affect the determination of the warranty period.

Cautions When Setting Up



Do not place the LCD monitor near heat sources, such as a heater, exhaust vent, or in direct sunlight.



Do not cover or block the ventilation holes in the housing.



Place the LCD monitor on a stable area. Do not place the LCD monitor where it may be subject to vibration or shock.



Place the LCD monitor in a well-ventilated area.



Do not place the LCD monitor outdoors.



Do not place the LCD monitor in a dusty or humid environment.



Do not spill liquid or insert sharp objects into the LCD monitor through the ventilation holes. Doing so may cause accidental fire, electric shock or damage the LCD monitor.

PRECAUTIONS

Cautions When Using



Use only the power cord supplied with the LCD monitor.



The power outlet should be installed near the LCD monitor and be easily accessible.



If an extension cord is used with the LCD monitor, ensure that the total current consumption plugged into the power outlet does not exceed the ampere rating.



Do not allow anything to rest on the power cord. Do not place the LCD monitor where the power cord may be stepped on.



If the LCD monitor will not be used for an indefinite period of time, unplug the power cord from the power outlet.



To disconnect the power cord, grasp and pull by the plug head. Do not tug on the cord; doing so may cause fire or electric shock.



Do not unplug or touch the power cord with wet hands.



WARNING:

Unplug the power cord from the power outlet and refer to qualified service personnel under the following conditions:



- When the power cord is damaged.
- If the LCD monitor has been dropped or the housing has been damaged.
- If the LCD monitor emits smoke or a distinct odor.



Ceiling mount or mount on any other horizontal surface overhead are not advisable.



WARNING:

Installation in contravention of the instructions may result in undesirable consequences, particularly hurting people and damaging property. Users who have already mounted the monitor on the ceiling or any other horizontal surface overhead are strongly advised to contact AG Neovo for consultations and solutions to help ensure a most pleasurable and fulfilling monitor experience.

PRECAUTIONS

Cleaning and Maintenance



Do not attempt to service the LCD monitor yourself, refer to qualified service personnel.

Opening or removing the covers may expose you to dangerous voltage or other risks.

Notice for the LCD Monitor

In order to maintain the stable luminous performance, it is recommended to use low brightness setting.

Due to the lifespan of the lamp, it is normal that the brightness quality of the LCD monitor may decrease with time.

When static images are displayed for long periods of time, the image may cause an imprint on the LCD monitor. This is called image retention or burn-in.

To prevent image retention, do any of the following:

- Set the LCD monitor to turn off after a few minutes of being idle.
- Use a screen saver that has moving graphics or a blank white image.
- Switch desktop backgrounds regularly.
- Adjust the LCD monitor to low brightness settings.
- Turn off the LCD monitor when the system is not in use.

Things to do when the LCD monitor shows image retention:

- Turn off the LCD monitor for extended periods of time. It can be several hours or several days.
 - Use a screen saver and run it for extended periods of time.
 - Use a black and white image and run it for extended periods of time.
-

There are millions of micro transistors inside the LCD monitor. It is normal for a few transistors to be damaged and to produce spots. This is acceptable and is not considered a failure.

CHAPTER 1: PRODUCT DESCRIPTION

1.1 Package Contents

When unpacking, check if the following items are included in the package. If any of them is missing or damaged, contact your dealer.

LCD Display

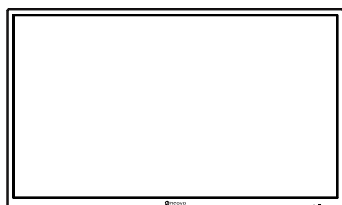

Base

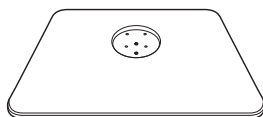

Stand

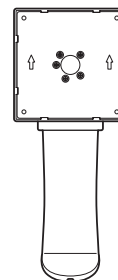

Quick Start Guide



HDMI Cable

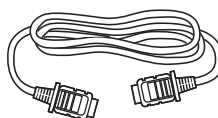

Power Cord

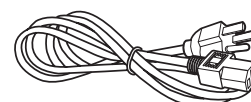

Power Adapter

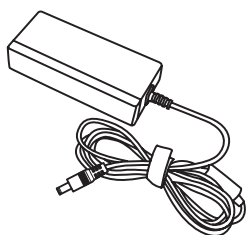

Screws

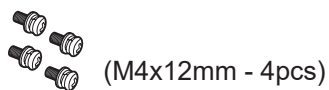
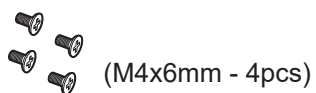

Note:

- Use only the supplied power cord.
- The above pictures are for reference only. Actual items may vary upon shipment.

PRODUCT DESCRIPTION

1.2 Installation

1.2.1 Installing the Stand

1. Place the LCD display with the screen side down on a cushioned surface.
2. Attach the base to the stand and fix with the screws to join them tightly.
3. Attach the base stand to the LCD display and fix with the screws to join them tightly.

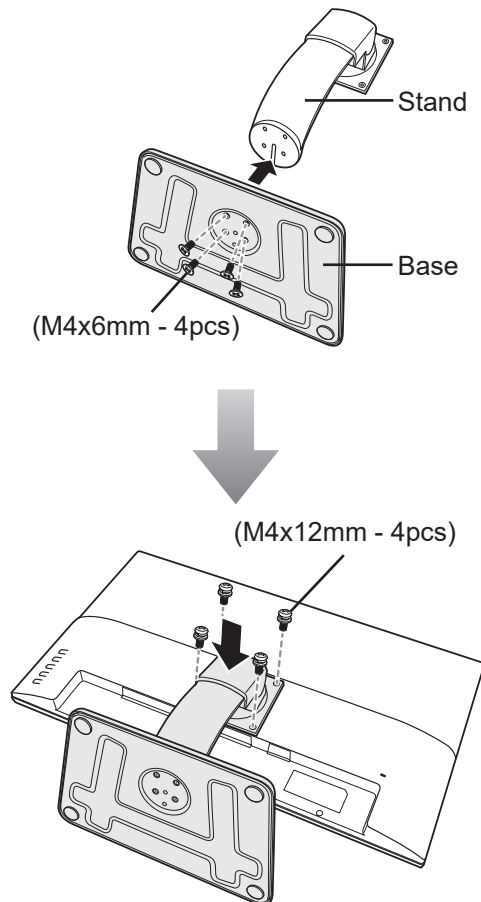

PRODUCT DESCRIPTION

1.2.2 Adjusting the Tilt

For comfort viewing, tilt the LCD display up to an angle of -5° to 15° . Hold the stand with one hand and use the other to adjust the LCD display to the desired angle.

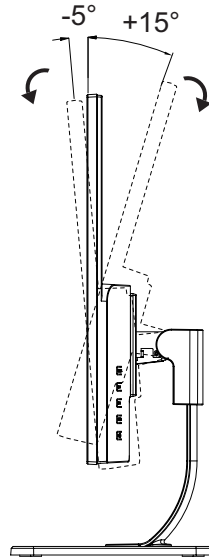

1.2.3 Wall Mounting

To wall mount the LCD display, do the following steps:

1. Remove the base stand.
2. Wall mount the LCD display.

Screw the mounting bracket to the VESA holes at the rear of the LCD display.

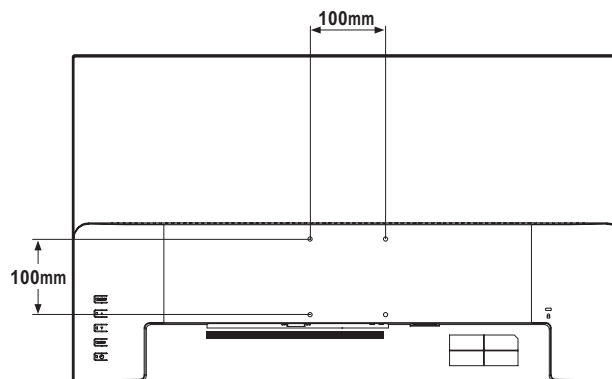

Note: Take measures to prevent the LCD display from falling down and lessen possible injury and damage to the display in case of earthquakes or other disasters.

- Use only the 100 x 100 mm wall mount kit recommended by AG Neovo. All AG Neovo wall mount kits comply with VESA standard.
- Secure the LCD display on a solid wall strong enough to bear its weight.
- It is suggested to wall mount the LCD display without tilting it facing downward.

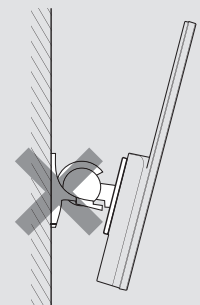

PRODUCT DESCRIPTION

1.3 Overview

1.3.1 Front View

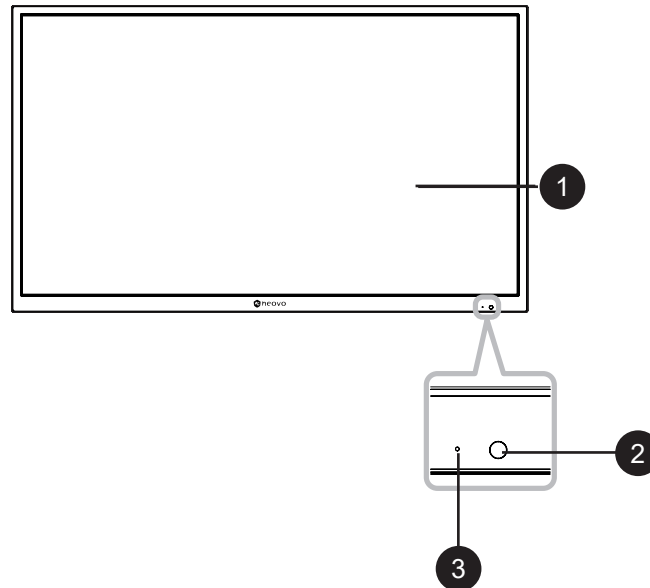

- 1** **Display screen**
- 2** **Remote control sensor:**
Receives command signals from the remote control.
- 3** **Power status indicator:** Indicates the operating status of the display:
 - Lights Blue when the display is turned on.
 - Lights blinking blue when the display is in standby mode.
 - Lights off when the main power of the display is turned off.

PRODUCT DESCRIPTION

1.3.2 Control Buttons

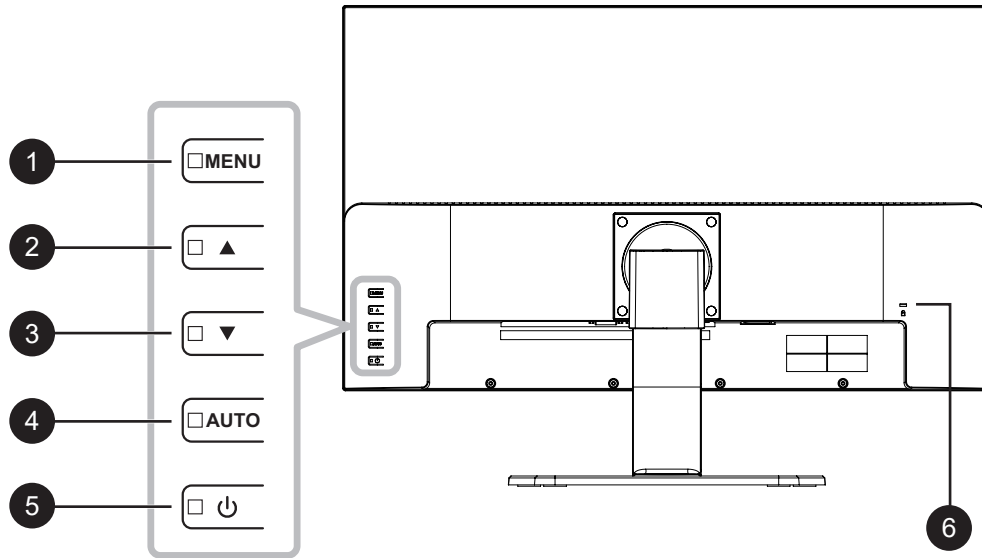

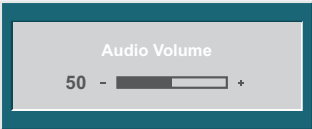
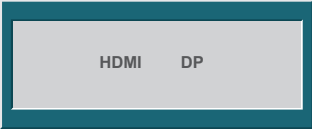
No.	Button	Description
1	Menu Button (MENU)	<p>On Screen Display (OSD)</p> <ul style="list-style-type: none"> Press to call out the OSD menu. <p>During OSD menu</p> <ul style="list-style-type: none"> Use to confirm the selection or enter a submenu.
2 3	Up / Down Button [▲] Up [▼] Down	<p>Volume Bar</p> <ul style="list-style-type: none"> Press the ▲ button to call out the volume bar.  <p>Then press the ▲/▼ button to adjust the volume level.</p> <p>Note: During volume or menu setting adjustment, press and hold the ▲/▼ button to change the values continuously.</p> <p>Input Select Bar</p> <ul style="list-style-type: none"> Press the ▼ button to call out the Input Select bar.  <p>Then press the ▲/▼ button to switch the input source and press the MENU button to confirm.</p> <p>During OSD menu</p> <ul style="list-style-type: none"> Use to scroll through the menu options. Use to select an option and adjust the settings.

PRODUCT DESCRIPTION

No.	Button	Description
4	Auto Button (AUTO)	During OSD menu <ul style="list-style-type: none">• Use to close the OSD menu or exit a submenu. During volume adjustment <ul style="list-style-type: none">• Use to close the volume bar.
5	Power Button (⏻)	Power ON/OFF <ul style="list-style-type: none">• Press once to turn the monitor ON.• Press again to turn the monitor OFF.
6	Kensington security slot: Used for security and theft prevention.	

PRODUCT DESCRIPTION

1.3.3 Rear View

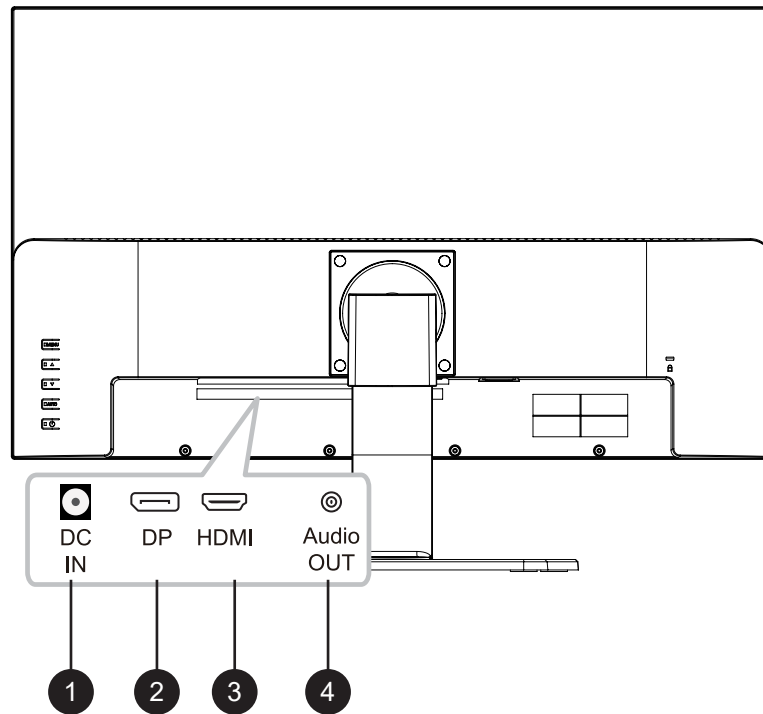

- 1 DC IN**
Connect with the supplied power adaptor.
- 2 DP(DisplayPort)**
Connect DisplayPort signals input.
- 3 HDMI**
Connect HDMI signals input.
- 4 Audio Out**
Connector a audio device (3.5mm Stereo Audio Jack).

CHAPTER 2: MAKING CONNECTIONS



CAUTION:

Make sure that the LCD monitor is not connected to the power outlet before making any connections. Connecting cables while the power is ON may cause possible electric shock or personal injury.

2.1 Connecting the AC Power

1. Connect the power cord to the power adapter.
2. Connect the power adapter to the DC power input at the rear of the LCD monitor.
3. Connect the power cord plug to a power outlet or a power supply.

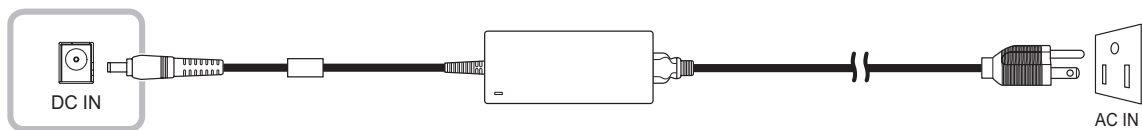

CAUTION:

When unplugging the power cord, hold the power cord by the plug head. Never pull by the cord.

2.2 Connecting Input Source Signals

Input source signals can be connected with either of the following cables:

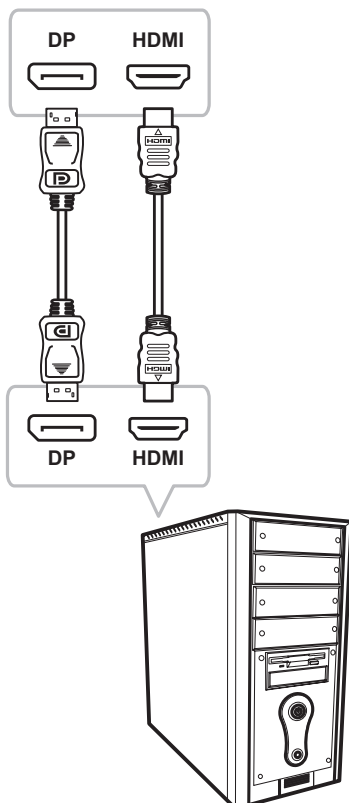

- **DisplayPort**

Connect one end of a DisplayPort cable to the DisplayPort connector of the LCD monitor and the other end to the DisplayPort connector of the computer.

- **HDMI**

Connect one end of an HDMI cable to the HDMI connector of the LCD monitor and the other end to the HDMI connector of the computer.

MAKING CONNECTIONS

2.3 Connecting Audio Devices

- **Audio Out**

Connector a audio device to the audio out jack of the LCD monitor.

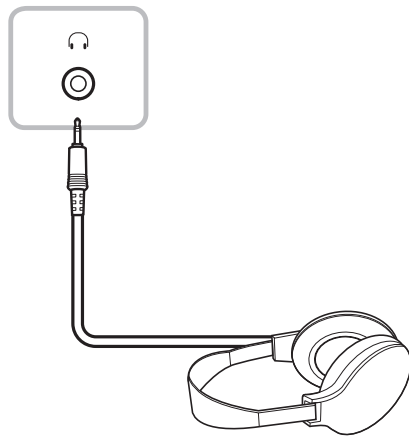

CHAPTER 3: ON SCREEN DISPLAY MENU

3.1 OSD Menu Tree

Main Menu	Submenu		Reference
Colour	Contrast	0-100	Refer to page 18.
	Brightness	0-100	
	Color Temp.	9300	
		6500	
		5500	
USER			
OSD	Language	English	Refer to page 19.
		Français	
		Deutsch	
		Italiano	
		Русский	
		Spanish	
		Portuguese	
		日本語	
		繁體中文	
		简体中文	
	Polski		
	OSD H. Pos.	0-100	
	OSD V. Pos.	0-100	
	OSD Timer	5-100	
Transparency	0-100		

ON SCREEN DISPLAY MENU

3.1 OSD Menu Tree

Main Menu	Submenu		Reference
Other	Mode	PC	Refer to page 20, 21
		VIVID	
		TEXT	
	Audio Volume	0-100	
	Signal Source	AUTO	
		HDMI	
		DP	
	Aspect Ratio	16:9	
		AUTO	
		4:3	
	DCR	On	
		Off	
	Anti Blue Light	0-100	
	Over Drive	On	
		Off	
ANTI-BURN-IN	Enable		
	Interval (Hours)		
Reset	Reset		Refer to page 21.

Note: Availability of some menu items depend on the input source signal. If the menu is not available, it is disabled and greyed out.

CHAPTER 4: ADJUSTING THE LCD MONITOR

4.1 Colour Setting

1. Press the MENU button to call out the OSD window.
2. Press the ▲ or ▼ button to select  and press the MENU button to enter the Colour menu.

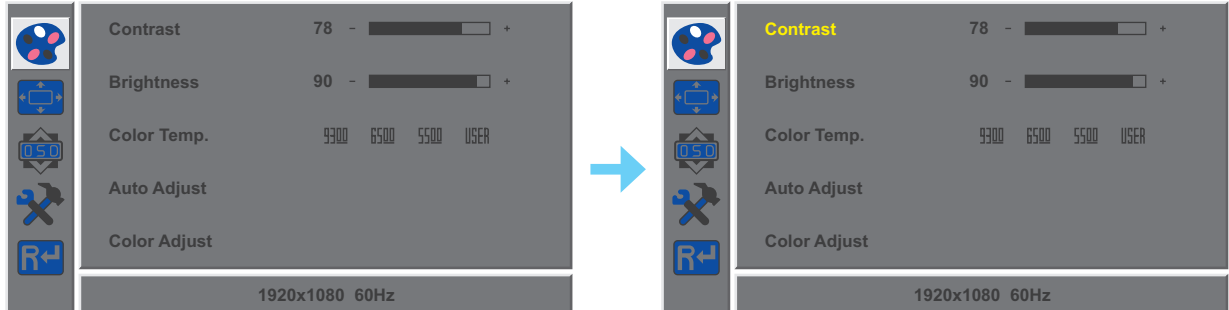

3. Press the ▲ or ▼ button to select an option and press the MENU button to enter its submenu.

Item	Function	Operation	Range
Contrast	Adjusts the difference between the black level and the white level.	Press the ▲ or ▼ button to adjust the value.	0 to 100
Brightness			
Color Temp. (Colour Temperature)	Provides several colour adjustment settings.	Press the ▲ or ▼ button to select the setting.	9300 6500 5500 USER
Colour temperature can be set to: <ul style="list-style-type: none"> • 9300 - Applies a bluish tint for cooler colours. • 6500 - This is the default colour temperature commonly used for normal lighting conditions. • 5500 - Applies a reddish tint for warmer colours. • USER - This allows users to set the colour temperature by adjusting the red, green, or blue setting according to one's preference. <ol style="list-style-type: none"> a. Select USER and press the MENU button. b. Press the ▲ or ▼ button to select the colour you want to adjust. Then press the MENU button to enter its submenu. c. Press the ▲ or ▼ button to adjust the value (0 ~ 255). <p>Note: Activate Reset to return the colour to its default setting.</p>			

ADJUSTING THE LCD MONITOR

4.2 OSD Setting

1. Press the MENU button to call out the OSD window.
2. Press the ▲ or ▼ button to select  and press the MENU button to enter the OSD menu.

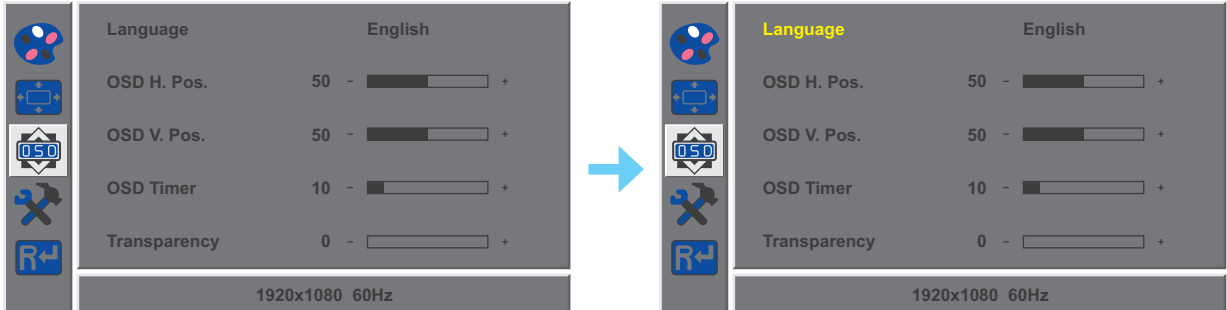

3. Press the ▲ or ▼ button to select an option and press the MENU button to enter its submenu.

Item	Function	Operation	Range
Language	Choose the language used for OSD menus.	Press the ▲ or ▼ button to select the setting.	English Français Deutsch Italiano Русский Spanish Portuguese 日本語 繁體中文 简体中文 Polski
OSD H. Pos. (Horizontal Position)	Moves the OSD window to the left or right of the screen.	Press the ▲ or ▼ button to adjust the value.	0 to 100
OSD V. Pos. (Vertical Position)	Moves the OSD window up or down the screen.		
OSD Timer	Sets the length of time (in seconds) the OSD screen is displayed. When the time elapses, the OSD screen is automatically inactivated.		5 to 60
Transparency	Adjusts the transparency level of the OSD screen.		0 to 100

ADJUSTING THE LCD MONITOR

4.3 Other Setting

1. Press the MENU button to call out the OSD window.
2. Press the ▲ or ▼ button to select  and press the MENU button to enter the Other menu.

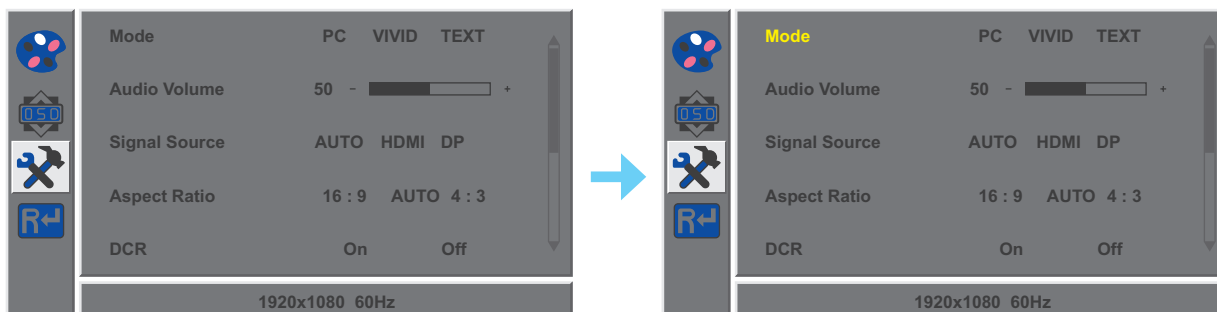

3. Press the ▲ or ► button to select an option and press the MENU button to enter its submenu.

Item	Function	Operation	Range
Mode	Selects the display mode.	Press the ▲ or ▼ button to select the setting.	PC VIVID TEXT
Audio Volume	Adjusts the volume level of the built-in speaker.	Press the ▲ or ▼ button to adjust the value.	0 to 100
Signal Source	Switches the input source.	Press the ▲ or ▼ button to select the setting.	AUTO HDMI DP
Aspect Ratio	Selects the aspect ratio of the screen image.		16:9 AUTO 4:3
DCR	Automatically adjusts the image contrast according to the scene. Note: If this function is On , Colour > Brightness/Contrast are grey out.		On Off
Anti Blue Light	Enables/Disables the blue light filter function. When enabled, it decreases the amount of blue light displayed on the screen, ensuring users a comfortable viewing experience by reducing eyestrain after long periods of use.		0 to 100
Over Drive	Enhance the monitor response time.		On Off

ADJUSTING THE LCD MONITOR

Item	Function	Operation	Range
ANTI-BURN-IN	Enable Enable Anti-Burn-in function to protect the display from “burn-in” or “afterimage” symptoms when the display is not being in use for a period of time.	Press the ▲ or ▼ button to select the setting.	On Off
	Interval (Hours) Selects the interval time (hour) between activating the Anti-Burn-in™ function.		4 5 6 8

4.4 Reset Setting

1. Press the MENU button to call out the OSD window.
2. Press the ▲ or ▼ button to select **R↩** and press the MENU button to enter the Reset menu.

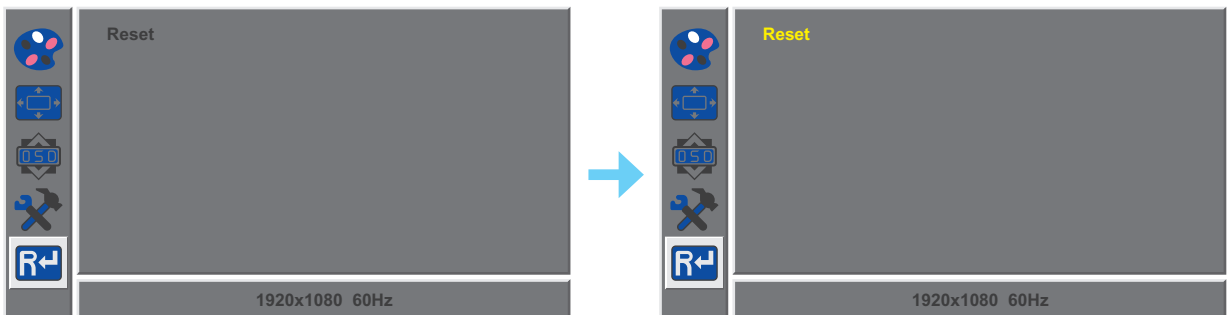



3. Press the MENU button to restore your device to OSD default settings.

CHAPTER 5: APPENDIX

5.1 Warning Messages

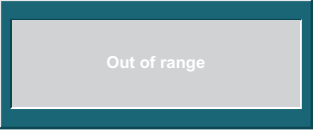
When any of these warning messages appear, check the following items.

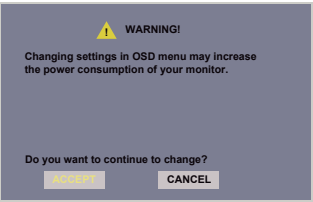
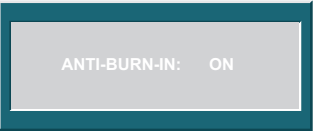
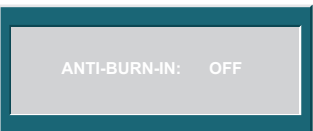
Warning Message	Cause	Solution
	The resolution or the refresh rate of the graphics card of the computer is set too high.	√ Change the resolution or the refresh rate of the graphics card.
	The LCD monitor cannot detect the input source signal.	<ul style="list-style-type: none"> √ Check if the input source is turned ON. √ Check if the signal cable is properly connected. √ Check if any pin inside the cable connector is twisted or broken.
	This warning message box will only show when the menu feature setting is changed for the first time.	<ul style="list-style-type: none"> √ Press the ACCEPT button to continue the setting changes, or press the CANCEL button to disable the setting changes. <p>Note: The operation may vary from different product models.</p>
	The Anti-Burn-In function has been enabled by the user.	√ Disable the Anti-Burn-In function. Refer to page 21.
	The Anti-Burn-In function has been disabled by the user.	√ Enable the Anti-Burn-In function. Refer to page 21.

APPENDIX

5.2 Troubleshooting

Problems	Possible Cause and Solution
No picture. <ul style="list-style-type: none">• LED indicator is OFF.	<ul style="list-style-type: none">• Check if the LCD monitor is turned ON.• Check if the power cord is properly connected to the LCD monitor.• Check if the power cord is plugged into the power outlet.
<ul style="list-style-type: none">• LED indicator is blinking blue.	<ul style="list-style-type: none">• Check if the computer is turned ON.• Check if the computer is in standby mode, move the mouse or press any key to wake up the computer.
Red, blue, green, white dots appear on the screen.	<ul style="list-style-type: none">• There are millions of micro transistors inside the LCD monitor. It is normal for a few transistors to be damaged and to produce spots. This is acceptable and is not considered a failure.
No audio output.	<ul style="list-style-type: none">• Check if the volume is set to 0.• In Other (🔧) menu, check if the Audio Volume setting is set to 0 (refer to page 20).
Dew formed on the LCD monitor.	<ul style="list-style-type: none">• This normally happens when the LCD monitor is moved from a cold room to a hot room temperature. Do not turn ON the LCD monitor, wait for the dew condensation to disappear.
Faint shadows from a static image appear on the screen.	<ul style="list-style-type: none">• Turn off the LCD monitor for extended periods of time.• Use a screen saver or a black and white image and run it for extended periods of time.• Enable Anti-Burn-in function to protect the display from “burn-in” or “afterimage” symptoms when the display is not being in use for a period of time. (refer to page 21).

CHAPTER 6: SPECIFICATIONS

6.1 Monitor Specifications

ME-3201		
Panel	Panel Type	LED-Backlit TFT LCD (VA Technology)
	Panel Size	31.5"
	Max. Resolution	FHD 1920 x 1080
	Pixel Pitch	0.364 mm
	Brightness	300 cd/m ²
	Contrast Ratio	20,000,000 (DCR)
	Viewing Angle (H/V)	178°/178°
	Display Colour	16.7M
	Response Time	5 ms
	Surface Treatment	Anti-Glare Treatment (Haze25%), 3H Hard Coating
Frequency (H/V)	H Freq.	30 kHz-81 kHz
	V Freq.	56 Hz-75 Hz
Input	DisplayPort	x 1
	HDMI	x 1
	Audio Out	Stereo Audio Jack (3.5 mm)
	Internal Speakers	3W x 2
Power	Power Supply	External
	Power Requirements	AC 100-240V, 50-60Hz
	On Mode	26W (On)
	Standby Mode	< 0.5W
	Off Mode	< 0.3W
Operating Conditions	Temperature	5°C-35°C (41°F-95°F)
	Humidity	20%-85% (non-condensing)
Transport/ Storage Conditions	Temperature	-20°C-60°C (-4°F-140°F)
	Humidity	5%-85% (non-condensing)
Mounting	VESA FPMPMI	Yes (100 x 100 mm)
Stand	Tilt	-5° to 15°
Security	Kensington Security Slot	Yes
Dimensions	Product with Base (W x H x D)	728.8 x 540.3 x 236.7 mm (28.7" x 21.3" x 9.3")
	Product w/o Base (W x H x D)	728.8 x 433.1 x 57.4 mm (28.7" x 17.1" x 2.2")
	Packaging (W x H x D)	801.0 x 521.0 x 207.0 mm (31.5" x 20.5" x 8.1")
Weight	Product with Base	8.7 kg (19.2 lb)
	Product w/o Base	5.5 kg (12.1 lb)
	Packaging	10.2 kg (22.5 lb)

Note: All specifications are subject to change without prior notice.

SPECIFICATIONS

6.2 Monitor Dimensions

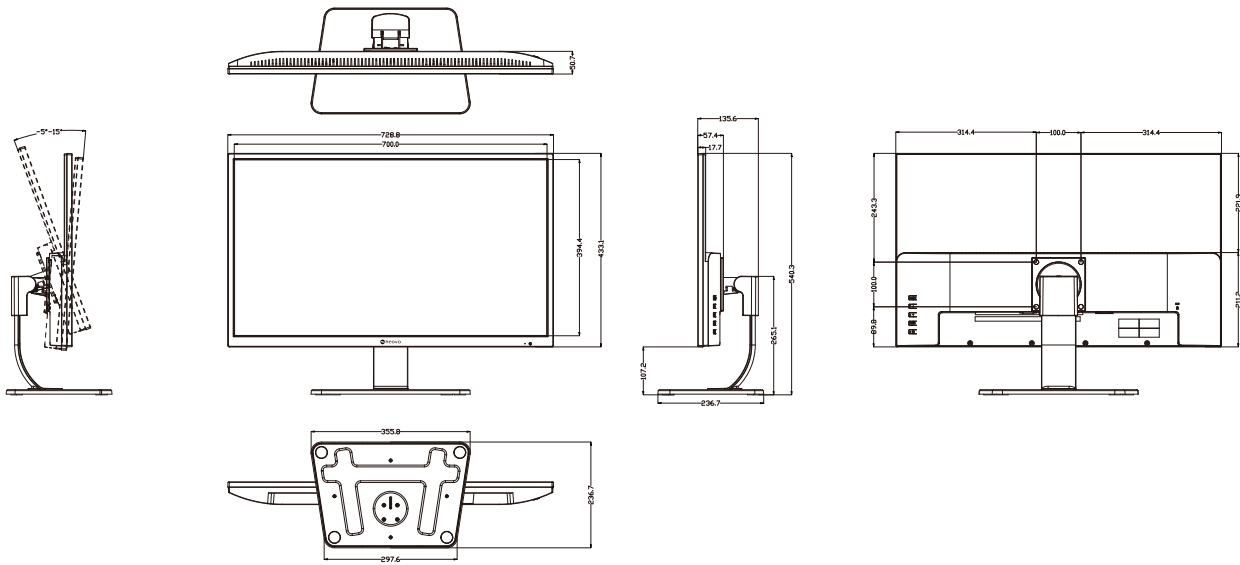

AG Neovo

Company Address: 5F-1, No. 3-1, Park Street, Nangang District, Taipei, 11503, Taiwan.

Copyright © 2024 AG Neovo. All rights reserved.

ME-3201 Eprel registration number: 1943355

ME3210_UM_V010