



THE DISPLAY CHOICE
OF PROFESSIONALS™

IFP6504E-AE 4K UHD Interactive Display

www.agneovo.com

User Manual

TABLE OF CONTENTS

SAFETY INFORMATION	1
Federal Communications Commission (FCC) Notice (U.S. Only).....	1
Polish Center for Testing and Certification Notice	1
Electric, Magnetic and Electromagnetic Fields ("EMF").....	2
Information for U.K. only.....	3
North Europe (Nordic Countries) Information.....	4
End-of-Life Disposal	5
Waste Electrical and Electronic Equipment-WEEE.....	5
Turkey RoHS.....	6
Ukraine RoHS	6
PRECAUTIONS	7
Cautions When Setting Up	7
Cautions When Using.....	8
Cleaning and Maintenance.....	8
Notice for the Interactive Display.....	9
Caring for the Touch Screen.....	9
CHAPTER 1: PRODUCT DESCRIPTION.....	10
1.1 Unpacking	10
1.2 Package Contents	10
1.3 Preparing for the Installation	11
1.4 Wall Mounting Installation.....	11
1.4.1 VESA Grid	12
1.4.2 Mounting the Interactive Display on the Wall.....	12
1.4.3 Ventilation Requirements for Enclosure Locating	14
1.5 Interactive Display Overview	15
1.5.1 Control Panel.....	15
1.5.2 Input/Output Terminals	16
1.6 Remote Control	18
1.6.1 General Functions	18
1.6.2 Inserting the Batteries in the Remote Control	19
1.6.3 Handling the Remote Control	19
1.6.4 Operating Range of the Remote Control.....	20
1.6.5 Motion Sensor	21
CHAPTER 2: MAKING CONNECTIONS.....	22
2.1 Connecting the Power	22
2.2 Connecting a Computer or Portable Device.....	23
2.2.1 Using RS232 Input	23
2.2.2 Using HDMI Input	23
2.2.3 Using the Touch Module	24
2.2.4 Using DisplayPort Input.....	27
2.3 Connecting External Equipment.....	27
2.3.1 Connecting a Video Player	27

TABLE OF CONTENTS

2.3.2	Connecting a Microphone	28
2.3.3	Connecting Audio Equipment	29
2.4	Connecting a Display Device	30
2.5	Connecting to a Wired Network.....	31
2.6	Connecting USB Interface Devices	31
2.7	Connecting a MicroSD Card.....	32
2.8	Attaching Touch Pens	32
2.9	Attaching an OPS	33
CHAPTER 3:	USING THE INTERACTIVE DISPLAY	34
3.1	Turning on the Power	34
3.1.1	Initial Setup.....	34
3.1.2	Powering Off.....	35
3.2	Selecting the Input Source Signal	35
3.3	Muting the Sound	36
3.4	Adjusting the Volume.....	37
3.5	Android Functions.....	38
3.5.1	Accessing the Home Screen	38
3.5.2	Accessing the Slide Menu	38
3.5.3	Returning to the Previous Screen	39
3.5.4	Accessing the File Manager	39
3.5.5	Accessing the Settings Menu	40
3.5.6	Accessing the Whiteboard.....	40
3.5.7	Adding a Bluetooth Device	41
3.6	Using the Touchscreen.....	42
3.7	Using the On-Screen Keyboard	46
CHAPTER 4:	USING THE SYSTEM.....	47
4.1	About the Home Screen	47
4.2	Using the Slide Menu	48
4.3	Configuring System Settings	51
CHAPTER 5:	USING THE APPS	59
5.1	Accessing Apps	59
5.2	Whiteboard	59
5.3	Montage	63
5.4	File Manager	66
5.5	Annotation	67
5.6	ScreenShot.....	68
CHAPTER 6:	APPENDIX.....	69
6.1	Warning Messages.....	69
6.2	Supported Media Formats.....	69
6.3	Supported Resolution.....	71
6.4	Troubleshooting.....	72
6.5	Transporting the Interactive Display	73

TABLE OF CONTENTS

CHAPTER 7: SPECIFICATIONS	74
7.1 Display Specifications	74
7.2 Display Dimensions	75

SAFETY INFORMATION

Federal Communications Commission (FCC) Notice (U.S. Only)



This equipment has been tested and found to comply with the limits for a Class B digital device, pursuant to part 15 of the FCC Rules. These limits are designed to provide reasonable protection against harmful interference in a residential installation. This equipment generates, uses and can radiate radio frequency energy and, if not installed and used in accordance with the instructions, may cause harmful interference to radio communications. However, there is no guarantee that interference will not occur in a particular installation. If this equipment does cause harmful interference to radio or television reception, which can be determined by turning the equipment off and on, the user is encouraged to try to correct the interference by one or more of the following measures:

- Reorient or relocate the receiving antenna.
- Increase the separation between the equipment and receiver.
- Connect the equipment into an outlet on a circuit different from that to which the receiver is connected.
- Consult the dealer or an experienced radio/TV technician for help.



Changes or modifications not expressly approved by the party responsible for compliance could void the user's authority to operate the equipment.

Use only an RF shielded cable that was supplied with the display when connecting this display to a computer device.

To prevent damage which may result in fire or shock hazard, do not expose this appliance to rain or excessive moisture.

THIS CLASS B DIGITAL APPARATUS MEETS ALL REQUIREMENTS OF THE CANADIAN INTERFERENCE-CAUSING EQUIPMENT REGULATIONS.



This device complies with Part 15 of the FCC Rules. Operation is subject to the following two conditions: (1) this device may not cause harmful interference, and (2) this device must accept any interference received, including interference that may cause undesired operation.

Polish Center for Testing and Certification Notice

The equipment should draw power from a socket with an attached protection circuit (a three-prong socket). All equipment that works together (computer, display, printer, and so on) should have the same power supply source.

The phasing conductor of the room's electrical installation should have a reserve short-circuit protection device in the form of a fuse with a nominal value no larger than 16 amperes (A).

To completely switch off the equipment, the power supply cable must be removed from the power supply socket, which should be located near the equipment and easily accessible.

A protection mark "B" confirms that the equipment is in compliance with the protection usage requirements of standards PN-93/T-42107 and PN-89/E-06251.

SAFETY INFORMATION

Wymagania Polskiego Centrum Badań i Certyfikacji

Urządzenie powinno być zasilane z gniazda z przyłączonym obwodem ochronnym (gniazdo z kołkiem). Współpracujące ze sobą urządzenia (komputer, monitor, drukarka) powinny być zasilane z tego samego źródła.

Instalacja elektryczna pomieszczenia powinna zawierać w przewodzie fazowym rezerwową ochronę przed zwarciami, w postaci bezpiecznika o wartości znamionowej nie większej niż 16A (amperów).

W celu całkowitego wyłączenia urządzenia z sieci zasilania, należy wyjąć wtyczkę kabla zasilającego z gniazdka, które powinno znajdować się w pobliżu urządzenia i być łatwo dostępne.

Znak bezpieczeństwa "B" potwierdza zgodność urządzenia z wymaganiami bezpieczeństwa użytkownika zawartymi w PN-93/T-42107 i PN-89/E-06251.

Pozostałe instrukcje bezpieczeństwa

- Nie należy używać wtyczek adapterowych lub usuwać kołka obwodu ochronnego z wtyczki. Jeżeli konieczne jest użycie przedłużacza to należy użyć przedłużacza 3-żyłowego z prawidłowo połączonym przewodem ochronnym.
- System komputerowy należy zabezpieczyć przed nagłymi, chwilowymi wzrostami lub spadkami napięcia, używając eliminatora przepięć, urządzenia dopasowującego lub bezzakłócenowego źródła zasilania.
- Należy upewnić się, aby nic nie leżało na kablach systemu komputerowego, oraz aby kable nie były umieszczone w miejscu, gdzie można byłoby na nie nadeptywać lub potykać się o nie.
- Nie należy rozlewać napojów ani innych płynów na system komputerowy.
- Nie należy wpychać żadnych przedmiotów do otworów systemu komputerowego, gdyż może to spowodować pożar lub porażenie prądem, poprzez zwarcie elementów wewnętrznych.
- System komputerowy powinien znajdować się z dala od grzejników i źródeł ciepła. Ponadto, nie należy blokować otworów wentylacyjnych. Należy unikać kładzenia luźnych papierów pod komputer oraz umieszczania komputera w ciasnym miejscu bez możliwości cyrkulacji powietrza wokół niego.

Electric, Magnetic and Electromagnetic Fields ("EMF")

- We manufacture and sell many products targeted at consumers, which, like any electronic apparatus, in general have the ability to emit and receive electromagnetic signals.
- One of our leading Business Principles is to take all necessary health and safety measures for our products, to comply with all applicable legal requirements and to stay well within the EMF standards applicable at the time of producing the products.
- We are committed to develop, produce and market products that cause no adverse health effects.
- We confirm that if its products are handled properly for their intended use, they are safe to use according to scientific evidence available today.
- We play an active role in the development of international EMF and safety standards, enabling us to anticipate further developments in standardization for early integration in its products.

SAFETY INFORMATION

Information for U.K. only

WARNING - THIS APPLIANCE MUST BE EARTHED.

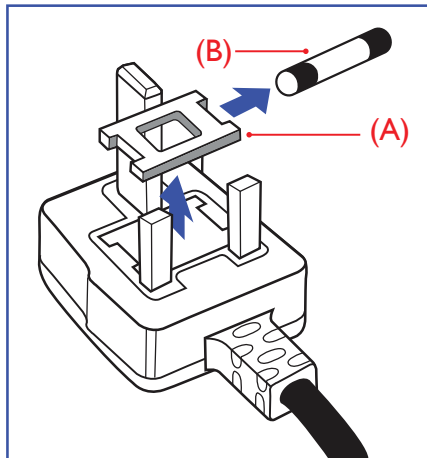

Important:

This apparatus is supplied with an approved moulded 13A plug. To change a fuse in this type of plug proceed as follows:

- 1 Remove fuse cover and fuse.
- 2 Fit new fuse which should be a BS 1362 5A, A.S.T.A. or BSI approved type.
- 3 Refit the fuse cover.

If the fitted plug is not suitable for your socket outlets, it should be cut off and an appropriate 3-pin plug fitted in its place.

If the mains plug contains a fuse, this should have a value of 5A. If a plug without a fuse is used, the fuse at the distribution board should not be greater than 5A.



Note:

The severed plug must be destroyed to avoid a possible shock hazard should it be inserted into a 13A socket elsewhere.

SAFETY INFORMATION

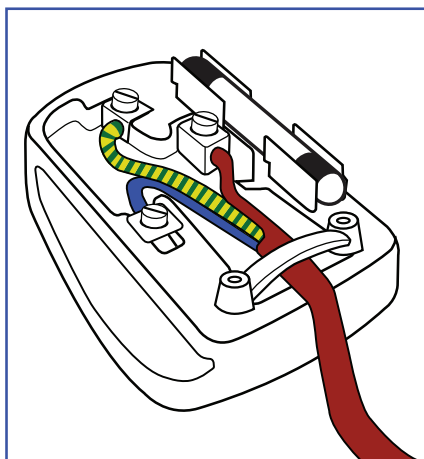

How to connect a plug

The wires in the mains lead are colored in accordance with the following code:

BLUE - "NEUTRAL" ("N")

BROWN - "LIVE" ("L")

GREEN & YELLOW - "EARTH" ("E")

- The GREEN & YELLOW wire must be connected to the terminal in the plug which is marked with the letter "E" or by the Earth symbol or colored GREEN or GREEN & YELLOW.
- The BLUE wire must be connected to the terminal which is marked with the letter "N" or colored BLACK.
- The BROWN wire must be connected to the terminal which marked with the letter "L" or colored RED.

Before replacing the plug cover, make certain that the cord grip is clamped over the sheath of the lead - not simply over the three wires.

North Europe (Nordic Countries) Information

Placering/Ventilation

VARNING: FÖRSÄKRA DIG OM ATT HUVUDBRYTARE OCH UTTAG ÄR LÄTÄTKOMLIGA, NÄR DU STÄLLER DIN UTRUSTNING PÅPLATS.

Placering/Ventilation

ADVARSEL: SØRG VED PLACERINGEN FOR, AT NETLEDNINGENS STIK OG STIKKONTAKT ER NEMT TILGÆNDELIGE.

Paikka/Ilmankierto

VAROITUS: SIJOITA LAITE SITEN, ETTÄ VERKKOJOHTO VOIDAAN TARVITTAESSA HELPOSTI IRROTTAA PISTORASIESTA.

Plassering/Ventilasjon

ADVARSEL: NÅR DETTE UTSTYRET PLASSERES, MÅ DU PASSE PÅ AT KONTAKTENE FOR STØMTILFØRSEL ER LETTE Å NÅ.

SAFETY INFORMATION

End-of-Life Disposal

Your new Public Information Display contains materials that can be recycled and reused. Specialized companies can recycle your product to increase the amount of reusable materials and to minimize the amount to be disposed of.

Please find out about the local regulations on how to dispose of your old display from your local dealer.

(For customers in Canada and U.S.A.)

This product may contain lead and/or mercury. Dispose of in accordance to local-state and federal regulations. For additional information on recycling contact www.eia.org (Consumer Education Initiative).

Waste Electrical and Electronic Equipment-WEEE

Attention users in European Union private households

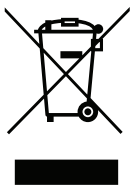

This marking on the product or on its packaging illustrates that, under European Directive 2012/19/EU governing used electrical and electronic appliances, this product may not be disposed of with normal household waste. You are responsible for disposal of this equipment through a designated waste electrical and electronic equipment collection. To determine the locations for dropping off such waste electrical and electronic, contact your local government office, the waste disposal organization that serves your household or the store at which you purchased the product.

Attention users in United States:

Please dispose of according to all Local, State and Federal Laws. For the disposal or recycling information, contact: www.mygreenelectronics.com or www.eiae.org.

End of Life Directives-Recycling



Your new Public Information Display contains several materials that can be recycled for new users.

Please dispose of according to all Local, State, and Federal laws.

Restriction on Hazardous Substances statement (India)

This product complies with the "India E-waste Rule 2011" and prohibits use of lead, mercury, hexavalent chromium, polybrominated biphenyls or polybrominated diphenyl ethers in concentrations exceeding 0.1 weight % and 0.01 weight % for cadmium, except for the exemptions set in Schedule 2 of the Rule.

E-Waste Declaration for India



This symbol on the product or on its packaging indicates that this product must not be disposed of with your other household waste. Instead it is your responsibility to dispose of your waste equipment by handing it over to a designated collection point for the recycling of waste electrical and electronic equipment. The separate collection and recycling of your waste equipment at the time of disposal will help to conserve natural resources and ensure that it is recycled in a manner that protects human health and the environment.

SAFETY INFORMATION

Batteries



For EU: The crossed-out wheeled bin implies that used batteries should not be put to the general household waste! There is a separate collection system for used batteries, to allow proper treatment and recycling in accordance with legislation.

Please contact your local authority for details on the collection and recycling schemes.

For Switzerland: The used battery is to be returned to the selling point.

For other non-EU countries: Please contact your local authority for correct method of disposal of the used battery.

According to EU directive 2006/66/EC, the battery can't be disposed improperly. The battery shall be separated to collect by local service.

Turkey RoHS

Türkiye Cumhuriyeti: EEE Yönetmeliğine Uygundur.

Ukraine RoHS

Обладнання відповідає вимогам Технічного регламенту щодо обмеження використання деяких небезпечних речовин в електричному та електронному обладнанні, затвердженого постановою Кабінету Міністрів України від 3 грудня 2008 № 1057.

PRECAUTIONS

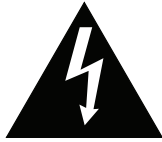

Symbols used in this manual

	This icon indicates the existence of a potential hazard that could result in personal injury or damage to the product.
	This icon indicates important operating and servicing information.

Notice

- Read this User Manual carefully before using the interactive display and keep it for future reference.
- The product specifications and other information provided in this User Manual are for reference only. All information is subject to change without notice. Updated content can be downloaded from our web site at www.agneovo.com.
- To protect your rights as a consumer, do not remove any stickers from the interactive display. Doing so may affect the determination of the warranty period.

Cautions When Setting Up

- Do not place the interactive display near heat sources, such as a heater, exhaust vent, or in direct sunlight.
- Do not cover or block the ventilation holes in the housing.
- Place the interactive display on a stable area. Do not place the interactive display where it may subject to vibration or shock.
- Place the interactive display in a well-ventilated area.
- Do not place the interactive display outdoors.
- To avoid the risk of shock or permanent damage to the set, do not expose the display to dust, rain, water or an excessively moist environment.
- Do not spill liquid or insert sharp objects into the interactive display through the ventilation holes. Doing so may cause accidental fire, electric shock or damage the interactive display.

PRECAUTIONS

Cautions When Using

- Use only the power cord supplied with the interactive display.
- The power outlet should be installed near the interactive display and be easily accessible.
- If an extension cord is used with the interactive display, ensure that the total current consumption plugged into the power outlet does not exceed the ampere rating.
- Do not allow anything to rest on the power cord. Do not place the interactive display where the power cord may be stepped on.
- If the interactive display will not be used for an indefinite period of time, unplug the power cord from the power outlet.
- To disconnect the power cord, grasp and pull by the plug head. Do not tug on the cord; doing so may cause fire or electric shock.
- Do not unplug or touch the power cord with wet hands.
- When turning off the display by detaching the power cord, wait 6 seconds before re-attaching the power cord for normal operation.
- Do not knock or drop the display during operation or transportation.

Cleaning and Maintenance

- To protect your display from possible damage, do not put excessive pressure on the LCD panel. When moving your display, grasp the frame to lift; do not lift the display by placing your hand or fingers on the LCD panel.
- For cleaning the touch screen, refer to page 9.
- If your display becomes wet, wipe it with dry cloth as soon as possible.
- If a foreign substance or water gets in your display, turn the power off immediately and disconnect the power cord. Then remove the foreign substance or water, and send the unit to the maintenance center.
- In order to maintain the best performance of your display and ensure a longer lifetime, we strongly recommend using the display in a location that falls within the following temperature and humidity ranges.
 - ◆ Temperature: 0°C-40°C (32°F-104°F)
 - ◆ Humidity: 10%-90% (non-condensing)



Warning:



Unplug the power cord from the power outlet and refer to qualified service

personnel under the following conditions:

- ◆ When the power cord is damaged.
- ◆ If the interactive display has been dropped or the housing has been damaged.
- ◆ If the interactive display emits smoke or a distinct odor.

PRECAUTIONS

Notice for the Interactive Display

- In order to maintain the stable luminous performance, it is recommended to use low brightness setting.
- Due to the lifespan of the lamp, it is normal that the brightness quality of the interactive display may decrease with time.
- When static images are displayed for long periods of time, the image may cause an imprint on the interactive display. This is called image retention or burn-in.
 - ◆ To prevent image retention, do any of the following:
 - Set the interactive display to turn off after a few minutes of being idle.
 - Use a screen saver that has moving graphics or a blank white image.
 - Switch desktop backgrounds regularly.
 - Adjust the interactive display to low brightness settings.
 - Turn off the interactive display when the system is not in use.
 - ◆ Things to do when the interactive display shows image retention:
 - Turn off the interactive display for extended periods of time. It can be several hours or several days.
 - Use a screen saver and run it for extended periods of time.
 - Use a black and white image and run it for extended periods of time.
- There are millions of micro transistors inside the interactive display. It is normal for a few transistors to be damaged and to produce spots. This is acceptable and is not considered a failure.
- **IMPORTANT:** Always activate a moving screen saver program when you leave your display unattended. Always activate a periodic screen refresh application if the unit will display unchanging static content. Uninterrupted display of still or static images over an extended period may cause “burn in”, also known as “after-imaging” or “ghost imaging”, on your screen. This is a well-known phenomenon in LCD panel technology. In most cases, the “burned in” or “after-imaging” or “ghost imaging” will disappear gradually over a period of time after the power has been switched off.
- **WARNING:** Severe “burn-in” or “after-image” or “ghost image” symptoms will not disappear and cannot be repaired. This is also not covered under the terms of your warranty.

Caring for the Touch Screen

Use the following recommendations to care for the touch screen.

- Before cleaning the screen, make sure the interactive display is switched off and the power cord is unplugged from the wall outlet.
- Remove dirt or dust from the screen regularly. It is recommended to use a small amount of alcohol as cleaning agent.
- To avoid damage to the screen, never use any aggressive solvents or scrubbing agents.
- Wipe the screen gently using a lint-free cloth moistened in the cleaning agent.
- Never spray the cleaning agent on the screen surface or the body directly as it may cause short circuit to the touch screen.
- Do not expose the display to direct sunlight or strong light source during use.

CHAPTER 1: PRODUCT DESCRIPTION

1.1 Unpacking

- This product is packed in a packaging box which contains standard accessories.
- Any other optional accessories will be packed separately.
- Considering the size and weight of the display, it is recommended that this product is carried out by two persons.
- After opening the packaging box, ensure that the included items are in good condition and complete.

1.2 Package Contents

When unpacking, check if the following items are included in the package. If any of them is missing or damaged, contact your dealer.

Interactive Display



Remote Control & AAA Batteries x 2

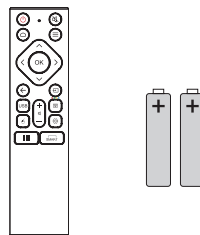

Quick Start Guide



Warning Card & Message

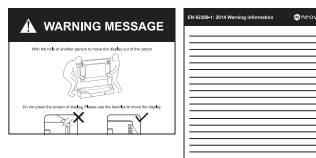

USB Cable (for touch control)

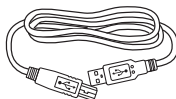

HDMI Cable (1.8M)

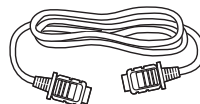

USB-C Cable (1.8M)

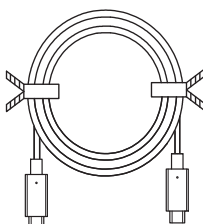

Power Cord (3M)

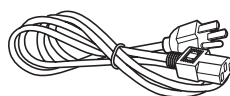

Touch Pen x 2

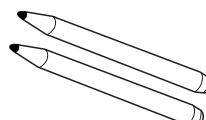

Note:

- ◆ Remote control is shipped with the supplied AAA batteries.
- ◆ For all other regions, apply a power cord that conforms to the AC voltage of the power socket and has been approved by and complies with the safety regulations of the particular country (Type H05W-F, 2G or 3G, 0.75 or 1 mm² should be used).
- ◆ You might like to save the package box and packing material for shipping the display.
- ◆ The pictures are for reference only. Actual items may vary upon shipment.

PRODUCT DESCRIPTION

Wall Mount

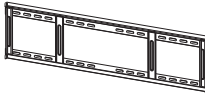

Wall Mount Screw Package

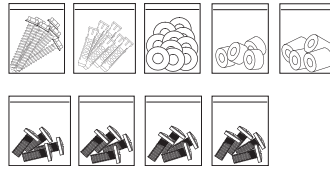

1.3 Preparing for the Installation

- Due to the high power consumption, always use the plug exclusively designed for this product. If an extended line is required, please consult your service agent.
- The product should be installed on a flat surface to avoid tipping. The distance between the back of the product and the wall should be maintained for proper ventilation. Avoid installing the product in the kitchen, bathroom or any other places with high humidity so as not to shorten the service life of the electronic components.
- The product can normally operate only under 3600m in altitude. In installations at altitudes above 3600m, some abnormalities may be experienced.

1.4 Wall Mounting Installation

To mount this display to a wall, you will have to obtain a standard wall-mounting kit (commercially available). We recommend using a mounting interface that complies with TUV-GS and/or UL1678 standard in North America.

To wall-mount the interactive display, screw the mounting bracket to the VESA holes at the rear of the interactive display.

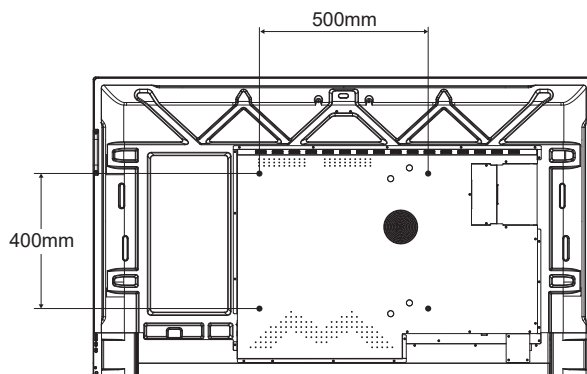

Warning:

- ◆ Do not press too hard on the LCD panel or edge of the frame, as this may cause the device to malfunction.

Note:

- ◆ Avoid the wall-mounting kit to block the ventilation holes on the back of the display.
- ◆ Secure the interactive display on a solid wall strong enough to bear its weight.
- ◆ Lay a protective sheet on a table, which was wrapped around the display when it was packaged, beneath the screen surface so as not to scratch the screen face.
- ◆ Ensure you have all accessories for mounting this display (wall mount, ceiling mount, etc).
- ◆ Follow the instructions that come with the base mounting kit. Failure to follow correct mounting procedures could result in damage to the equipment or injury to the user or installer. Product warranty does not cover damage caused by improper installation.

PRODUCT DESCRIPTION

1.4.1 VESA Grid

Model Name	VESA Grid
IFP6504E-AE	500(W) x 400(H)mm

Caution:

To prevent the display from falling:

- ◆ For wall or ceiling installation, we recommend installing the display with metal brackets which are commercially available. For detailed installation instructions, see the guide received with the respective bracket.
- ◆ To lessen the probability of injury and damage resulting from fall of the display in case of earthquake or other natural disaster, be sure to consult the bracket manufacturer for installation location.

1.4.2 Mounting the Interactive Display on the Wall

To mount the interactive display on the wall, you need the following items:

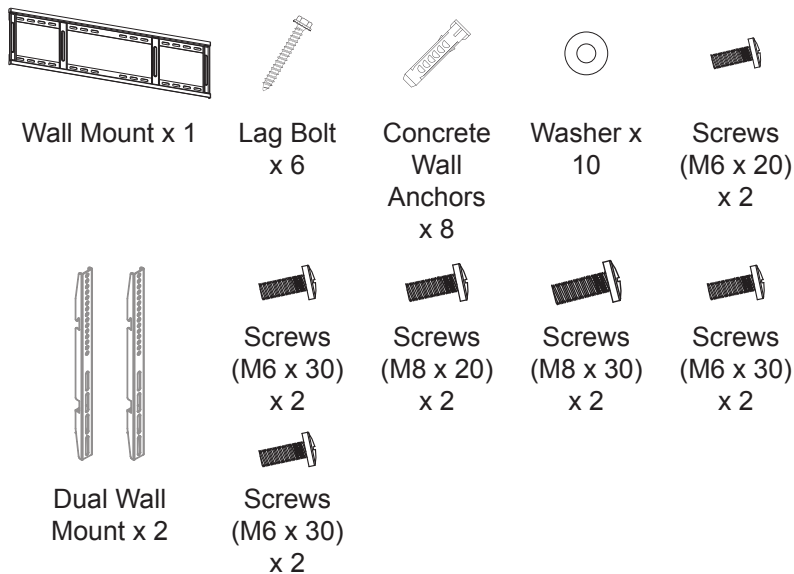

Note:

- ◆ For the wall-mounting kit, use M6 mounting screws (having a length 10 mm longer than the thickness of the mounting bracket) and tighten them securely.
- ◆ Unit without base weight: 38.1 kg.
The equipment and its associated mounting means still remain secure during the test. For use only with UL Listed Wall Mount Bracket with minimum weight/load: 80 kg.

PRODUCT DESCRIPTION

- 1 Keep the wall mount bracket level and mark the four wall mount screw hole locations on the wall.

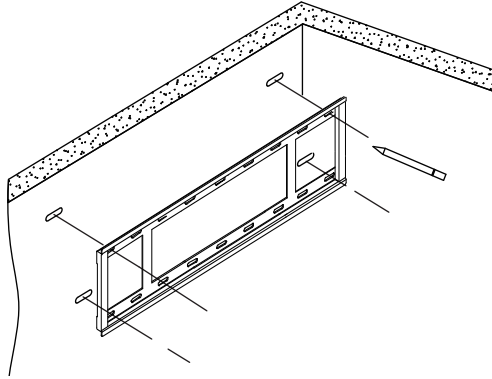

- 2 Drill four small holes on the mounting location with the length and width 50mm x 10mm for concrete wall or 50mm x 5.5mm for stud wall.

Concrete Wall

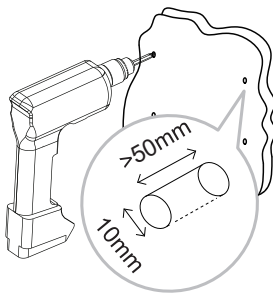

Stud Wall

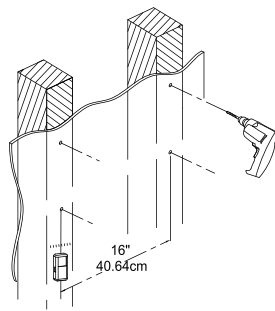

- 3 Insert a wall anchor into each hole.
- 4 Secure the wall mount with the six supplied screws through the washers into the six installed anchors on the wall.

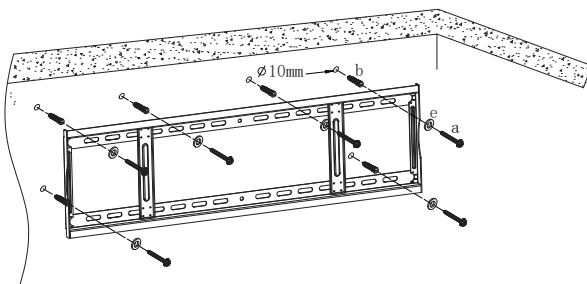

PRODUCT DESCRIPTION

- 5 Secure the dual wall mount with the four supplied bolts through the washers on the wall interactive display.

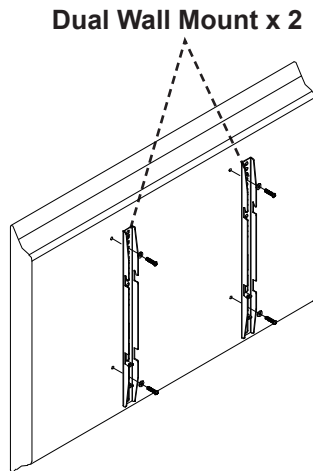

- 6 Align and hook the dual wall mount on the interactive display to the wall mount. Tighten the bolts to secure the interactive display to the wall mount.

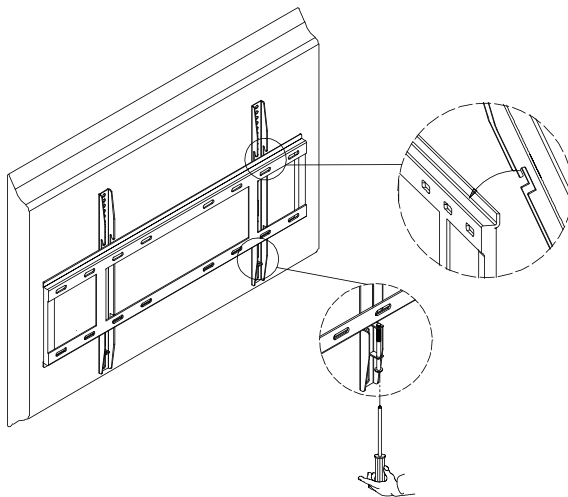

1.4.3 Ventilation Requirements for Enclosure Locating

To allow heat to disperse, leave space between surrounding objects as shown in the diagram below.

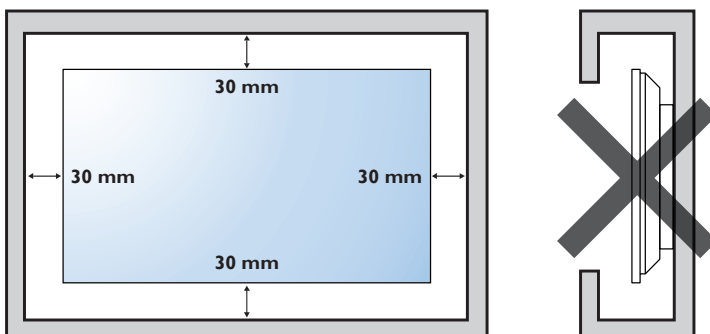

Note:

- ◆ Keep clearances around the interactive display according to the minimum dimensions as illustrated.
- ◆ Never cover the ventilation holes or insert anything into the housing.
- ◆ Do not place the interactive display in a confined space, such as a cabinet or imbedded closet. Place the display on a sturdy, level surface and make sure an appropriate ventilation is provided.



Warning:

- ◆ Please choose the correct bolts and washers suitable for your interactive display. Using incorrect bolts may damage your interactive display.
- ◆ Make sure the power cord of the interactive display is disconnected before the installation.

PRODUCT DESCRIPTION

1.5 Interactive Display Overview

1.5.1 Control Panel

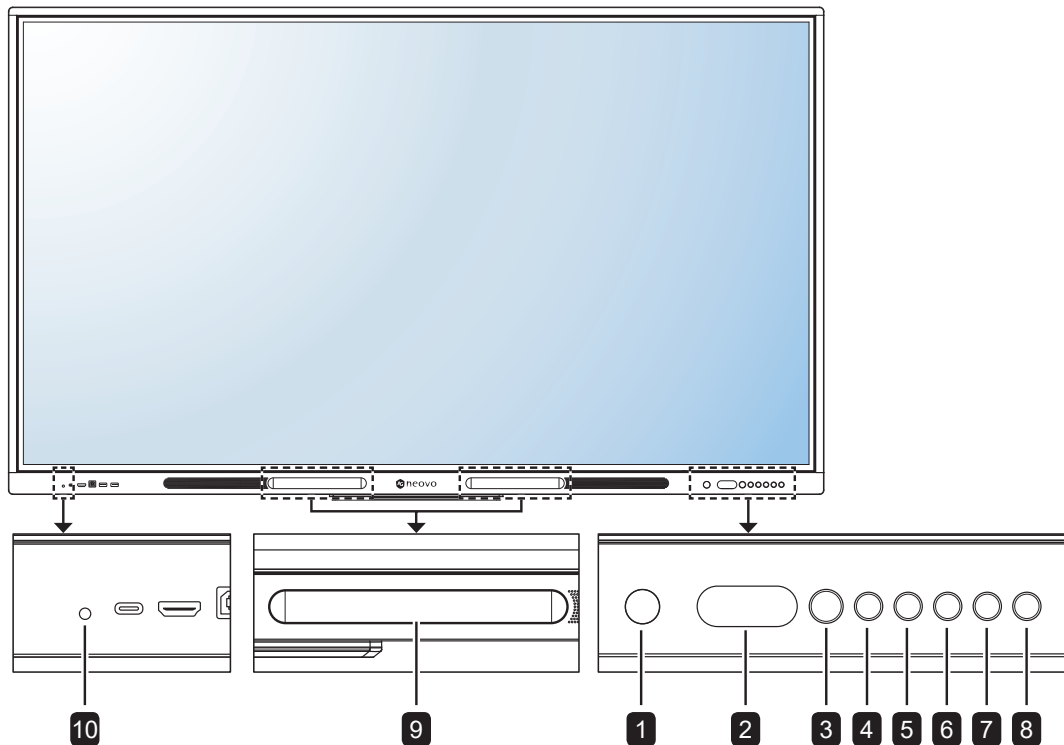

- 1 Motion sensor**
Detects a person approaching.
- 2 Remote control sensor and LED indicator**
Receives command signals from the remote control.
LED indicator:
 - Green: The system is turned on.
 - Red: The system is in standby mode.**Note:** Standby is off by default and needs to be turned on in the Settings menu.
 - Off: The system is shut down.
- 3 [⏻] POWER button(*)**
 - Short press (<3 seconds) to turn the display on or off without shutting down the system.
 - Long press (>3 seconds) to display the power menu and then select **Power off** to turn the system off.
- 4 VOL- button**
Decreases volume.
- 5 VOL+ button**
Increases volume.
- 6 MENU**
Opens the Shortcuts menu.
- 7 HOME**
Returns to the Home screen.
- 8 Return**
Returns to the previous screen or closes the menu.
- 9 Touch pen placements**
Magnetic areas for attaching touch pens.
- 10 Ambient light sensor**
With the built-in Ambient light sensor, user can enable the Adaptive brightness feature to automatically adjust the LCD screen brightness according to the ambient light. This feature comforts the eyes and helps optimize energy efficiently.
Note: Please make sure the Ambient light sensor is not covered when enabling this function.

PRODUCT DESCRIPTION

1.5.2 Input/Output Terminals

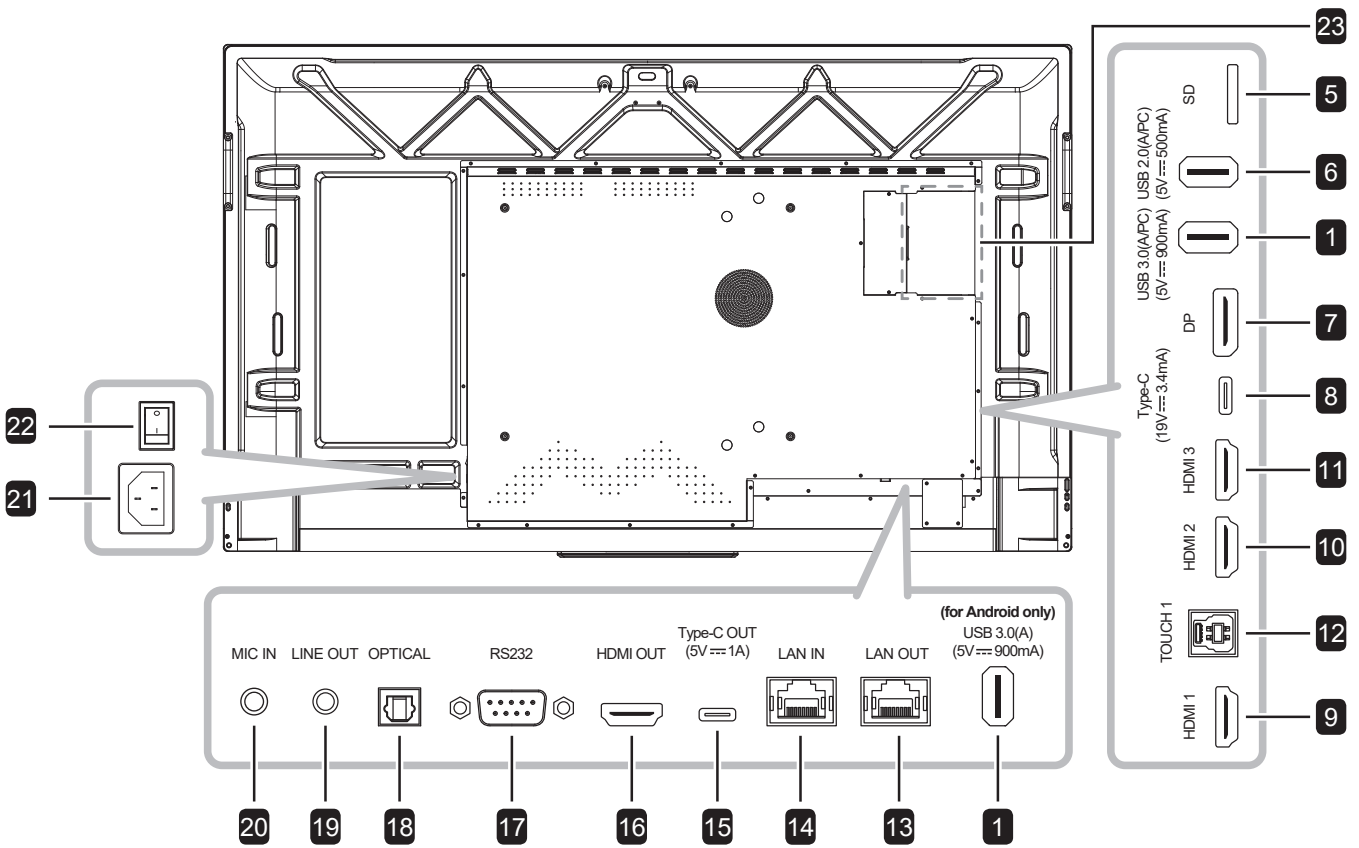
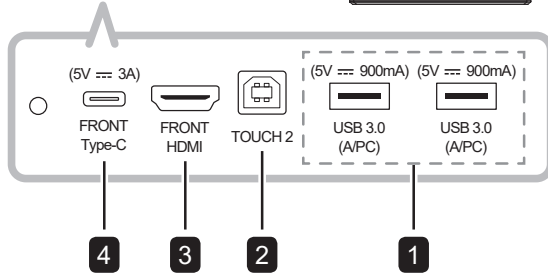

PRODUCT DESCRIPTION

1 USB 3.0

Connects to a USB interface device and charges the device (5V/900mA).

2 TOUCH 2 (USB Type-B)

Connects USB for touch screen control.

3 Front HDMI (HDMI 2.0)

Connects HDMI signals input.

4 FRONT Type-C

Connects to a USB interface device and charges the device (5V/3A).

5 SD

Insert a SD memory card.

6 USB 2.0

Connects to a USB interface device and charges the device (5V/500mA).

7 DP

Connects DisplayPort signals output.

8 Type-C

Connects to a USB interface device and charges the device (19V/3.4A).

9 HDMI 1 (HDMI 1.4)

Connects HDMI signals input.

10 HDMI 2 (HDMI 2.0)

Connects HDMI signals input.

11 HDMI 3 (HDMI 2.0)

Connects HDMI signals input.

12 TOUCH 1 (USB Type-B)

Connects USB for touch screen control.

13 LAN OUT

For internet connection with an Ethernet cable.

14 LAN IN

For internet connection with an Ethernet cable.

15 Type-C OUT

Connects to a USB interface device and charges the device (5V/1A).

16 HDMI OUT

Connects HDMI signals output.

17 RS232

Connects RS232 input from external equipment.

18 OPTICAL

Connects digital audio signals output.

19 LINE-OUT

Connects audio signals output (3.5 mm Stereo Audio Jack).

20 MIC IN

Connects to a microphone.

21 AC Power

AC power input.

22 Main Power

Switches the main power on/off.

23 OPS Slot

Connects the OPS module.

PRODUCT DESCRIPTION

1.6 Remote Control

1.6.1 General Functions

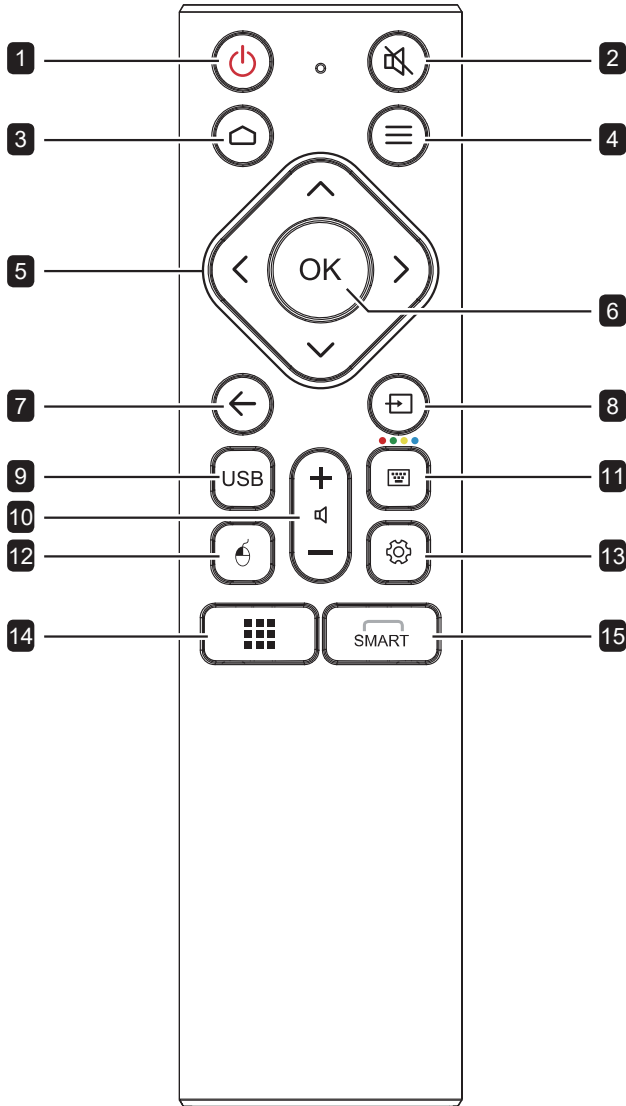

- 1 [Power] Power button:**
Turns the system on or shuts down.
- 2 [Mute] Mute button:**
Turns the mute function on or off.
- 3 [Home] Home button:**
Returns to the Home screen.
- 4 [Slide menu] Slide menu button:**
Opens the Slide menu.
- 5 [Up/Down/Left/Right] Navigation buttons:**
Navigates through the Settings menu and adjusts the settings.
- 6 [OK] OK button:**
Confirms your selection or saves the modifications.
- 7 [Back] Back button:**
Returns to the previous menu or closes the app.
- 8 [Source] Source button:**
Opens the Source menu.
- 9 [USB] File Manager button:**
Opens File Manager.
- 10 [Volume+] [Volume-] Volume button:**
Adjusts volume. Press [Volume+] to increase volume or press [Volume-] to decrease volume.
- 11 [OPS] OPS source button:**
Switches to the OPS source.
- 12 [Mouse] Mouse control button:**
Opens File Manager.
- 13 [Settings] Settings menu button:**
Opens the Settings menu.
- 14 [Whiteboard] Whiteboard button:**
Opens Whiteboard.
- 15 [SMART] Add Bluetooth devices button:**
Opens the Bluetooth device search window.

PRODUCT DESCRIPTION

1.6.2 Inserting the Batteries in the Remote Control

The remote control is powered by two 1.5V AAA batteries.

To install or replace batteries:

- 1 Slide off the battery compartment cover.
- 2 Align the batteries according to the (+) and (-) indications inside the battery compartment.
- 3 Replace the battery compartment cover.

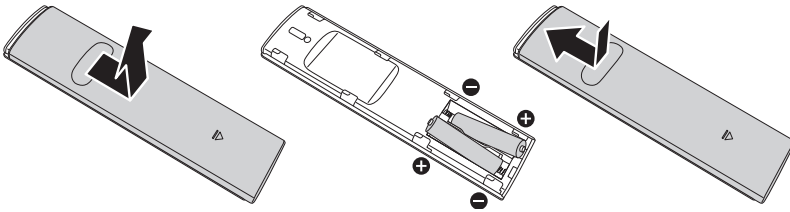

1.6.3 Handling the Remote Control

- Do not subject to strong shock.
- Do not allow water or other liquid to splash the remote control. If the remote control gets wet, wipe it dry immediately.
- Avoid exposure to heat and steam.
- Other than to install the batteries, do not open the remote control.

Caution:

The incorrect use of batteries can result in leaks or bursting. Be sure to follow these instructions:

- ◆ Place “AAA” batteries matching the (+) and (-) signs on each battery to the (+) and (-) signs of the battery compartment.
- ◆ Do not mix battery types.
- ◆ Do not combine new batteries with used ones. It causes shorter life or leakage of batteries.
- ◆ Remove the dead batteries immediately to prevent them from liquid leaking in the battery compartment. Don't touch exposed battery acid, as it can damage your skin.

Note:

- ◆ If you do not intend to use the remote control for a long period, remove the batteries.
- ◆ The remote control may not function properly when the remote control sensor on this display is under direct sunlight or strong illumination, or when there is an obstacle in the path of signal transmission.

PRODUCT DESCRIPTION

1.6.4 Operating Range of the Remote Control

Point the top of the remote control toward the display's remote control sensor (on the left or right side) when pressing a button.

When using the remote control, the distance from the remote control to the sensor on the display should be less than 6m/19ft, and the horizontal and vertical angles should be less than 30°.

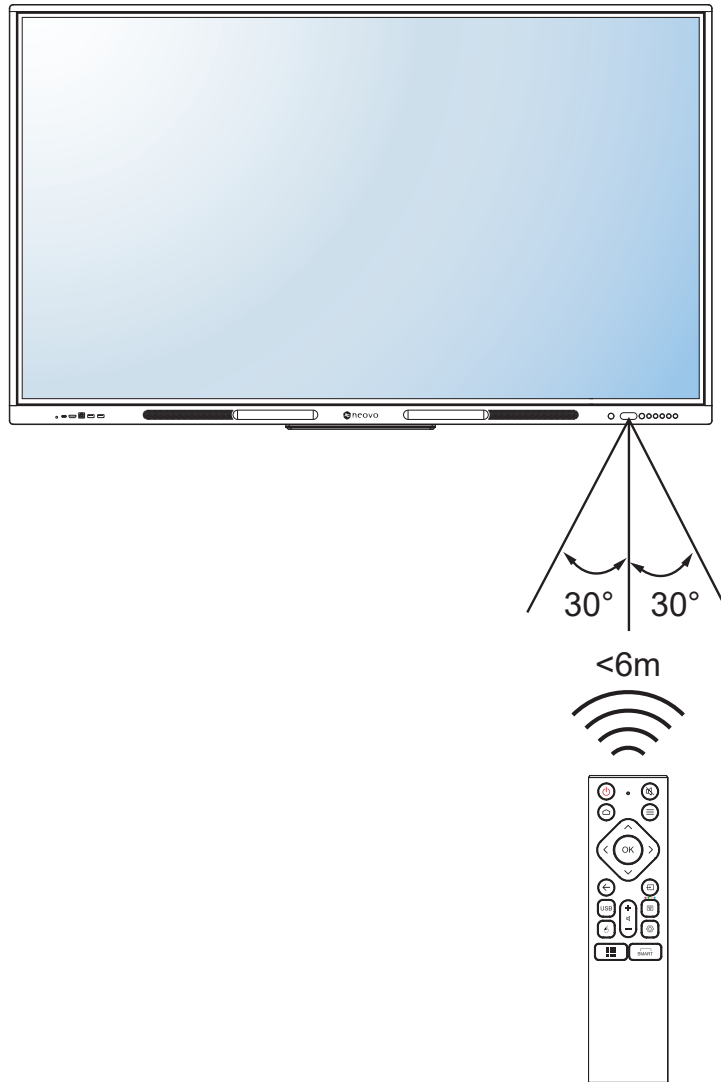

PRODUCT DESCRIPTION

1.6.5 Motion Sensor

To trigger the motion sensor, the distance between the person and the display sensor should be less than 1.6 meters/5 feet, and the horizontal and vertical angles should be less than 35°.

Note:

- ◆ To enable the motion sensor function, please follow these steps in the **Settings > Display > Other display controls** menu.

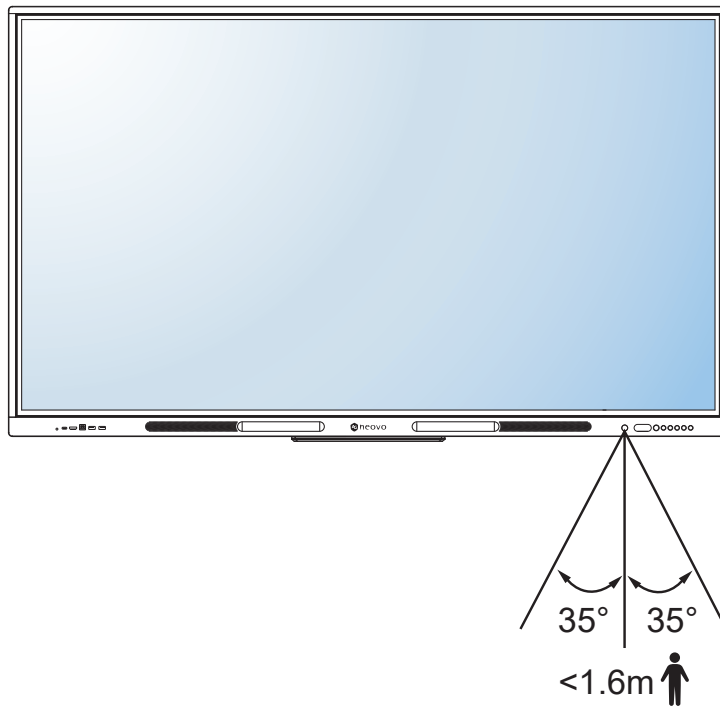

CHAPTER 2: MAKING CONNECTIONS

2.1 Connecting the Power

Note:

- ◆ To operate the interactive display, ensure to use the correct power cord that matches the power outlet in your region.
 - 1 Connect one end of the power cord to the AC IN connector on the interactive display.
 - 2 Connect the other end of the power cord to a power outlet or a power supply.
 - 3 Set the **Main Power** switch to ON.

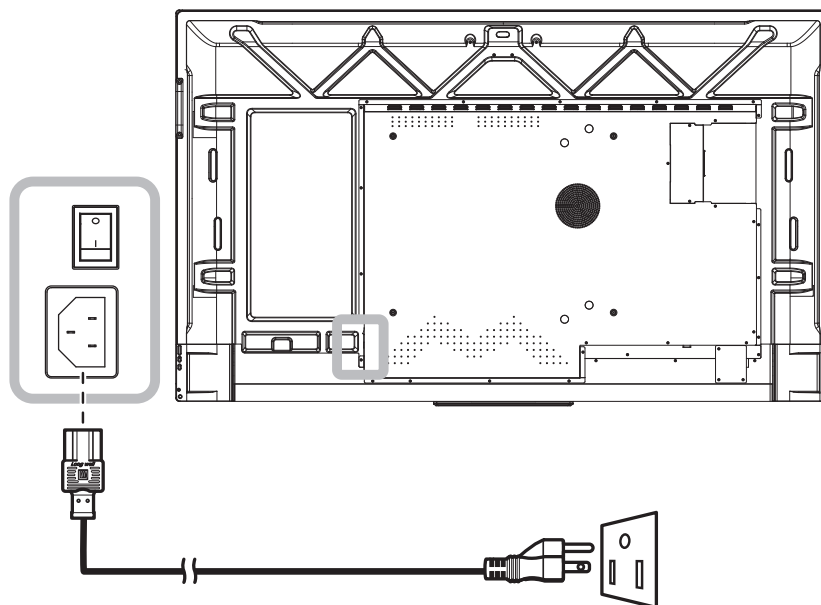

⚡ Caution:

- ◆ Make sure that the interactive display is not connected to the power outlet before making any connections. Connecting cables while the power is ON may cause electric shock or personal injury.
- ◆ When unplugging the power cord, hold the power cord by the plug head. Never pull by the cord.

MAKING CONNECTIONS

2.2 Connecting a Computer or Portable Device

2.2.1 Using RS232 Input

Connect one end of a RS232 serial cable to the RS232 connector of the interactive display and the other end of an RS232 serial cable to the RS232 connector of the computer.

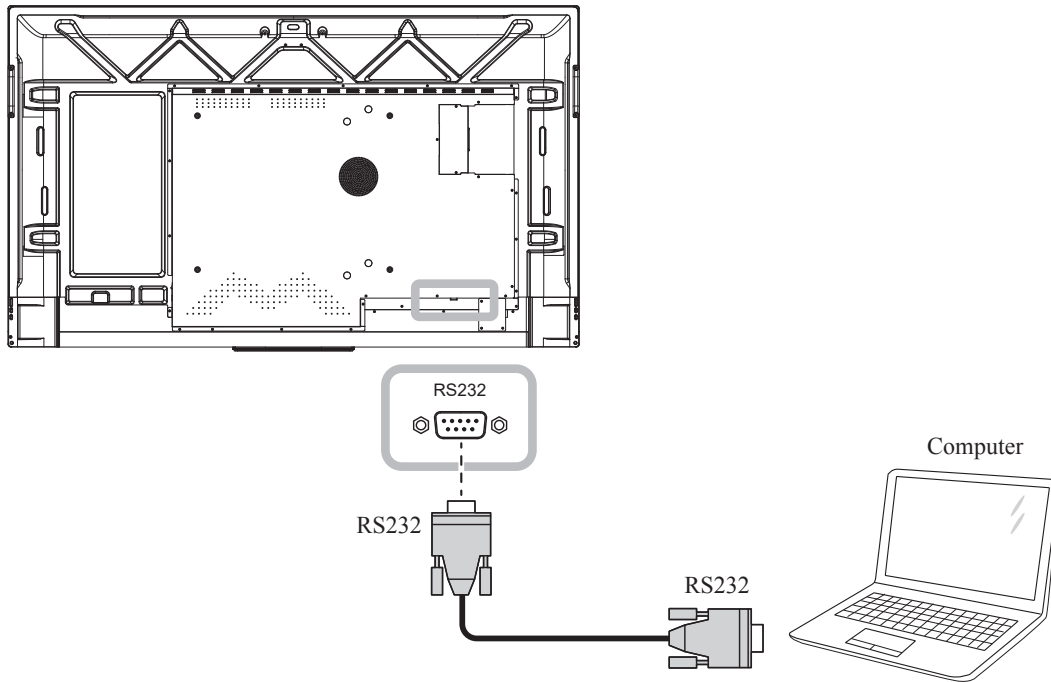

2.2.2 Using HDMI Input

Connect one end of an HDMI cable to the HDMI 1, HDMI 2, or HDMI 3, FRONT HDMI connector of the interactive display and the other end of an HDMI cable to the HDMI OUT connector of the computer.

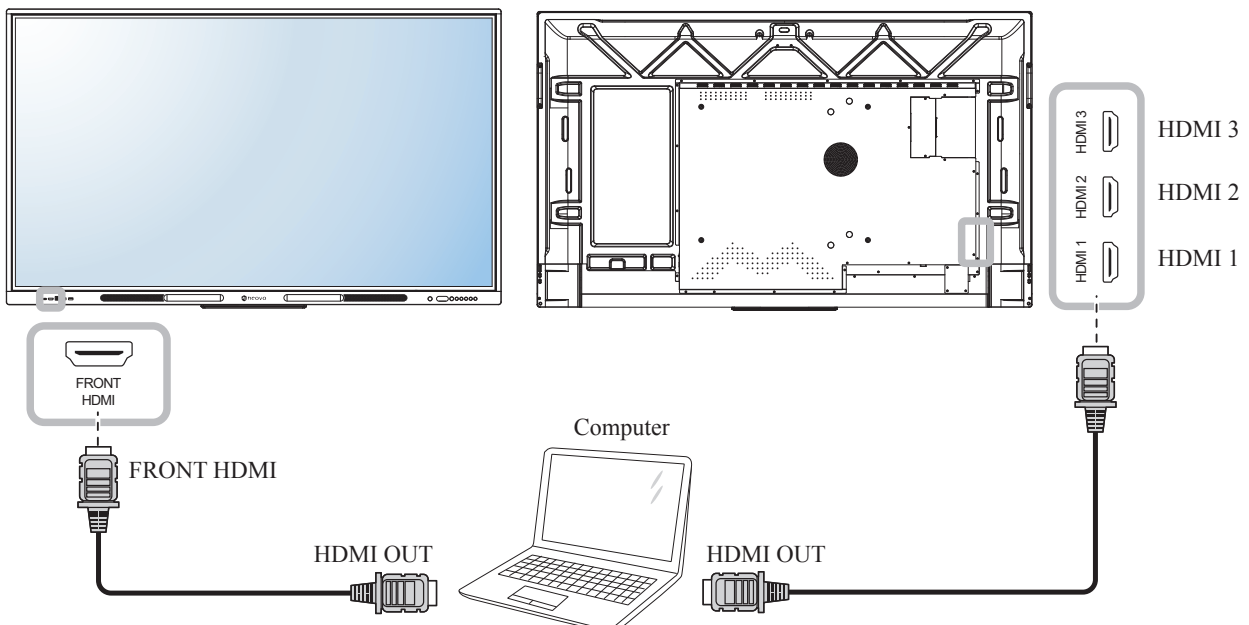

MAKING CONNECTIONS

2.2.3 Using the Touch Module

Interactive display has touch screen functionality which allows you to connect a computer to the display and control the computer's interface via touch gestures on the display. To use this touch screen function, connect the USB cable to the TOUCH 1 or TOUCH 2 port of the display and a computer or USB cable to the USB 3.0 port of the display and a computer.

In addition, perform the following connection:

- For TOUCH 1, connect one end of the HDMI cable to the HDMI 1, HDMI 2, or HDMI 3 port of the display and the other end of the HDMI cable to the HDMI OUT port of the computer.
- For TOUCH 2, connect one end of the HDMI cable to the FRONT HDMI port of the display and the other end of the HDMI cable to the HDMI OUT port of the computer respectively.
- For USB type-C, connect one end of the USB cable to the FRONT Type-C or Type-C port of the display and the other end of the USB cable to the USB type-C port of the computer.

Note:

- ◆ USB type-C connection supports the touch screen function without the need to connect additionally the TOUCH 1/2 ports.

For compatibility options, refer to the following table:

	HDMI 1	HDMI 2	HDMI 3	FRONT HDMI	USB Type-C
TOUCH 1	O	O	O	X	X
TOUCH 2	X	X	X	O	X
USB Type-C	X	X	X	X	O

TOUCH 1

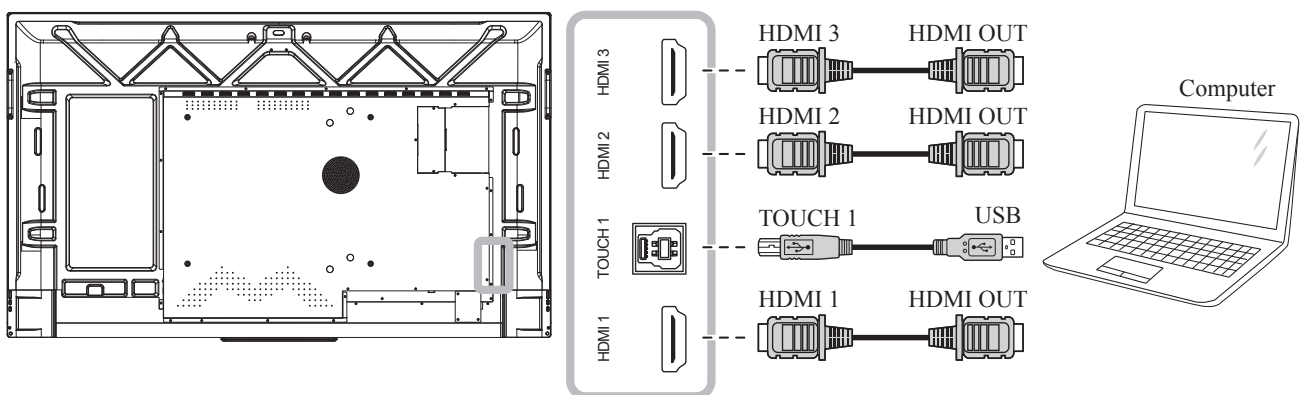

MAKING CONNECTIONS

TOUCH 2

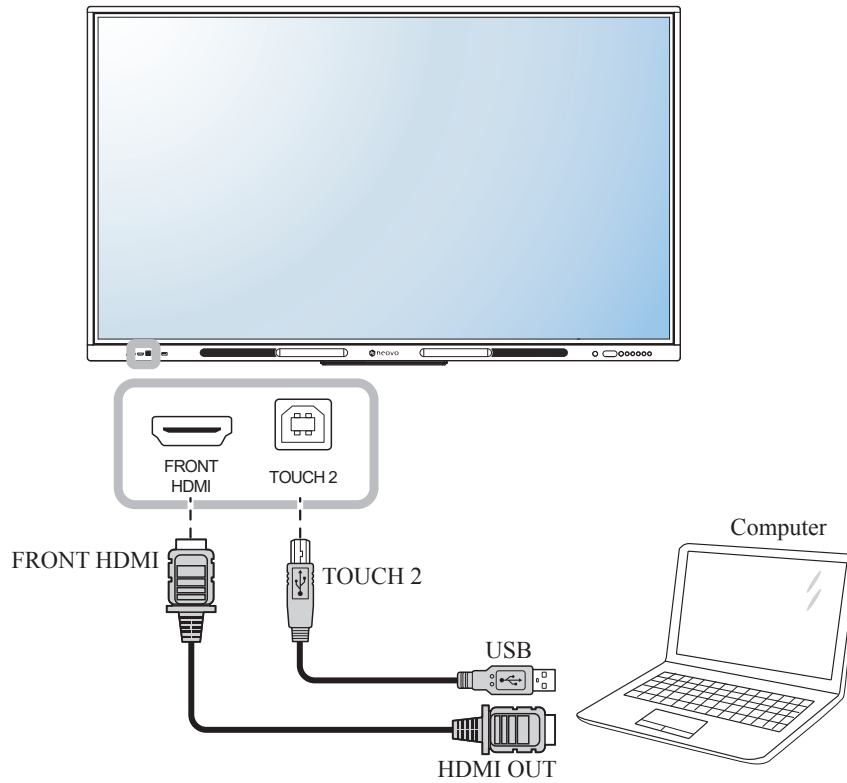

USB Type-C

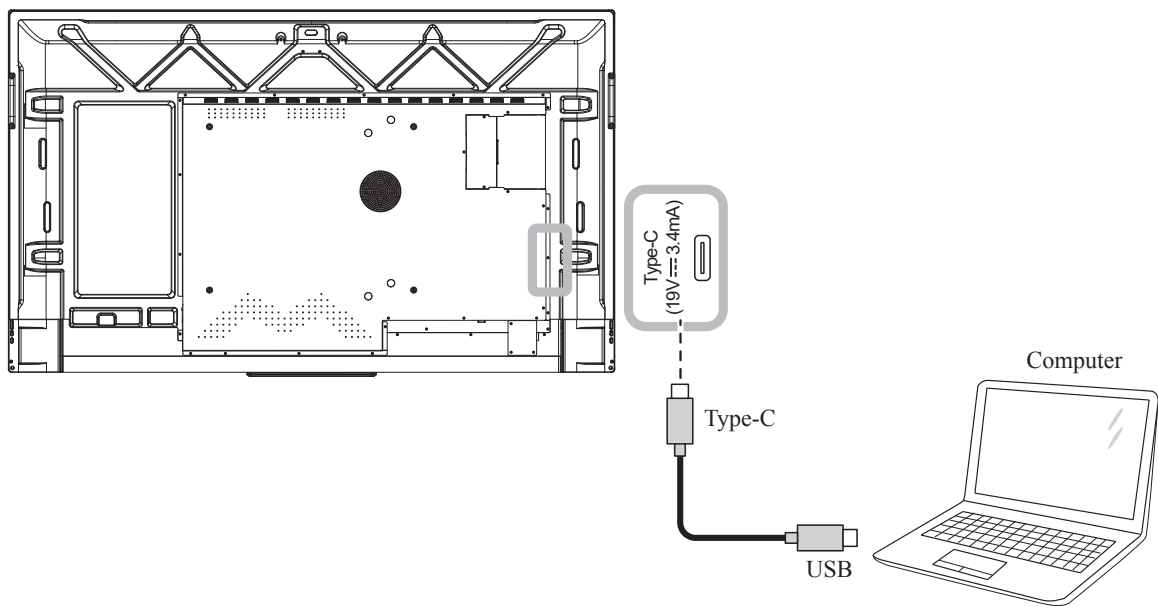

MAKING CONNECTIONS

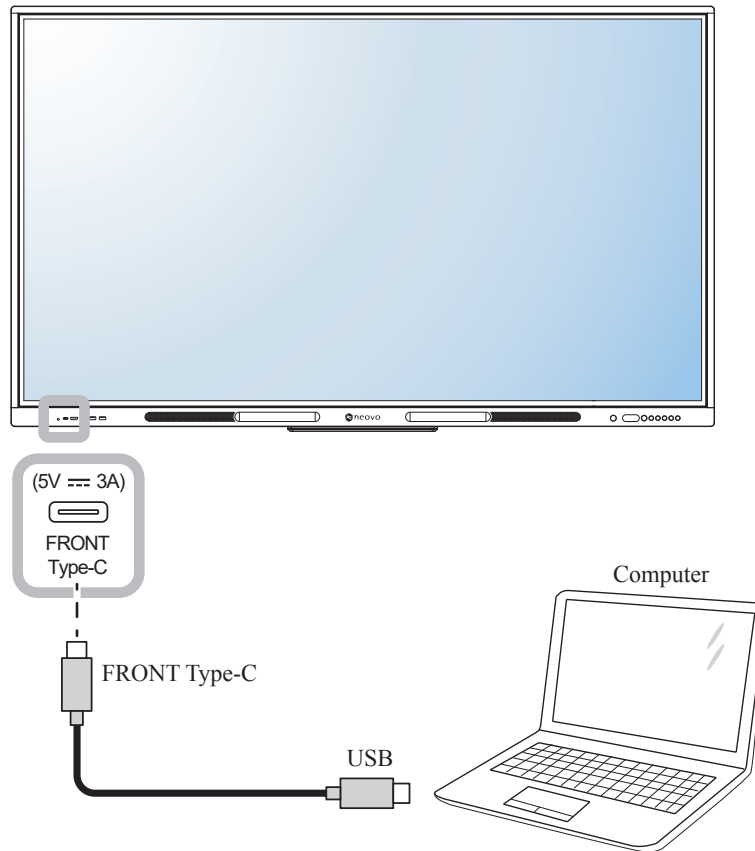

Note:

- ◆ The touch driver will be installed automatically for the following operating systems:
 - One-touch point for Windows 2000/XP/Vista/CE 6.0 and macOS.
 - Multi-touch point Windows 7/8/10/11, Android/Linux (kernel version 3.5+) and Chrome OS (39 or above).
- ◆ Certain touch gestures, such as zoom-in, zoom-out and rotate, may not work depending on the application or software your computer supports.
- ◆ This Touch USB port works only for the touch screen functionality and does not support the external USB devices, such as MP3, printer, and hard drive, or other devices.

MAKING CONNECTIONS

2.2.4 Using DisplayPort Input

Connect one end of the DisplayPort cable to the DP connector of the interactive display and the other end of the cable to the DP connector of the computer.

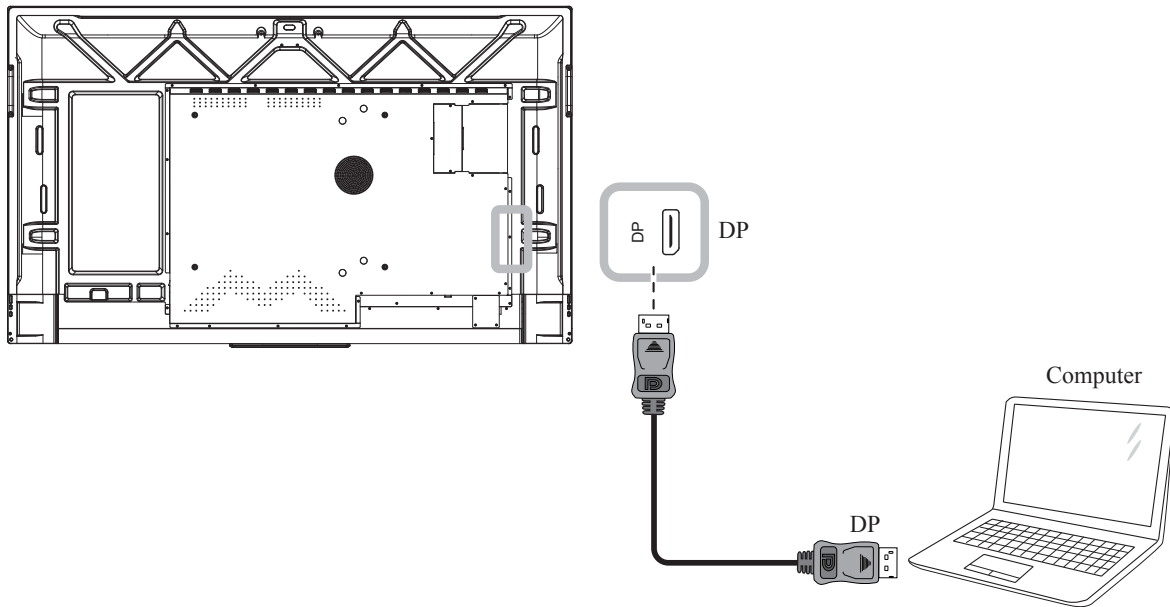

2.3 Connecting External Equipment

2.3.1 Connecting a Video Player

Connect one end of an HDMI cable to the HDMI 1, HDMI 2, or HDMI 3 connector of the interactive display and the other end of an HDMI cable to the HDMI OUT connector of the video player.

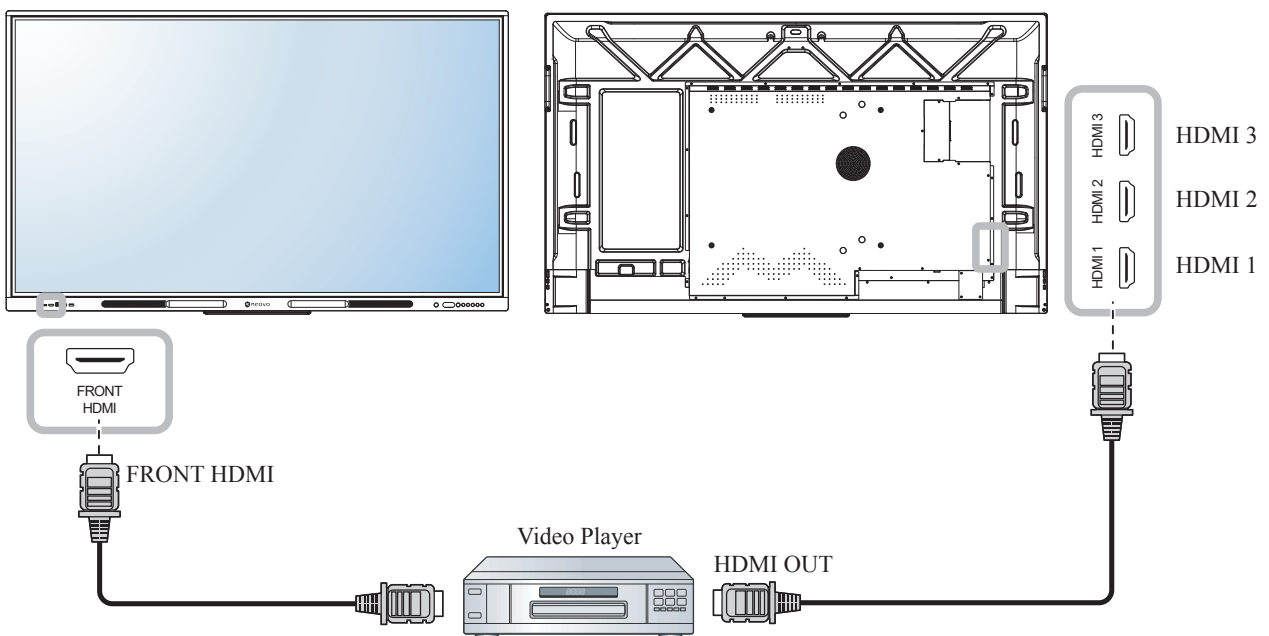

MAKING CONNECTIONS

2.3.2 Connecting a Microphone

Connect the microphone to the MIC IN connector of the interactive display.

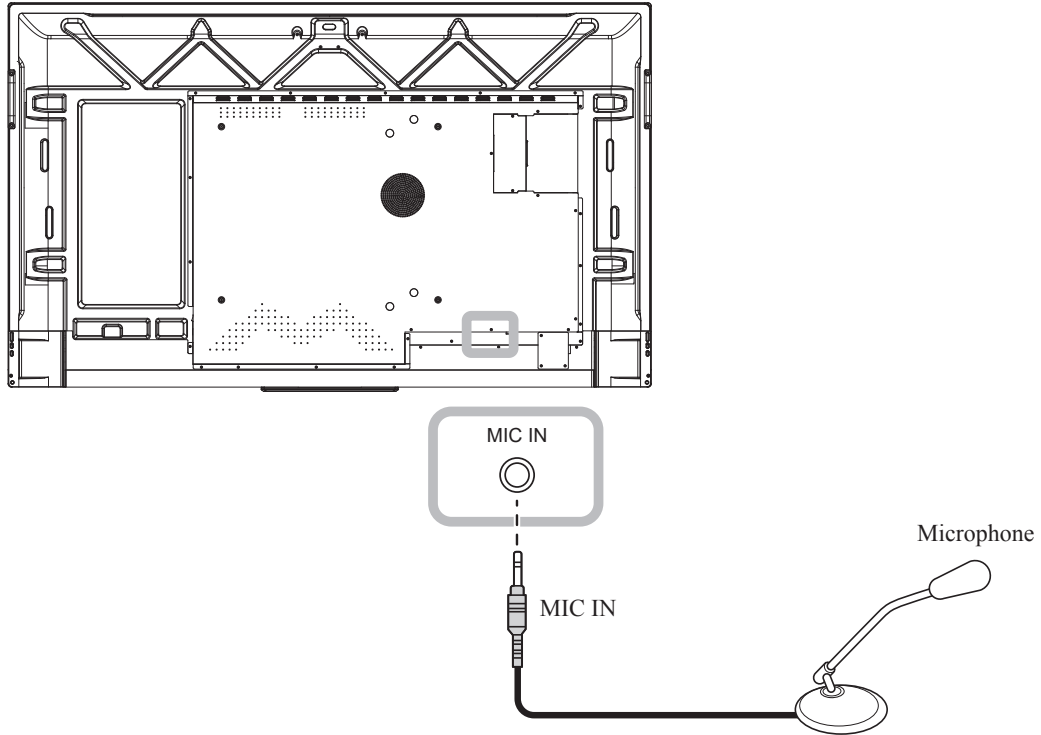

MAKING CONNECTIONS

2.3.3 Connecting Audio Equipment

Connect one end of an audio cable to the LINE OUT connector of the interactive display and the other end of an audio cable to the AUDIO IN connector of the audio device.

For digital audio output, connect one end of an audio cable to the OPTICAL connector of the interactive display and the other end of an audio cable to the SPDIF IN connector of the audio device.

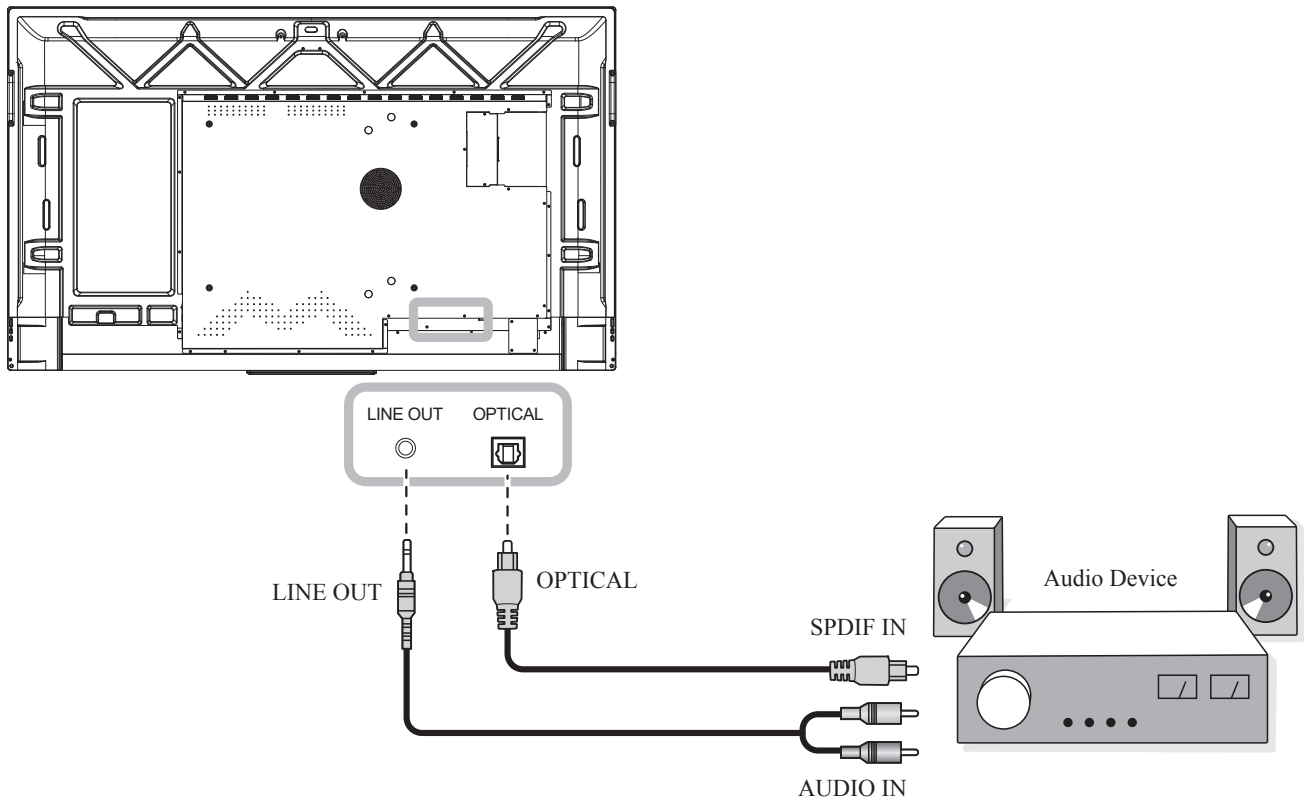

MAKING CONNECTIONS

2.4 Connecting a Display Device

Connect one end of an HDMI cable to the HDMI OUT connector of the interactive display and the other end of an HDMI cable to the HDMI IN connector of the display device.

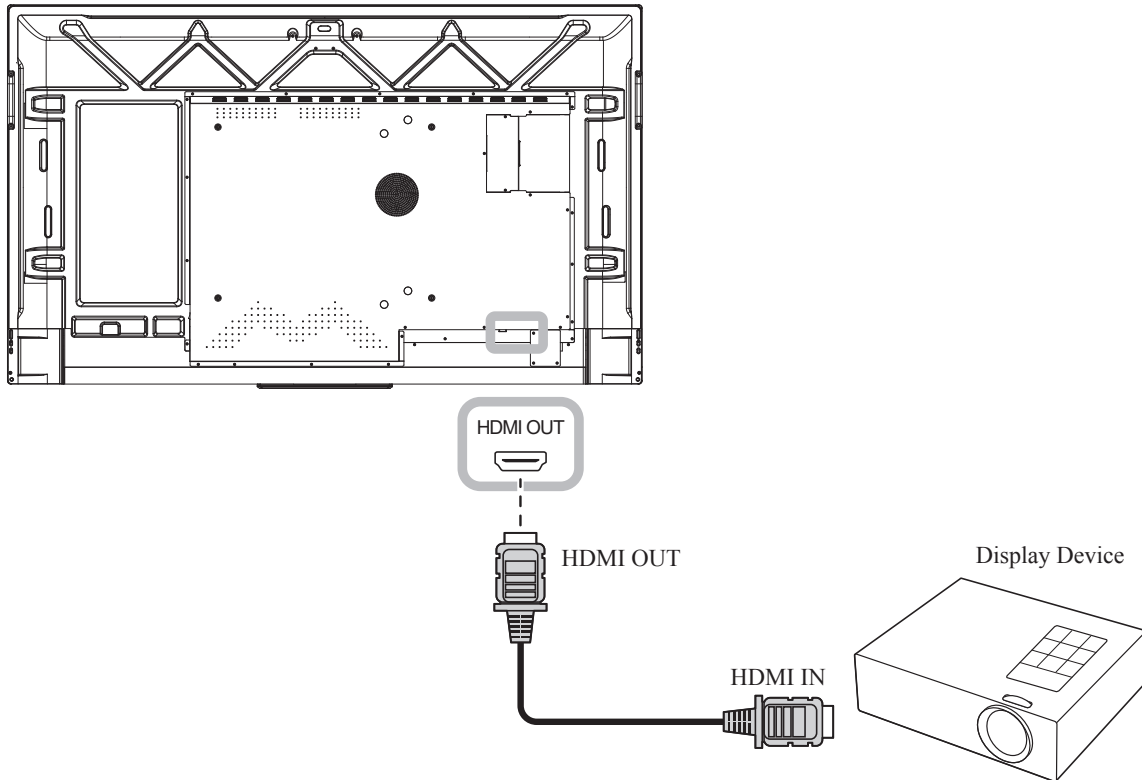

MAKING CONNECTIONS

2.5 Connecting to a Wired Network

Connect one end of a network cable (RJ45) to the LAN IN connector of the interactive display and the other end of a network cable to a network hub, switch, or router.

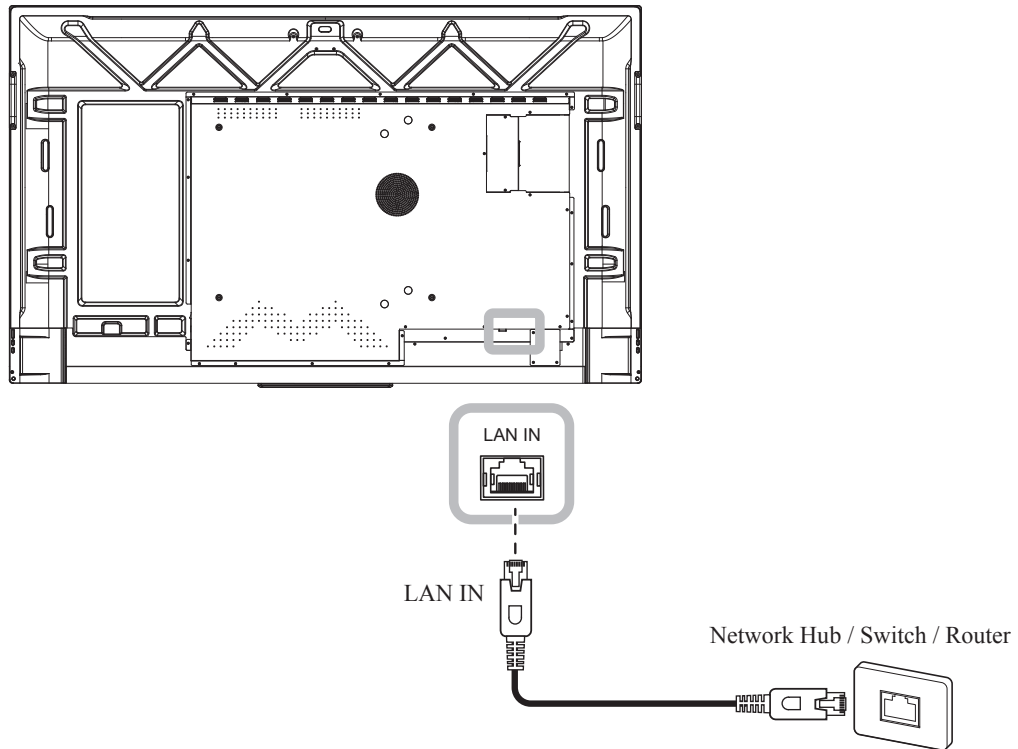

2.6 Connecting USB Interface Devices

Connect a USB interface device (keyboard, mouse, USB storage, and more) to USB 3.0 ports of the interactive display.

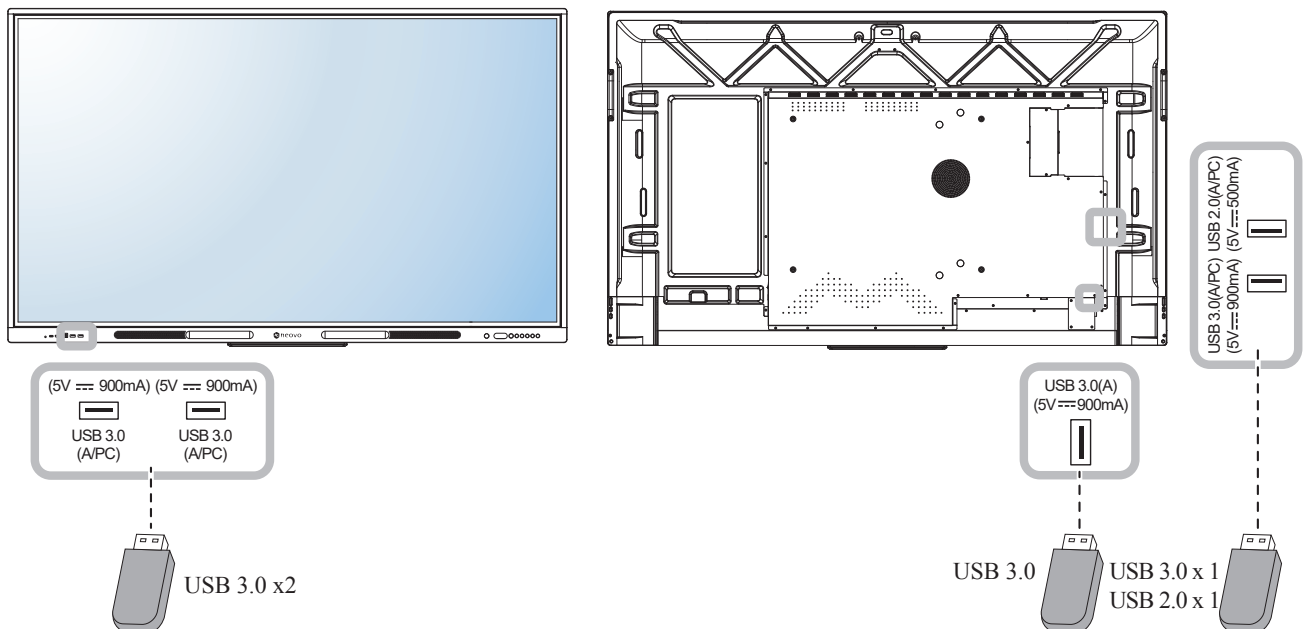

MAKING CONNECTIONS

2.7 Connecting a MicroSD Card

Connect a microSD card to the SD slot of the interactive display.

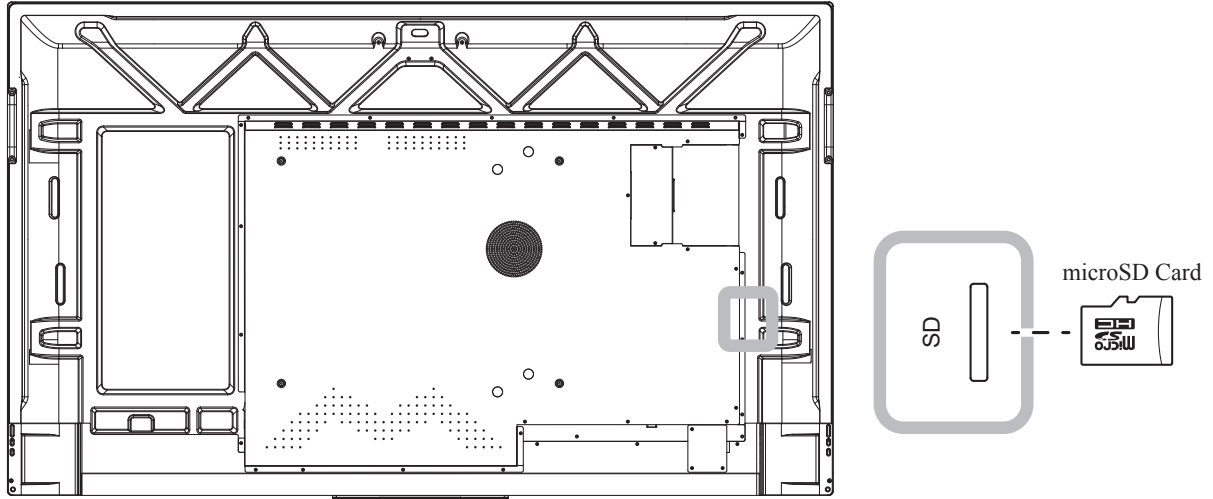

2.8 Attaching Touch Pens

Attach the touch pen to the magnetic areas of the interactive display's front panel.

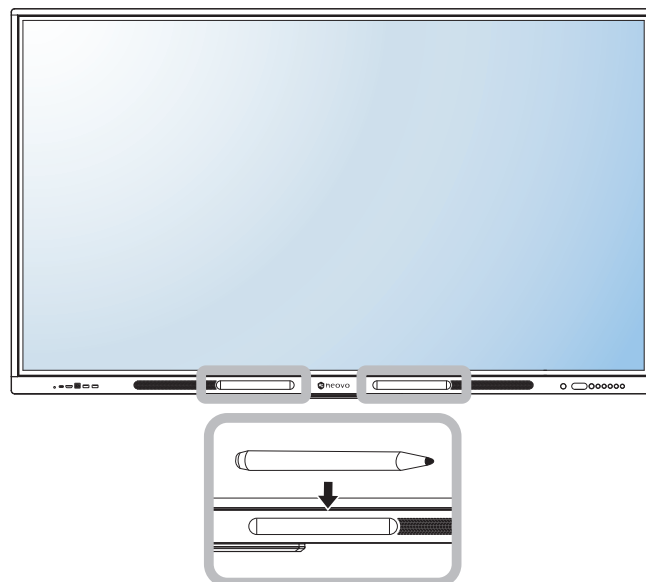

MAKING CONNECTIONS

2.9 Attaching an OPS

Insert the OPS to the OPS slot on the side of the interactive display.

Note:

- ◆ Ensure that the OPS module size is 180 x 119 x 30 mm and the power rating is 18V; 5A.

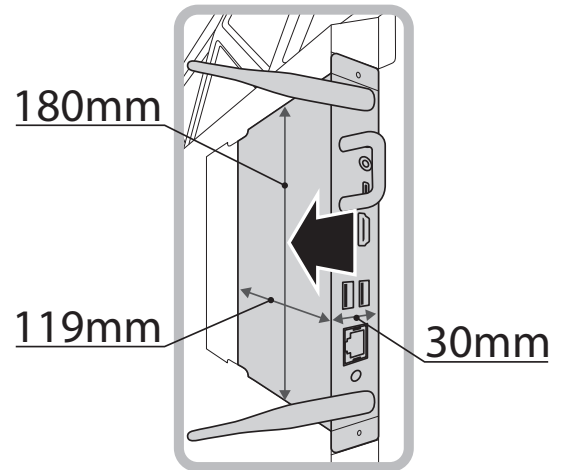
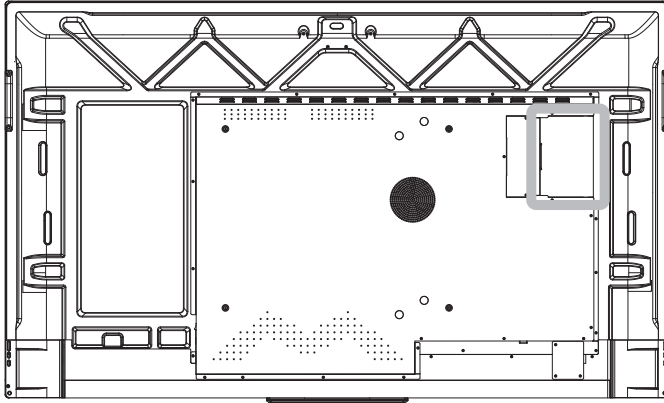

CHAPTER 3: USING THE INTERACTIVE DISPLAY

3.1 Turning on the Power

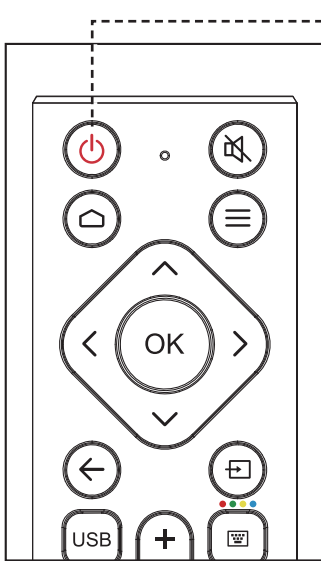

- 1 Plug the power cord to a power outlet or power supply.
- 2 Press the  button to turn the LCD display on.

When the LCD display is turned on, long press the  button to turn off the LCD display.

Note:

- ◆ The interactive display still consumes power as long as the power cord is connected to the power outlet. Disconnect the power cord to completely cut off power.

3.1.1 Initial Setup

After you turn on the interactive display, you are prompted to select the default system language, configure network settings, and more. Follow the on-screen instructions to complete the initial setup.

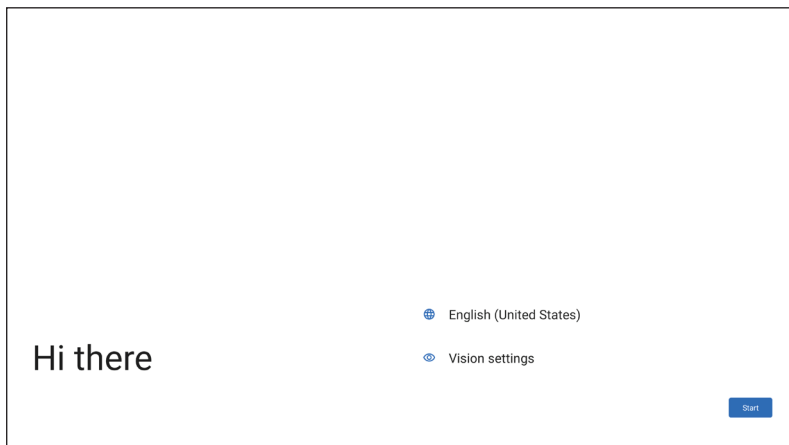

Note:

- ◆ The initial setup screen is prompted only the first time you use the interactive display or after resetting the system.

USING THE INTERACTIVE DISPLAY

Please follow the instructions to turn on the Slide menu and switch to the Standard home page.

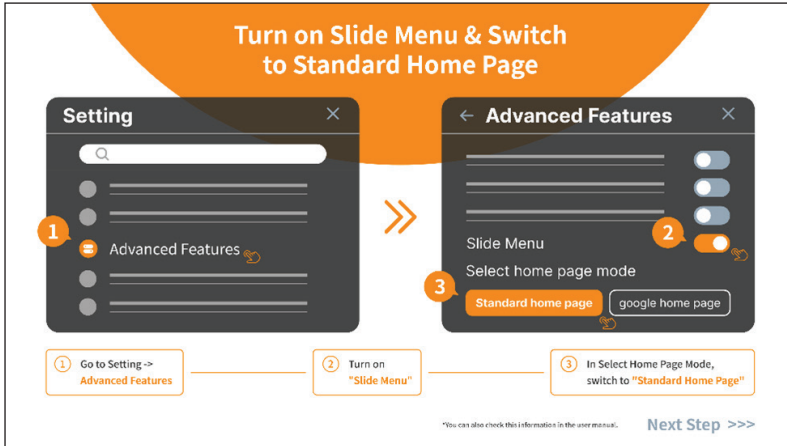

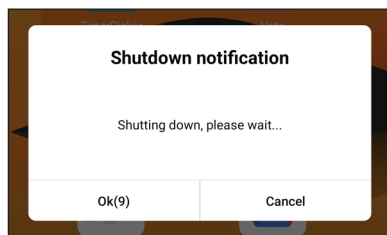

3.1.2 Powering Off

Long press the  button. Touch **OK** at the prompt to turn the interactive display off immediately or wait for 10 seconds until it turns off automatically.

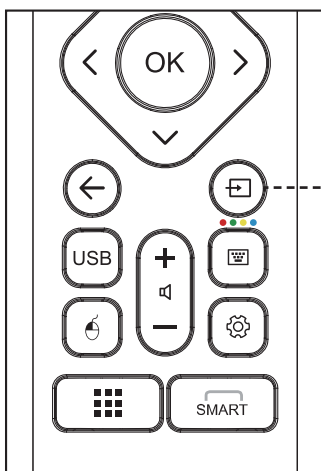

3.2 Selecting the Input Source Signal



- 1 Press the  button.
- 2 Press the < or > button to select a source, then press the **OK** button to confirm.

Note:

- ◆ To open the OPS source directly, press .

USING THE INTERACTIVE DISPLAY

Note:

- ◆ After pressing the **Source** button, the Source menu will be displayed on the screen. In the Source menu, you can also select the picture mode, color temperature, and aspect ratio.

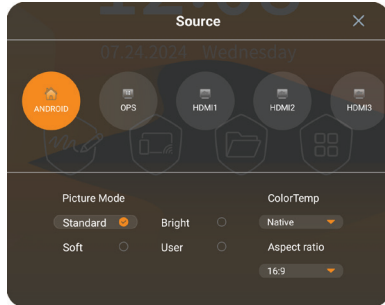

3.3 Muting the Sound

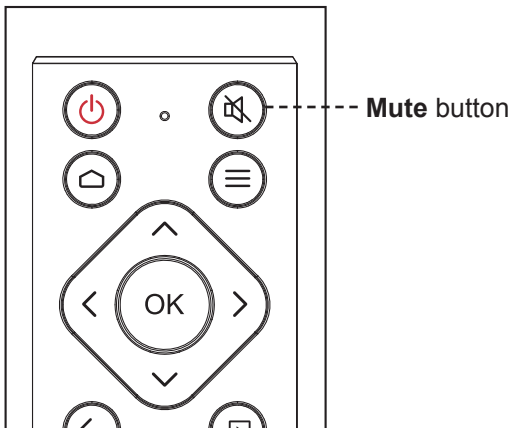

Press the  button to mute or unmute the sound.

Note:

- ◆ If you mute the sound, then the  icon will appear on the upper right side of the screen.

USING THE INTERACTIVE DISPLAY

3.4 Adjusting the Volume

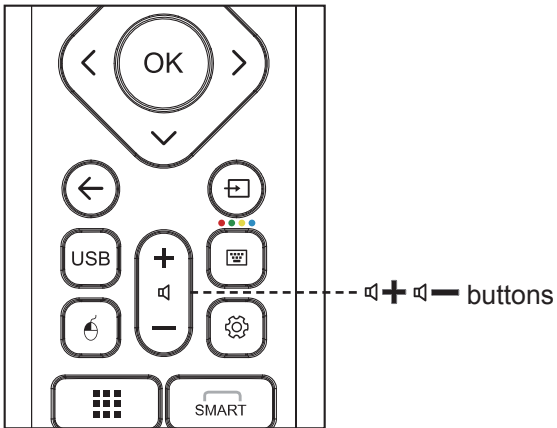

Press the button to increase the volume or the button to decrease the volume.

Note:

- ◆ After pressing the or button, you will see the volume adjustment menu. Tap to enable or disable sound when a notification arrives, tap and slide it up or down to manually adjust the volume, tap to configure more sound settings, or tap to enable or disable detecting speech and generate auto captions.



USING THE INTERACTIVE DISPLAY

3.5 Android Functions

3.5.1 Accessing the Home Screen

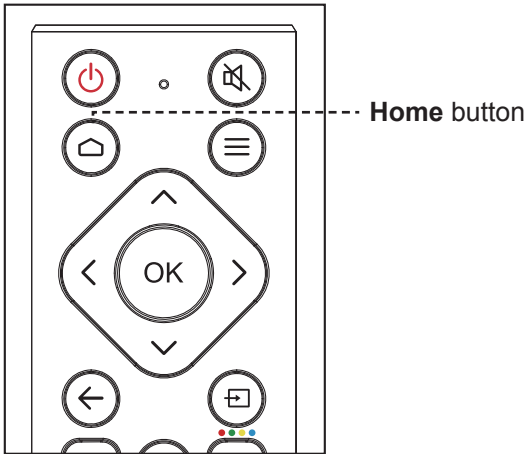

Press the  button to access the Home screen of the system. For more information on the Home screen, refer to the “About the Home Screen” section.

3.5.2 Accessing the Slide Menu

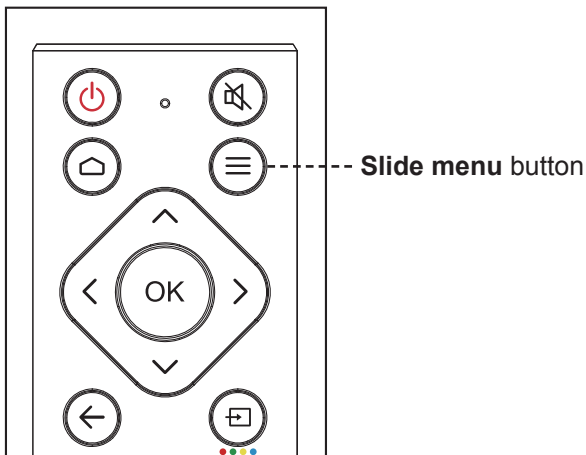

Press the  button to launch the Slide menu. For more information on the Slide menu, refer to the “Using the Slide Menu” section.

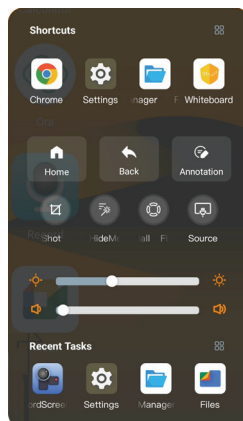

USING THE INTERACTIVE DISPLAY

3.5.3 Returning to the Previous Screen

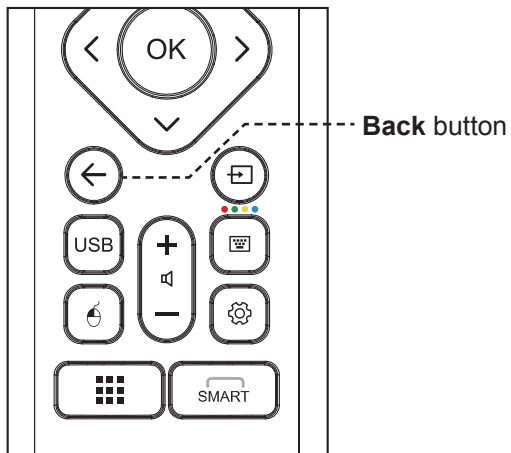

Press the ← button to return to the previous screen or close the menu or app.

3.5.4 Accessing the File Manager

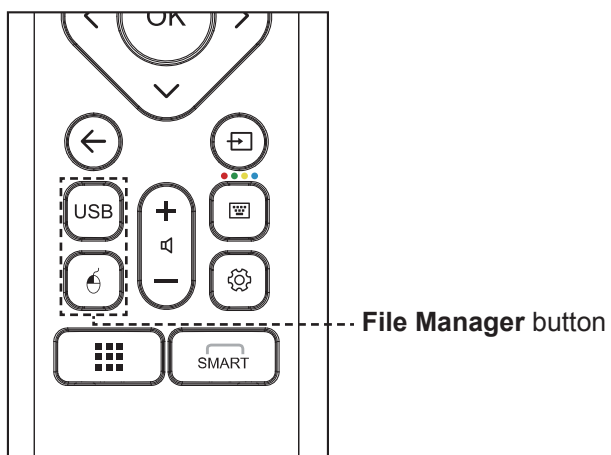

Press the USB or  button to launch **File Manager**. For more information on the File Manager, refer to the “File Manager” section.

USING THE INTERACTIVE DISPLAY

3.5.5 Accessing the Settings Menu

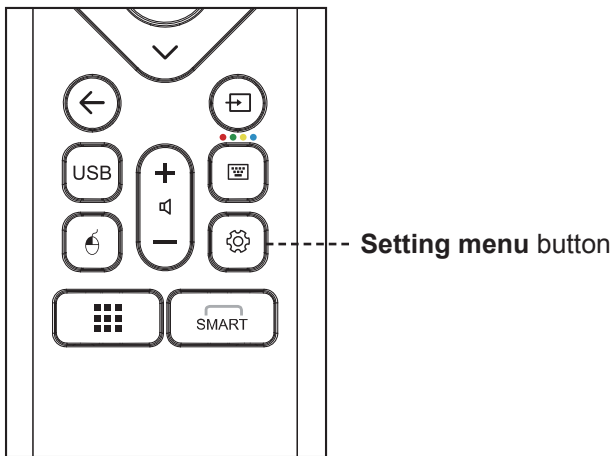

Press the  button to open the Settings menu. For more information on the Settings menu, refer to the “Configuring System Settings” section.

3.5.6 Accessing the Whiteboard

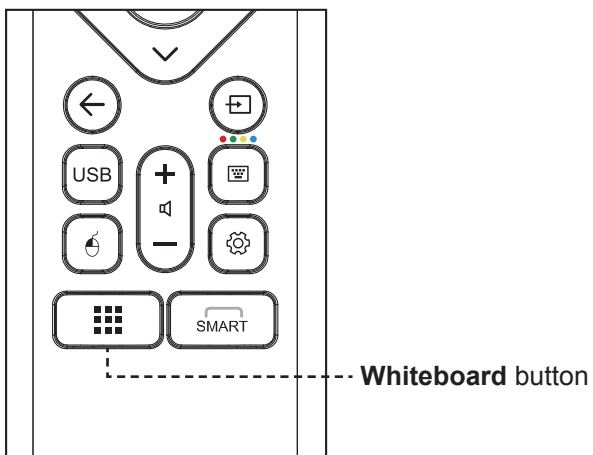

Press the  button to open **Whiteboard**. For more information on **Whiteboard**, refer to the “Whiteboard” section.

USING THE INTERACTIVE DISPLAY

3.5.7 Adding a Bluetooth Device

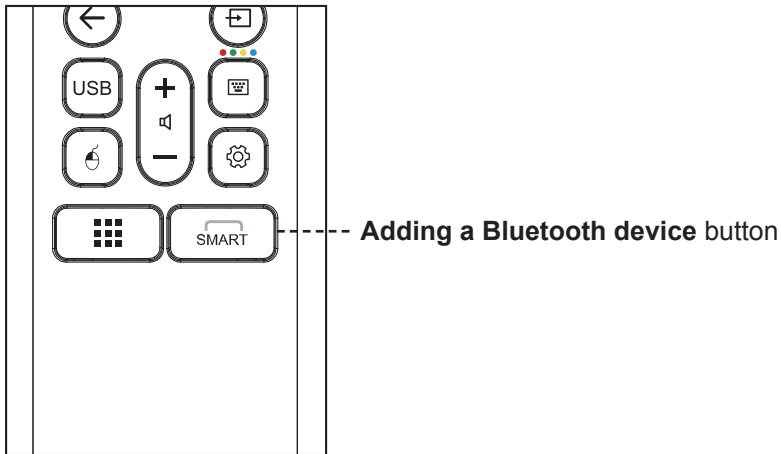

Press the  button to add a Bluetooth device.

- 1 Tap on the device you want to add.

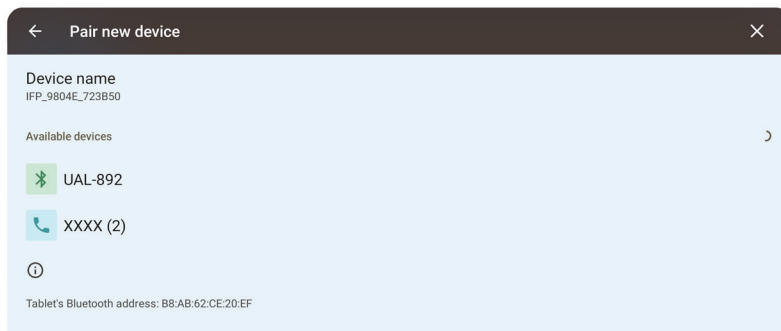

- 2 Verify the codes in both devices and if they match, tap **Pair**.

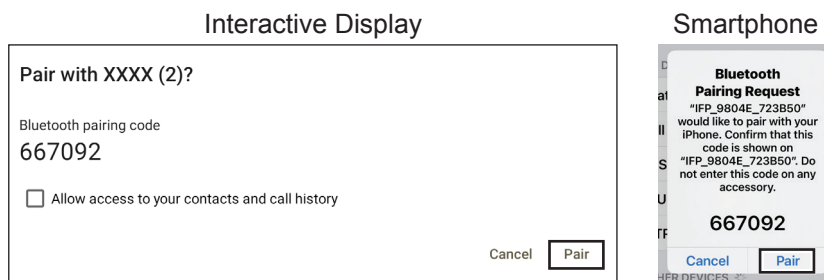





USING THE INTERACTIVE DISPLAY

3.6 Using the Touchscreen

In addition to the remote control, you can also operate your interactive display using the touch gestures as described in the tables below.

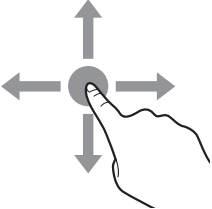
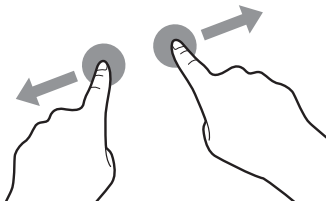
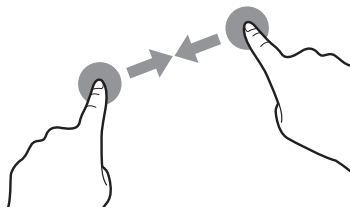
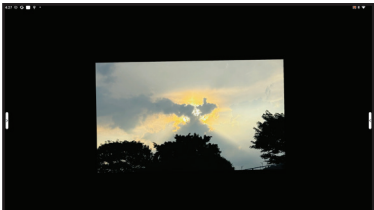
For Android



Action	Touch Gesture	Function
Touch		<p>Touch to open clickable items on the screen, such as apps, Slide menu options, and more.</p> <p>Note:</p> <ul style="list-style-type: none"> ◆ Always touch the screen with your finger or with the supplied touch pen. ◆ Do not touch the screen with sharp, metallic objects that could scratch the screen's coating.
Touch and hold		<ul style="list-style-type: none"> • Manage the Apps screen. • Move the Slide menu shortcuts >/< up or down based on your preferences. • Adjust settings by dragging the slider up, down, left, or right. • Modify the Home screen wallpaper and style. Refer to the “- Dark theme: Enable or disable dark background.Customising the Home Screen” section.
Drag or swipe		<ul style="list-style-type: none"> • Zoom in and zoom out on the image. For example:
Zoom	<p>Zoom in</p>  <p>Zoom out</p> 	<p>Zoom in</p>  <p>Zoom out</p> 

USING THE INTERACTIVE DISPLAY

For Windows

Note:

- ◆ Make sure you have connected properly the Windows-based device to the interactive display.
- ◆ Multi-touch functions are only supported on Windows 11, Windows 10, Windows 8, Windows 7 Home Premium /Professional / Enterprise / Ultimate operating systems and not supported on Windows XP, Windows Vista, and Windows 7 Starter / Home Basic.
- ◆ Windows is a registered trademark of Microsoft Corporation in the United States and other countries.

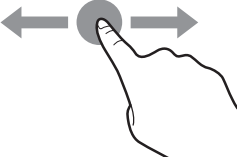
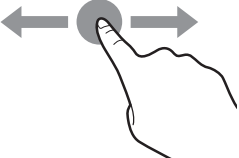
Function	Touch Gesture	Action
Single-touch gestures:		
Note:		
◆ For Windows XP, Windows Vista, Windows 7, Windows 8, Windows 10, and Windows 11.		
Tap		Touch the screen once.
Double-tap		Touch the screen twice.
Right-tap		Touch and hold on the target until a blue ring appears. Then release your finger.
Drag		Touch the screen and drag with one finger to the left or to the right.
Note:		
◆ For Windows Vista, Windows 7, Windows 8, Windows 10, and Windows 11.		
Selection		Touch the screen and drag with one finger to the left or to the right.

USING THE INTERACTIVE DISPLAY

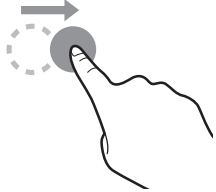
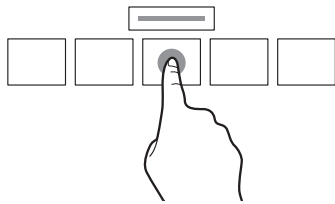
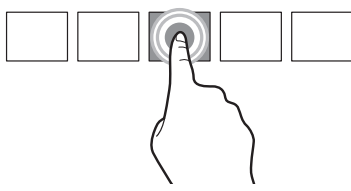
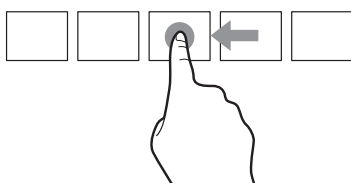
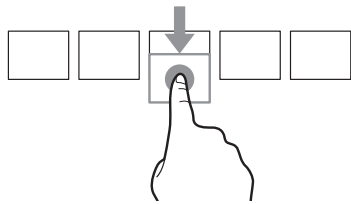
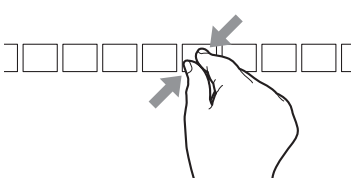

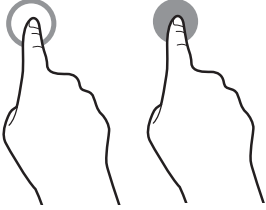
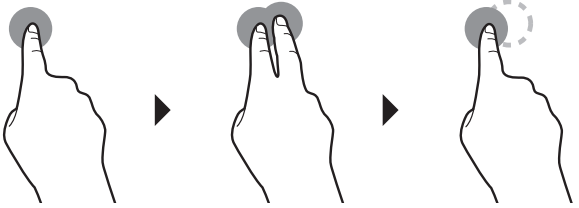
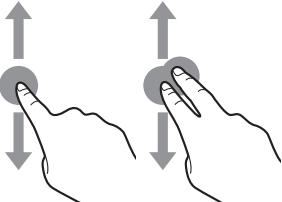
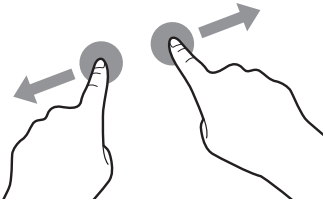
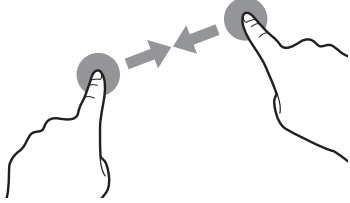

Function	Touch Gesture	Action
Pan up / Pan down / Back / Forward		Touch the screen and quickly drag your finger to the desired direction.
Note:		
♦ For Windows 8		
Learn		Touch and hold the screen to display more information. Anything displayed this way should not prevent you panning.
Primary action		Touch the target to invoke its primary action. For example, launch an app or execute a command.
Pan		Touch the screen and slide for panning interactions, moving items, drawing, or for writing. Slide can also be used to target small, densely packed elements by scrubbing (sliding the finger over related objects, such as radio buttons).
Select, command, and move		Touch the screen and swipe to select, command, and move. Sliding your finger a short distance, perpendicular to the panning direction, selects objects in a list or grid and displays the app bar with related commands when objects are selected.
Zoom		Touch the screen and pinch or stretch to zoom out or zoom in respectively. The pinch and stretch gestures are more commonly used for resizing but also enable to move to the beginning, end, or anywhere within content with semantic zoom.
Note:		
♦ For Windows XP, Windows Vista, and Windows 7		

USING THE INTERACTIVE DISPLAY

Function	Touch Gesture	Action
Wake the computer up from the standby mode (S3)		Touch and hold the screen for around 4 seconds.
Multi-touch gestures:		
Note:		
◆ For Windows 7 Home Premium / Professional / Enterprise / Ultimate version		
Right-tap		Touch and hold on the target and quickly touch the screen once with another finger.
Scrolling		Touch and drag the screen with one or two fingers up or down.
Zoom	<p style="text-align: center;">Zoom in</p>  <p style="text-align: center;">Zoom out</p> 	Touch the target and move your two fingers apart or toward each other to zoom in or zoom out respectively.

USING THE INTERACTIVE DISPLAY

3.7 Using the On-Screen Keyboard

Whenever you need to input text, an on-screen keyboard opens automatically. Touch the keys on the screen as you would press the keys on a connected keyboard. To customize the keyboard layout, tap , to enable or disable clipboard, tap , to extend the keyboard, tap , to display the keyboard in a compact mode, tap , to enable or disable speech to text feature, tap . To close the on-screen keyboard, tap anywhere on the screen outside the keyboard.



CHAPTER 4: USING THE SYSTEM

4.1 About the Home Screen

After you power on the system, you will see the Home screen. On the Home screen, you can view the current date and time, access the Slide menu and various apps.

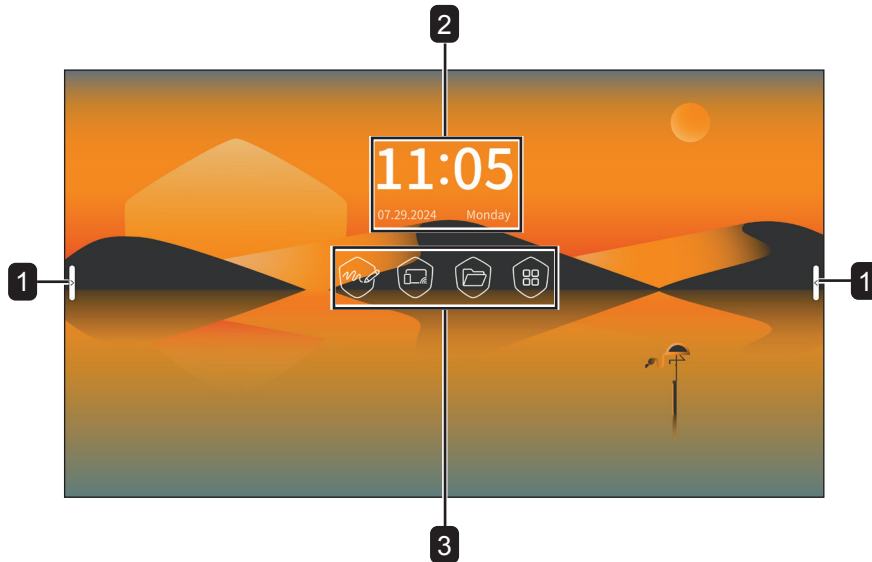

#	Item	Description
1	Slide menu	Quick access for apps, Home screen, move backwards, annotation and screenshot tool, smart hide menu, Float Ball, Source menu, screen and volume adjustment, and recent tasks. Note: ◆ The Slide menu icons >/< are visible on both sides of the interactive display.
2	Date and Time	Displays the current date and time. Adjust the date and time in the Settings menu.
3	App Shortcuts	Accesses the Whiteboard app, Montage app, File Manager app, and Apps screen.

Note:

- ◆ To move between different Home screens, swipe the screen to the left or to the right. For example, to access the Apps screen, swipe the Home screen to the left or touch .

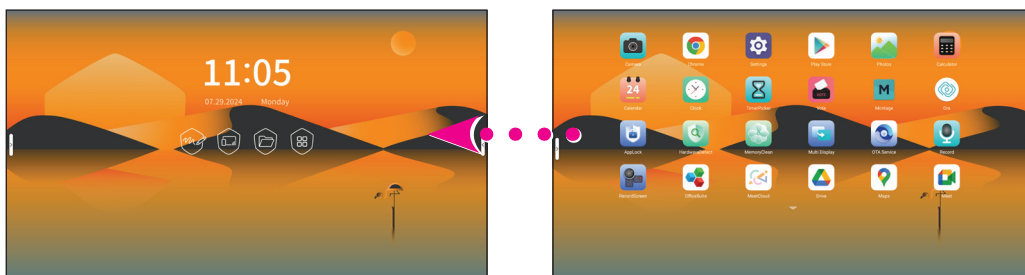

USING THE SYSTEM

4.2 Using the Slide Menu

The Slide menu can be accessed on either sides of the interactive display by touching >/< or by pressing ≡ on the remote control. For more convenient access, you can touch and hold on the Slide menu icon to slide it up or down. Slide menu icons are always visible on the screen regardless of your location in the user interface.

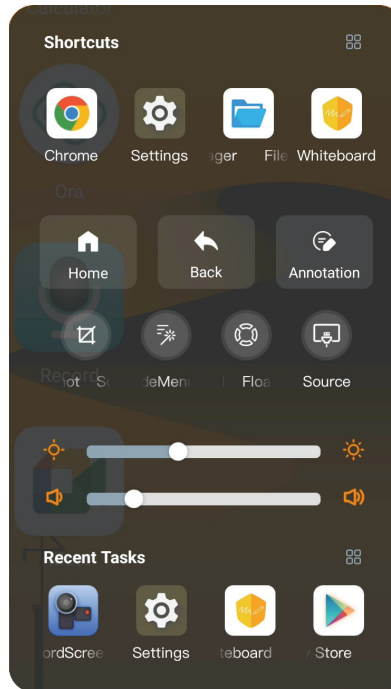

Note:

- ◆ If the Slide menu is not visible, ensure that the Slide menu is enabled in the **Settings > Advanced Features** menu.

Access any of the following Slide menu items based on your needs:

- Touch the app you want to open in the Shortcuts menu.
To reorganize the app shortcuts, touch ≡ > [X]. Touch the app icon you want to remove from shortcuts and then touch the app icon that you want to add. You can add up to 4 app shortcuts. The apps that are added, have (✓) icon next to them. Touch **Save** to save the modifications.

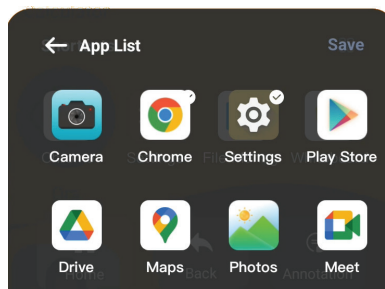

- Touch **Home** to access the Home screen from any other screen or menu.
- Touch **Back** to return to the previous menu or close the app.
- Touch **Annotation** to enter the writing mode. For more information, refer to page 67
- Touch **ScreenShot** to capture the screen image. For more information, refer to page 68.
- Touch **Smart Hide Menu** to hide or display the Slide menu.



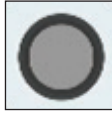

USING THE SYSTEM

- Touch **Float Ball** to display the Float Ball menu on the screen.

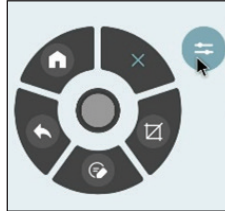



To open the Float Ball menu, touch .



Touch  to return to the Home screen,  to return to the previous menu or close app,  to enter the writing mode and annotate the screen,  to capture the screen, or  to minimize the Float Ball menu.

Note:

- ◆ You can modify the app shortcuts in the Float Ball menu. Touch  to open the All Shortcuts panel. These two apps that appear in the Float Ball menu, have  next to them. Touch the app you want to remove and then touch the app you want to add. The app shortcut is added to the Float Ball menu automatically. Touch  to close the All Shortcuts panel and return to the Float Ball menu.

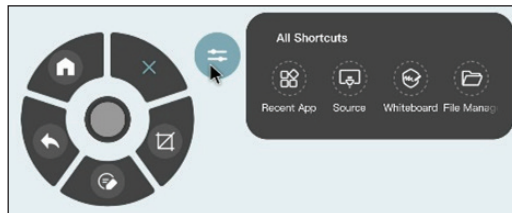



- Touch **Source** to select an input source.
- Drag the slider to the left to decrease the screen brightness or to the right to increase the brightness.



- Drag the slider to the left to decrease volume or to the right to increase volume.



USING THE SYSTEM

- Recent Tasks menu displays the latest four apps that you have opened on the interactive display and are currently running in the background. To access the app, simply touch the app icon.
To view and manage all apps that are currently opened, touch . Then touch  next to the app that you want to close. To close all opened apps, touch the wording **“Clear All”**.

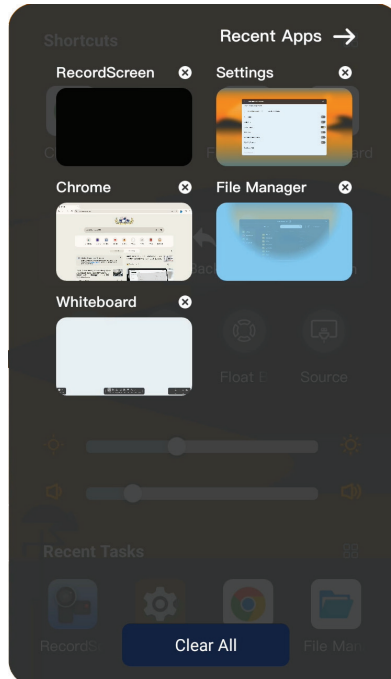



USING THE SYSTEM

4.3 Configuring System Settings

In Settings menu, you can configure various system settings.

To access the Settings menu, do the following:

- 1 On the Home screen, swipe the screen to the left/touch  >  or press  on the remote control.

The Settings menu opens.

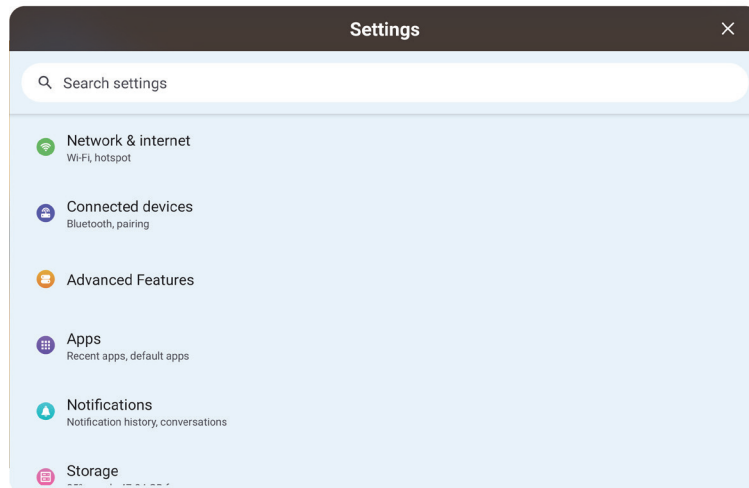

Note:

- ◆ For quick access of a specific setting, type the setting name in the Search bar on top of the menu.
- 2 Configure the following settings based on your needs:
Network & internet:
 - **Internet:** Connects to an available wireless access point. Enter the access password if prompted.
 - **Calls & SMS:** Not supported.
 - **Airplane mode:** Disables or enables all wireless signals.
 - **Wired network:** Connects to LAN through a wired connection.
 - **Hotspot & tethering:** Provides internet to other devices through your Wi-Fi connection. Apps can also create a hotspot to share content with nearby devices.
 - **Data Saver:** Data saver prevents some apps from sending or receiving data in the background. To help reduce data usage, enable data saver and select the apps that can use unrestricted data (if applicable).
 - **VPN:** Sets up and manages virtual private networks for safe and secure online communication.
 - **Private DNS:** Sets the private DNS mode. If enabled, then all DNS queries will be encrypted to prevent third parties from monitoring your online activity.

USING THE SYSTEM

Connected devices:

- **Other devices > USB:** Configures USB connection preferences.
- **Other devices > Pair new device:** Connects to other Bluetooth devices.

Advanced Features:

- **Automatic sleep:** Enables or disables automatic sleep. When there is no source signal, there is no operation within the specified time. The device automatically sleeps, and system shuts down.
- **Boot channel:** Enables or disables boot channel. If enabled, select the preferred boot channel.

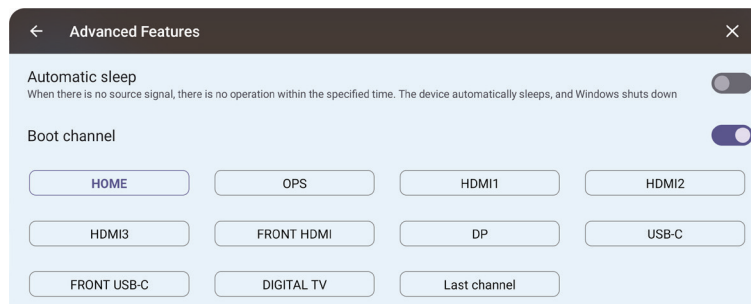

- **OPS boot:** Enables or disables booting from OPS source. Alternatively, you can set to boot from Any source.
- **Network wakeup:** Enables or disables the interactive display to turn on from the sleep mode by a network message (“magic packet”).
- **Source wakeup:** Enables or disables the interactive display to turn on from the sleep mode when it detects a source signal.
- **Slide menu:** Enables or disables the Slide menu icon >/< on the Home screen.
- **Select home page mode:** Sets the Home screen mode to **normal home page** or **google home page**.

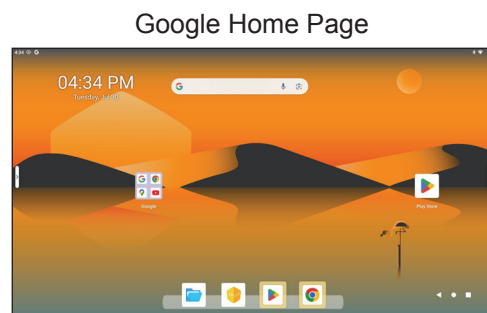
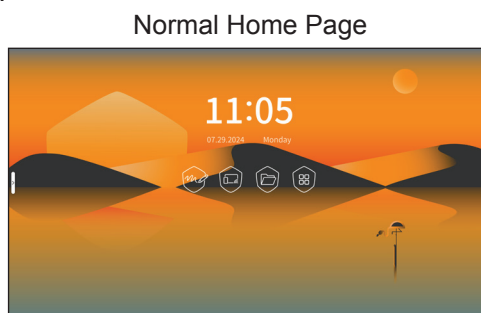

USING THE SYSTEM

Note:

- ◆ If you have set the **google home page** as the Home screen mode, then swipe down from the upper edge of the screen to view notifications, adjust brightness, access quick settings, and more.

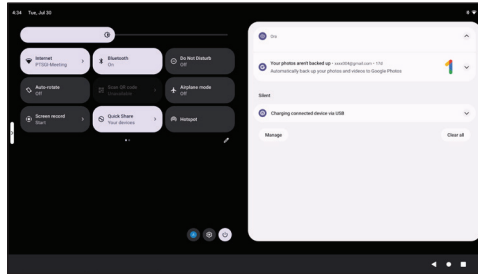

- ◆ If you have set the **google home page** as the Home screen mode, then swipe up from the bottom edge of the screen to quickly access the Apps screen.

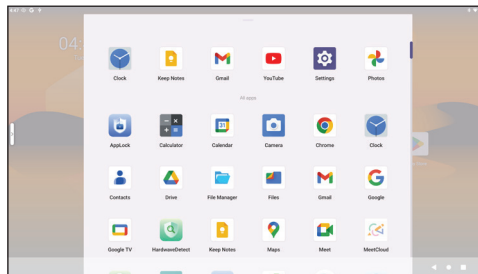

- **Boot time:** Sets the boot time.
- **Shut time:** Sets the shut down time.
- **Security Management:** Sets the security options of the device as follows: You can set a password to prevent from changing the setting without permission. Enter the 4-digit password at the prompt:

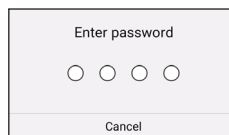

- **USB Lock:** Enables or disables reading data from connected USB devices.
- **App Installation Lock:** Enables or disables installing third-party apps to the interactive display.
- **SAMBA Service:** Enables or disables Samba service.
- **Reset options:** Resets the system.

Select the reset option based on your needs. The options are as follows:

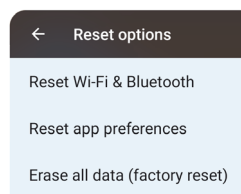

- **Reset Wi-Fi & Bluetooth:** Resets all network settings, including Wi-Fi and Bluetooth to the factory defaults.
- **Reset app preferences:** Resets app preferences to the factory defaults.

USING THE SYSTEM

- **Erase all data (factory reset):** Erases all data from your interactive display's internal storage, including your Google account, system and app data and settings, downloaded apps, music, photos, and other settings to the factory defaults.
- **Password Setting:** If password is created in **Security Management**, you can change the password setting here. The options are as follows:

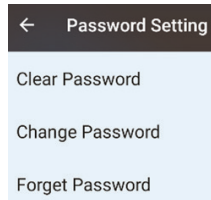

- **Clear Password:** Enter current password to clear password.
- **Change Password:** Enter current password and new password to change password.
- **Forget password:** Enter 6-digit super password to clear password. Please contact our customer service to have the super password.
- **Input Name Setting:** Enables or disables renaming input sources. To rename the input source, enable **Enter Alias Switch**. Then touch the input source you want to rename. Rename the source and touch **Save**.

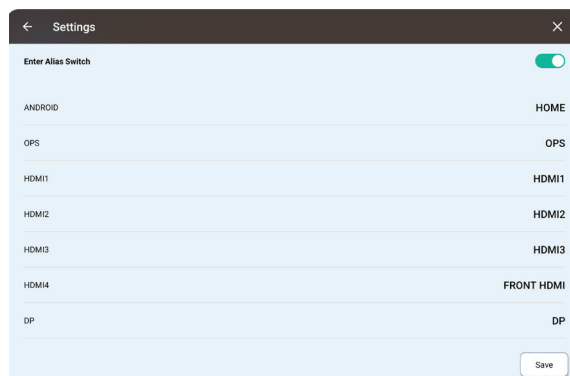

Apps:

- Manages apps that are installed to the interactive display. You can enable or disable the app, force stop it, manage storage, and more.
- **General > Default apps:** Sets the default apps.
- **General > Screen time:** Displays the activity statistics.
- **General > Unused apps:** Displays the unused apps.
- **General > Special app access:** Configures the special app access settings.

Notifications:

- **Manage > App Settings:** Controls notifications from individual apps.
- **Manage > Notification history:** Shows recent and snoozed notifications.
- **Conversation > Conversation:** Sets conversation priorities.
- **Conversation > Bubbles:** Enables or disables new conversations to appear as floating icons on top of other apps.

USING THE SYSTEM

- **Privacy > Device & app notifications:** Controls which apps and devices can read notifications.
- **Privacy > Notifications on lock screen:** Configures what type of notifications are displayed on the lock screen.
- **General > Do Not Disturb:** Enables or disables **Do Not Disturb** function. If enabled, then notifications are displayed only from selected people and apps.
- **General > Hide silent notifications in status bar:** Enables or disables hiding silent notifications in status bar.
- **General > Allow notification snoozing:** Enables or disables notification snoozing.
- **General > Notification dot on app icon:** Enables or disables showing a dot on app icon that has received a notification.
- **General > Enhanced notifications:** Informs about suggested actions, replies, and more.

Storage:

- Displays used and available storage in total and by a category.
- **Storage manager:** Enables or disables storage manager.
- **Free up space:** Enables to free up storage space via **Files** app.

Sound & vibration:

- Adjusts media, call, alarm, and notification volume.
- **Do Not Disturb:** Enables or disables **Do Not Disturb** function. If enabled, then notifications are displayed only from selected people and apps.
- **Live Caption:** Automatically captions speech.
- **Media:** Configures how media player is displayed.
- **Default notification sound:** Sets the default notification sound.
- **Default alarm sound:** Sets the default alarm sound.
- **Screen locking sound:** Enables or disables screen locking sound.
- **Charging sounds and vibration:** Enables or disables charging sound.
- **Touch sounds:** Enables or disables touch sound.
- **Always show icon when in vibrate mode:** Enables or disables showing the vibrate mode status icon in status bar.

Display:

- **Brightness > Brightness level:** Adjusts the screen brightness.
- **Brightness > Adaptive brightness:** Enables or disables adaptive brightness based on the environment illumination.
- **Lock display > Lock screen:** Configures what type of notifications are displayed on the lock screen.
- **Lock display > Screen timeout:** Sets the screen timeout time.

USING THE SYSTEM

- **Appearance > Dark theme:** Enables or disables dark theme.
- **Display size and text:** Configures the display and font sizes.
- **Colors > Colors:** Sets the color theme.
- **Other display controls:** Sets the screen saver, enables or disables motion sensor and temperature display.

Wallpaper:

To modify the Home screen wallpaper and style, long touch the Home screen.

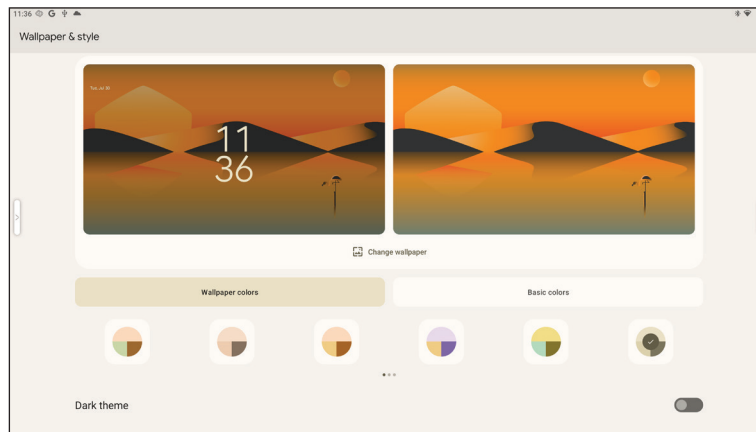

- **Change wallpaper:** Select a wallpaper for the Home screen.
- **Wallpaper colors:** Select one of the color combinations for wallpaper.
- **Basic colors:** Select one of the colors.
- **Dark theme:** Enable or disable dark background.

Accessibility:

- **Screen reader > Select to Speak:** Enables or disables hearing selected text.
- **Screen reader > TalkBack:** Enables or disables spoken feedback.
- **Display > Display size and text:** Configures the display and font sizes.
- **Display > Color and motion:** Sets the color theme.
- **Display > Magnification:** Enables or disable quickly zooming in on the screen to make the content larger.
- **Interaction controls > Timing controls:** Sets the touch and hold delay, accessibility timeout, and dwell timing.
- **Interaction controls > System controls:** Not applicable.
- **Captions > Live Caption:** Automatically captions media.
- **Captions > Caption preferences:** Customizes caption size and style to make them easier to read.
- **Audio > Audio description:** Enables or disables hearing a description of what is happening on the screen in supported movies and shows.
- **Audio > Audio adjustment:** Adjusts audio settings, such as mono audio and audio balance.

USING THE SYSTEM

- **General > Accessibility shortcuts:** Configures the accessibility shortcuts.
- **General > Text-to-speech output:** Configures the text-to-speech output settings.

Security:

- **Security status:** Displays Google Play Protect app scan time and status, enables or disables Find My Device feature, displays the latest security update and Google Play system update date and available updates.
- **Device security > Screen lock:** Sets the screen lock.
- **Device security > More security settings:** Configures advanced security settings, such as encryption, credentials, and more.

Privacy:

- **Privacy dashboard:** Displays apps that recently used permissions.
- **Permission manager:** Controls app access to your data.
- **Show passwords:** Enables or disables displaying characters briefly as you type.
- **Notifications on lock screen:** Configures what type of notifications are displayed on the lock screen.
- **Android System Intelligence:** Shows suggestions based on the people, apps, and content you interact with.
- **App content:** Enables or disables apps to send content to the Android system.
- **Show clipboard access:** Enables or disables showing a message when apps access text, images, or other content you have copied.
- **Autofill service from Google:** Manages saved passwords, credit cards, and addresses.
- **Activity controls:** Enables to choose the activities and info you allow Google to save.
- **Ads:** Manages ads personalization on the interactive display.
- **Usage & diagnostics:** Shares data to help improve Android.

Location:

- **Use location:** Enables or disables location detection.
- **Recent access:** Displays the recent apps that have used the location service, configures app location permissions, and other location services.

USING THE SYSTEM

Passwords & accounts:

- **Passwords:** Manages passwords.
- **Autofill service:** Configures autofill options.
- **Accounts:** Adds and manages accounts.
- **Automatically sync app data:** Enables or disables synchronizing app data automatically.

Digital Wellbeing & parental control: Configures screen time, app timers, bedtime schedules, and more.

Google: Configures Google services and preferences.

System:

- **Languages & input > Preferred Language:** Sets the preferred language of the system and the language for apps.
- **Languages & input > Keyboards:** Configures the on-screen and physical keyboard settings.
- **Languages & input > Speech:** Configures the settings of speech recognition and synthesis from Google and text-to-speech output settings.
- **Languages & input > Tools:** Enables or disables spell checker for Gboard, manages personal dictionary entries, and adjusts the pointer speed.
- **Gestures:** Configures gestures.
- **Date & time > Set time automatically:** Sets time automatically over Internet or manually.
- **Date & time > Time zone:** Sets the time zone automatically or manually.
- **Date & time > Time format:** Sets the time format.
- **Backup:** Backs up your data.
- **System update:** Displays the current system version and updates the system.
- **Multiple users:** Enables or disables multiple users and manages user accounts.

About Device: Displays and modifies the device name, displays legal information, model name, Android version, device identifiers, MAC and Bluetooth address, currently connected network type, and more.

- 3 Touch  to close the Settings menu.

CHAPTER 5: USING THE APPS

5.1 Accessing Apps

Some apps, such as **Whiteboard**, **Montage**, and **File Manager** are accessible directly from the Home screen. Other apps that are installed on the interactive panel, can be accessed through the Apps screen.

To access the Apps screen, do the following:

- 1 On the Home screen, swipe the screen to the left or touch 

The Apps screen opens.

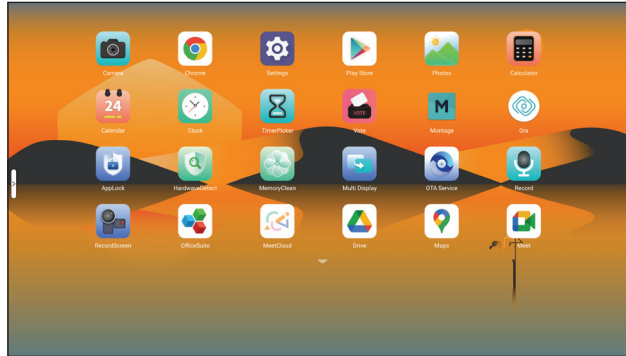

- 2 Swipe the Apps screen up or down to see all apps. To open an app, simply touch the app icon.

5.2 Whiteboard

Whiteboard is an interactive app that enables you to write and draw images on the display to demonstrate your ideas. The screen image can be saved to the device memory, connected portable disk, easily shared via QR code or email.

Note:

- ◆ To hold an online whiteboard session, use **Whiteboard** via **Montage**. For more information, refer to page 63.

To use **Whiteboard**, do the following:

- 1 Touch  on the Home screen or press  on the remote control.

Whiteboard opens.

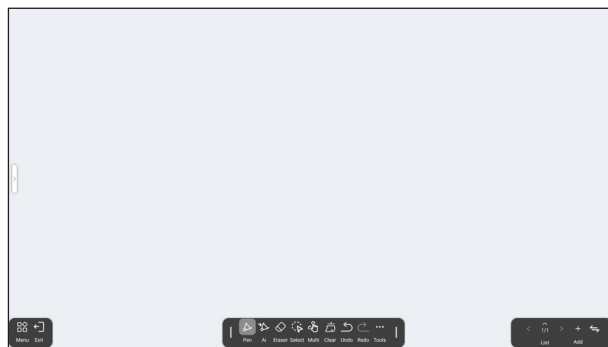

USING THE APPS

- 2 Write or draw directly on the whiteboard with the default settings for pen tip type (bottom & top tip), thickness, font color, and background color or touch any of the following icons to modify the default settings:

Note:

- ◆ You can relocate the options menu by holding it from either sides of the marked areas and dragging it to the left or to the right side of the screen.

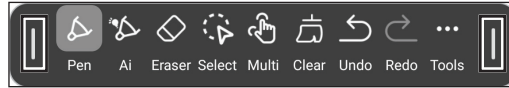

- **Pen:** Sets the pen type, tip, thickness, and font color for top tip and bottom tip.

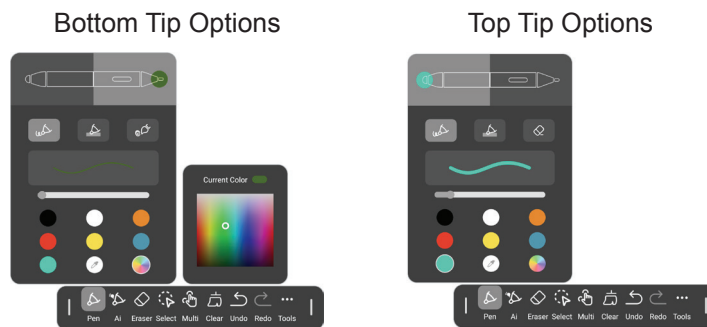

- **Ai:** Automatically detects the written text (🗨️) or drawn shape (📐) and digitize it. You can also change the text or shape color.

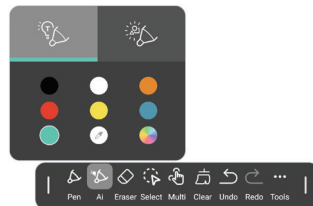



- **Eraser:** Deletes areas of your written text or shapes.
- **Select:** Selects your writing or drawing on the screen. You can then relocate it, rotate, copy/paste (📄), change color (🎨), and delete (🗑️) it.
- **Single/Multi:** Switch between single and multiple touch points. In single touch mode, it supports two or three-finger gesture controls. In multi-touch mode, it allows multiple fingers or pens to write simultaneously.
- **Clear:** Deletes all content on the screen.
- **Undo/Redo:** Undoes or redoes modifications respectively.
- **Tools:** Touch and of the following tools based on your needs:





- **Shape:** Add a shape, select its color and line width.
- **Text:** Add a text box, select the text color, enable or disable bold, tint, stretch, and more.
- **Form:** Add a form, select a number of rows, columns, and enable or disable audio adjustment

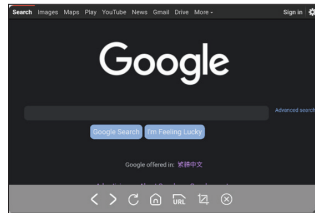

USING THE APPS

and binding of data. The number of rows and columns are not fixed, you can edit them later.

-  **Mind**: Add a diagram.
-  **Current page note**: Add a note.
-  **Web browser**: Add a fully functional web browser.



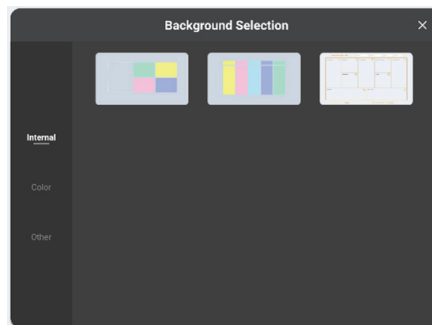

-  **Timer**: Add a timer.
-  **RecordScreen**: Start recording the screen.

- 3 Touch  **Menu** >  **Background** to change the background of the screen. Select the background pattern, color, or upload your own background.



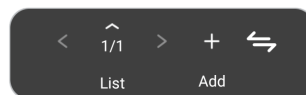

- 4 To add a new page, touch + **Add** in the page manager. You can also view all the pages of the session, move to a specific page, or delete an unnecessary page by touching **List** in the page manager. To swap the places of the page manager and the menu, touch .



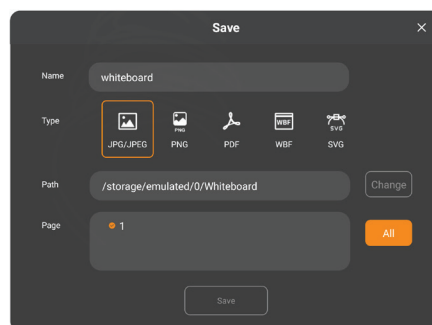

- 5 Touch  **Menu** >  **Save** to save the session. Name the session, select the format, path and page that you want to save, and touch **Save**.





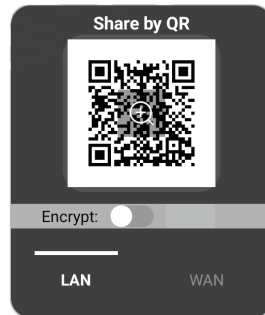





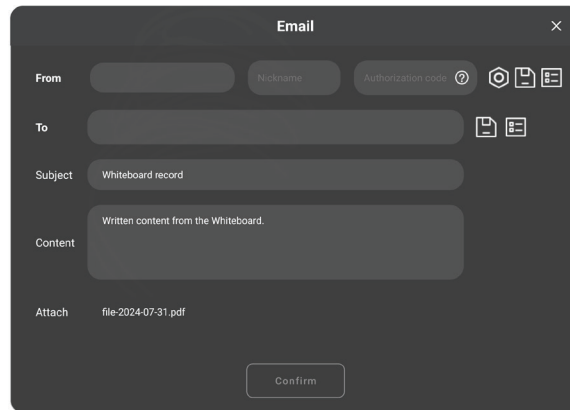

USING THE APPS

- 6 Touch  **Menu** >  **Share by QR** to share the session to other people who are connected to the same LAN or WAN with the interactive display. For enhanced security, enable the encrypt option (if necessary).



- 7 Touch  **Menu** >  **Email** to send the session by email. Fill out the required fields and touch **Confirm**.



- 8 Touch  **Menu** >  **Annotation** to use the annotation tool. For more information, refer to page 67.
- 9 Touch  **Menu** >  **Set as default** to set the current session as the default session.
- 10 Touch  **Menu** >  **About** to check the **Whiteboard** version.
- 11 Touch  **Menu** >  **Open** to open a previously saved session.
- 12 Touch  **Exit** to close **Whiteboard**.

USING THE APPS

5.3 Montage

Montage app enables to mirror the display's screen on your portable device for hands-on annotation, mirror the screen of your device on the display, or use your device as a remote control for the display.

Montage is accessible by downloading the **DisplayNote** app to your portable device or using the **DisplayNote** web app over a Chromium web browser. For sharing the screen of your portable device to the interactive display, use **AirPlay**, **Miracast**, or **Google Cast**.

Note:

- ◆ **DisplayNote** app is available for Windows, Mac, iOS, and Android operating systems.
- ◆ For the first-time setup of **Miracast**, please disconnect from any Wi-Fi networks but keep Wi-Fi enabled. Then, go to **Settings > Network & Connections** in **Montage** to turn on the Miracast receiver. Finally, reconnect to your Wi-Fi network.

To start casting the screen, do the following:

- 1 Install **DisplayNote** on your portable device or skip this step if you intend to use **DisplayNote** web app over a web browser.
- 2 Ensure that the interactive display is connected to the network and your portable device is connected to the same network.
- 3 On the Home screen, touch  to open **Montage**.
The launcher screen opens:

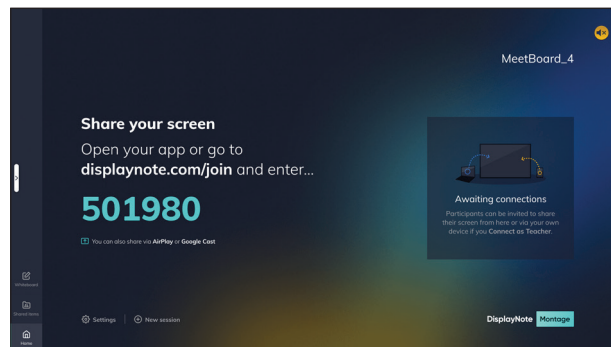

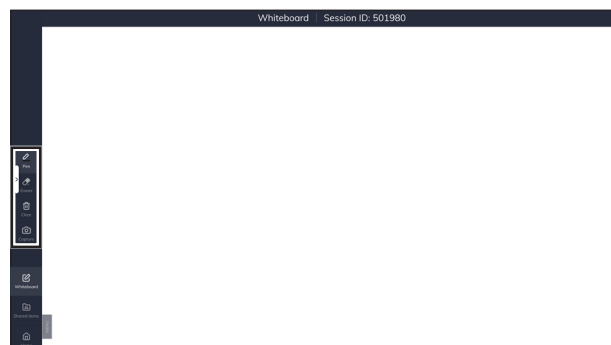

- 4 Touch any of the following items on the launcher screen based on your needs:
 -  **Whiteboard**: Start a shared whiteboard session. During the session, touch **MENU** to access the annotation tools.



-  **Shared items**: View items that are shared with you and share items to other attendees from the interactive display.

USING THE APPS

-  **Home:** Return to the launcher screen from any other screen.
-  **Settings:** Edit the room name, select the interface language, and view the device info.

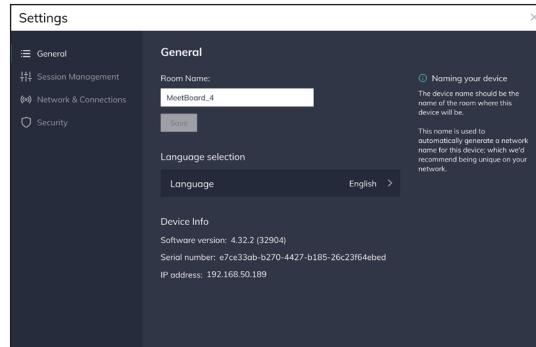

- 5 Launch **DisplayNote** on your portable device or open the web browser and enter “**displaynote.com/join**” without quotation marks and the numeric code that is displayed on the launcher screen. For example, “**501980**”.

Note:

- ◆ The following screenshots are captured from an iOS device when using the **DisplayNote** app.
- 6 Enter the session ID that is displayed on the launcher screen and your name. Then touch **Connect**.

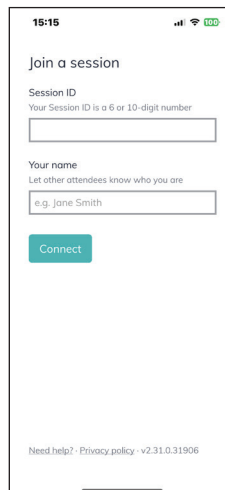

- 7 Touch any of the following:

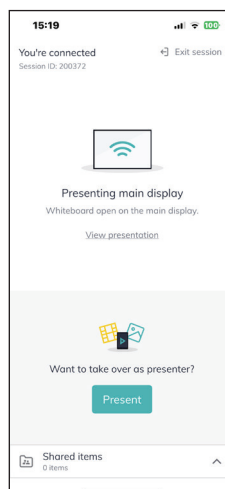

USING THE APPS

- **View presentation:** View the presentation on the main display, annotate the presentation screen, and capture a screenshot.

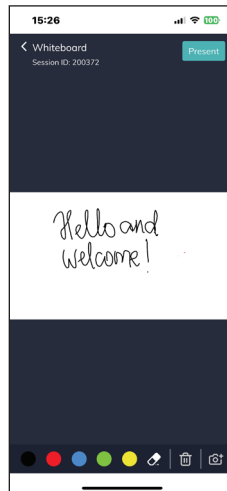

- **Present:** Share your portable device's screen or present a video from the gallery.

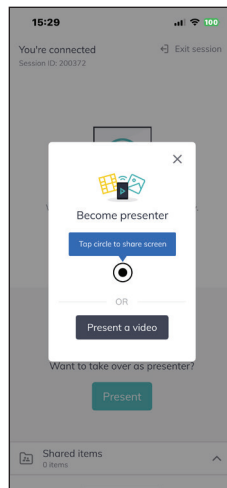

- **Shared items:** View and share items. Touch **+Add** to upload items for sharing or touch on the item to open it.

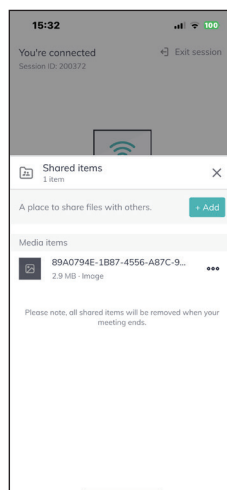







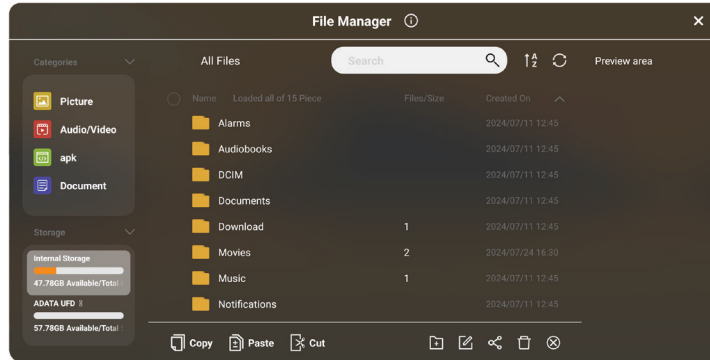





USING THE APPS

5.4 File Manager

File Manager enables you to manage files that are saved to the internal memory and to the connected external storages.



To access and manage your files, do the following:

- 1 On the Home screen, touch  to open **File Manager**.
- 2 Do any of the following based on your needs:
 - In the **Storage** section, touch the storage device where you want to manage files. You can also see the available and used space on the storage.
 - Enter a keyword to the search bar to look for a file.
 - Touch  and sort the files by name, size, time, or type.
 - Touch  to refresh the view.
 - In the **Categories** section, touch **Picture** to view all image files stored to the selected storage, **Audio/Video** to view all audio and video files, **apk** to view all installation files, and **Document** to view all documents.
 - To open the file, simply touch it. To select file(s), long touch a file first to enter the selection mode and then select files. If you want to select all files, touch . Then touch  **Copy** or  **Cut** to  **Paste** the files to your preferred location. Touch  to create a new folder,  to rename the selected file,  to share the file(s) via Bluetooth or email,  to delete the selected file(s), and  to close the file preview.

Note:

- ◆ You can set the image file as the Home screen wallpaper or insert it to the **Whiteboard** session directly from the File Manager. Long touch to select the image file and then touch **Set as wallpaper** or **Insert to whiteboard** respectively.
- 3 To access cloud drive and remote file storage, scroll down the right-side menu and select the **Cloud Disk Space** section. Follow the login instructions for each option, and you will be able to access your files.
 - 4 Press  to close the File Manager.

USING THE APPS

5.5 Annotation

Choose from a range of various tools with which to annotate the screen. To open **Annotation**, touch **Slide menu** >< > **Annotation**, or lift the pen from the device on any screen except for the Home screen.

Write or draw on the screen directly with your finger or with the touch pen. To change the text/drawing color, digitize text, automatically detect the drawing, and more, use any of the following annotation tools based on your needs:



Touch any of the following based on your needs:

- : Minimizes the annotation toolbar and drags it to your preferred location on the screen.
- : Sets the pen tip type (bottom & top tip), thickness, and font color for top tip and bottom tip.

Bottom Tip Options



Top Tip Options



- : Automatically detects the written text () or drawn shape () and digitizes it. You can also change the text or shape color.

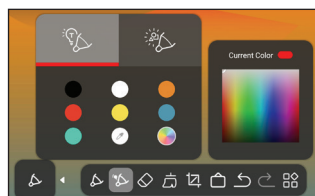

- : Deletes areas of your written text or shapes.
- : Deletes all annotations on the screen.
- : Copies the screen image. Touch to automatically paste it to **Whiteboard**.
- or : Undoes or redoes modifications respectively.

USING THE APPS

-  Saves, shares, or sends the screen image by email. You can also temporary stop or exit the writing mode.

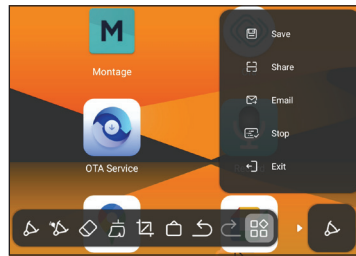

5.6 ScreenShot

Captures the screen image. To open **ScreenShot**, touch **Slide menu** >< > **ScreenShot**.

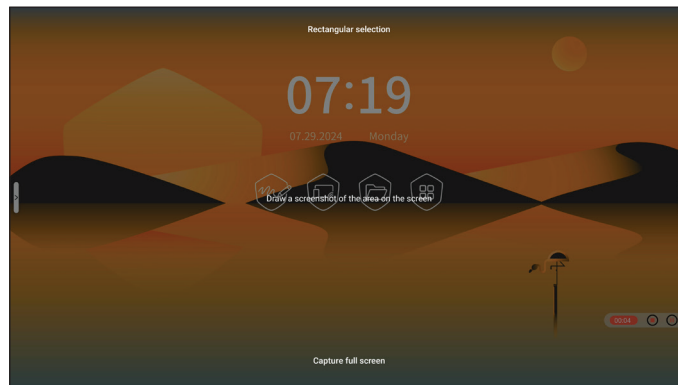

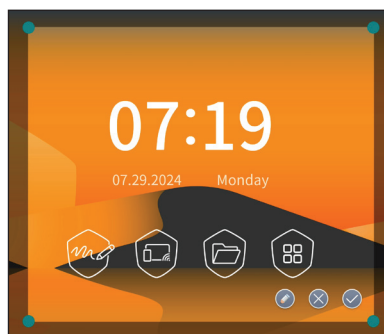

Select an area on the screen or the full screen.

- If you want to select an area on the screen, then draw an invisible rectangle around that area. The area will be automatically marked. For example:



Note:

- ◆ You can enlarge or shrink the marked area by dragging the boundary points outwards or inwards respectively.

Touch  to open the selected area in **Whiteboard**,  to suspend the screen capture, or  to save the screenshot to the local storage.

- If you want to capture the entire screen, then touch the wording "**Capture full screen**" on the bottom of the screen. The screenshot will be saved to the local storage.

CHAPTER 6: APPENDIX

6.1 Warning Messages

Warning Messages	Cause	Solution
	The resolution or the refresh rate of the graphics card of the computer is set too high.	<ul style="list-style-type: none"> • Change the resolution or the refresh rate of the graphics card.
	The interactive display cannot detect the input source signal.	<ul style="list-style-type: none"> • Check if the input source is turned ON. • Check if the signal cable is properly connected. • Check if any pin inside the cable connector is twisted or broken.

6.2 Supported Media Formats

Video Format

Video Codec
AV1(AOMedia Video 1)
FLV1(Flash Video Sorenson H.263)
FLV1(Sorenson Spark)
H.263
H.264(AVC,AVC1)
H.265(HEVC)
MJPEG(Motion Joint Photographic Experts Group)
MPEG-1(VCD)
MPEG-2(DVD)
MPEG-4 Visual(M4S2)
MPEG-4 Visual(Xvid)
VP8(On2 VP8)
VP9
WMV3(VC-1,Windows Media Video 9)

APPENDIX

Audio Format

Audio Codec
AAC LC(Advanced Audio Coding Low Complexity)
AMR NB(Narrow band)
AMR WB(Wide band)
MIDI
MP2(MPEG Audio layer2)
MP3(MPEG Audio layer3)
FLAC
PCM S8VX
PCM S16 LE
PCM S16 BE
PCM S24 LE
PCM S32 LE
LPCM(PCM A-Law G.711)
LPCM(PCM μ -Law G.711)
IMA ADPCM
MS ADPCM
WMA V8
WMA9

Image Format

File Extension
.bmp
.jpeg
.jpg
.png

Note:

- ◆ Sound or video may not work if the contents have a standard bit rate/frame rate above the compatible Frame/sec listed in the table above.
- ◆ Video content with a Bit rate or Frame rate larger than the rate specified in the table above can cause choppy video during playback.

APPENDIX

6.3 Supported Resolution

Timing	fh (kHz)	fv (hz)	Pixel Freq (Mhz)	HDMI1	HDMI2/3 FR HDMI	DP	TypeC FR TypeC
VESA							
VGA	640 x 480	31.469	59.94	25.175	O	O	O
SVGA	800 x 600	37.879	60.317	40	O	O	O
XGA	1024 x 768	48.363	60	65	O	O	O
QXGA	1280 x 960	60	60	108	O	O	O
FHD	1920 x 1080	37.5	60	148.5	O	O	O
UHD	3840 x 2160	67.5	30	297	O	O	O
UHD	3840 x 2160	135	60	594	N/A	O	O
SD							
480P	60 Hz	31.469	59.94	27	O	O	O
576P	50 Hz	31.25	50	27	O	O	O
720P	50 Hz	37.5	50	74.25	O	O	O
	60 Hz	45	60	74.25	O	O	O
1080P	30 Hz	33.75	30	74.25	O	O	O
	50 Hz	56.25	50	148.5	O	O	O
	60 Hz	66	60	148.5	O	O	O
UHD							
2160p	30 Hz	67.5	30	297	O	O	O
	50 Hz	112.5	50	594	N/A	O	O
	60 Hz	135	60	594	N/A	O	O

Note:



- ◆ O: Supported
- ◆ N/A: Not supported

General guidelines:



- The PC text quality is optimum in HD 1080 mode (1920 x 1080, 60 Hz).
- Your PC display screen might appear different depending on the manufacturer (and your particular version of Windows).
- Check your PC instruction book for information about connecting your PC to a display.
- When horizontal synchronous signals seem irregular in RGB mode, check PC standby mode or cable connections.
- The display settings table complies to the IBM/VESA standards, and based on the analog input.
- The best timing for the vertical frequency to each mode is 60 Hz.

APPENDIX

6.4 Troubleshooting

Symptom	Possible Cause	Remedy
No picture is displayed	<ul style="list-style-type: none"> The power cord has been disconnected. The main power switch on the bottom of the display is not switched on. The selected input has no connection. The display is in standby mode. 	<ol style="list-style-type: none"> 1 Plug in the power cord. 2 Make sure the power switch is switched on. 3 Connect a signal connection to the display.
Interference displayed on the display or audible noise is heard	Caused by surrounding electrical appliances or fluorescent lights.	Move the display to another location to see if the interference is reduced or connect the display to another power outlet.
Color is abnormal	The signal cable is not connected properly.	Make sure that the signal cable is attached firmly to the display.
Picture is distorted with abnormal patterns	<ul style="list-style-type: none"> The signal cable is not connected properly. The input signal is beyond the capabilities of the display. 	<ul style="list-style-type: none"> Make sure that the signal cable is attached firmly. Check the video signal source to see if it is beyond the range of the display. Please verify its specifications with this display's specification section.
Display image doesn't fill up the full size of the screen	The picture format is not set correctly.	Open the Source menu and try the different aspect ratio formats. Refer to the "3.2 Selecting the Input Source Signal" section.
Can hear sound, but no picture	Improperly connected source signal cable.	Make sure that both video inputs and sound inputs are correctly connected.
Can see picture but no sound is heard	<ul style="list-style-type: none"> Improperly connected source signal cable. Volume is turned all the way down. Mute function is turned on. No external speaker connected. 	<ul style="list-style-type: none"> Make sure that both video and sound inputs are correctly connected. Press the  button on the remote control to hear the sound. Switch the mute function off by pressing the  button on the remote control. Connect the external speakers and adjust the volume to a suitable level.
Some picture elements do not light up	Some pixels of the display may not turn on.	This display is manufactured using an extremely high level of precision technology: however, sometimes some pixels of the display may not display. This is not a malfunction.

APPENDIX

Symptom	Possible Cause	Remedy
The response of the system is slow or the system crashes	<ul style="list-style-type: none"> Too many apps are running in the background. The normal operation of the system is disturbed by the environmental conditions, for example thunderstorm. 	Disconnect your interactive display from the power outlet and wait for 1-2 minutes. Then reconnect the power cable and restart the display.
The touch response is slow and not functioning	Too many apps are running in the background.	<ul style="list-style-type: none"> Close the apps that you are not using. Then touch  > MemoryClean  to clear cache. Restart the system.

6.5 Transporting the Interactive Display

To transport the interactive display for repair or shipment, place the display in its original packaging carton.

- 1 Use two persons to lift the interactive display (a).



Warning:

- ◆ Do not press too hard on the interactive display or edge of the frame, as this may cause the device to malfunction.
- 2 Place the interactive display inside the lower foam cushion in the lower box.
 - 3 Place the accessories on the designated area inside the box (if necessary).
 - 4 Place the upper box (b) on the interactive display.
 - 5 Tape the box (d).

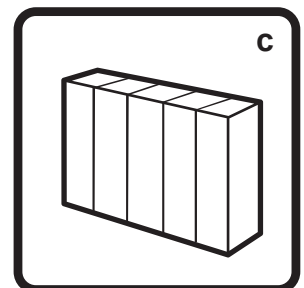
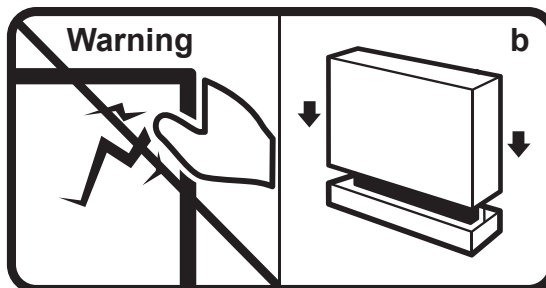
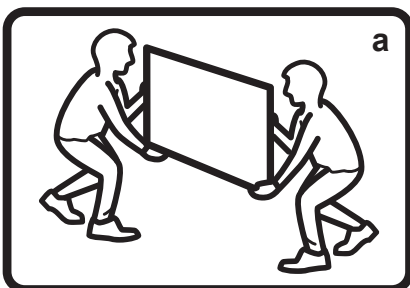

CHAPTER 7: SPECIFICATIONS

7.1 Display Specifications

IFP6504E-AE		
Panel	Panel Type	LED-Backlit TFT LCD (VA Technology)
	Panel Size	64.5"
	Max. Resolution	UHD 3840 x 2160
	Pixel Pitch	0.372 mm
	Brightness	400 cd/m ²
	Contrast Ratio	4000:1
	Viewing Angle (H/V)	178°/178°
	Display Colour	1.07G
	Response Time	5 ms
	Surface Treatment	Anti-Glare Treatment (Haze25%),3H Hard Coating
Frequency (H/V)	H Freq.	28 kHz-140 kHz
	V Freq.	50 Hz-75 Hz
Input	DisplayPort	1.2 x 1
	HDMI	1.4 x 1 / 2.0 x 3
	Type-C	Type-C x 1 (PD:65W) / Type-C x 1 (PD:15W)
Output	HDMI	2.0 x 1
External Control	RS232 In	9-Pin D-Sub
	LAN	RJ45 x 2
Other Connectivity	USB	2.0 x 1 , 3.0 x 4 (Service Port / Media Playback)
	OPS Slot	Yes
	Micro SD Card Slot	Yes
Audio	Audio In	Microphone (3.5 mm)
	Audio Out	Stereo Audio Jack (3.5 mm), S/PDIF
	Internal Speakers	15W x 2
Touch Screen	Technology	Infrared Touch Frame
	Positional Accuracy	±1.0 mm (90% area)
	Panel Interface	USB (Type-B) 2.0 x 1/USB (Type-B) 3.0 x 1
	Single Touch Plug & Play	Windows XP/Linux (kernel 18.04.1)/MAC OS (10.14)/Chrome (73.0.3683.114, 64bit)
	Multi-touch Plug & Play	40-point touch for Windows 11/10/8/7/Android
Power	Power Supply	Internal
	Power Requirements	AC 100-240V, 50/60 Hz
	On Mode	150W (On)
	Stand-by Mode	< 0.5W
	Off Mode	0W
Glass	Thickness	4mm
	Reflection Rate	≤ 8%
	Transmission Rate	≥ 88%
	IK Rating	≥ 9H
	Gloss	75±10%
	Haze	5-11%
Operating Conditions	Temperature	0°C-40°C (32°F-104°F)
	Humidity	10%-90% (non-condensing)
Storage Conditions	Temperature	-20°C-60°C (-4°F-140°F)
	Humidity	10%-90% (non-condensing)
Mounting	VESA FPM PMI	Yes (500 x 400 mm)

SPECIFICATIONS

Dimensions	Product with Bracket (W x H x D)	1485.0 x 897.0 x 119.1 mm (58.5" x 35.3" x 4.69")
	Product w/o Bracket (W x H x D)	1485.0 x 897.0 x 88.1 mm (58.5" x 35.3" x 3.47")
	Packaging (W x H x D)	1645.0 x 1050.0 x 192.0 mm (64.8" x 41.3" x 7.56")
Weight	Product with Base	40.9 kg (90.2 lb)
	Product w/o Base	38.1 kg (84.0 lb)
	Packaging	49.9 kg (110.0 lb)

Note:

- ◆ All specifications are subject to change without prior notice.

7.2 Display Dimensions

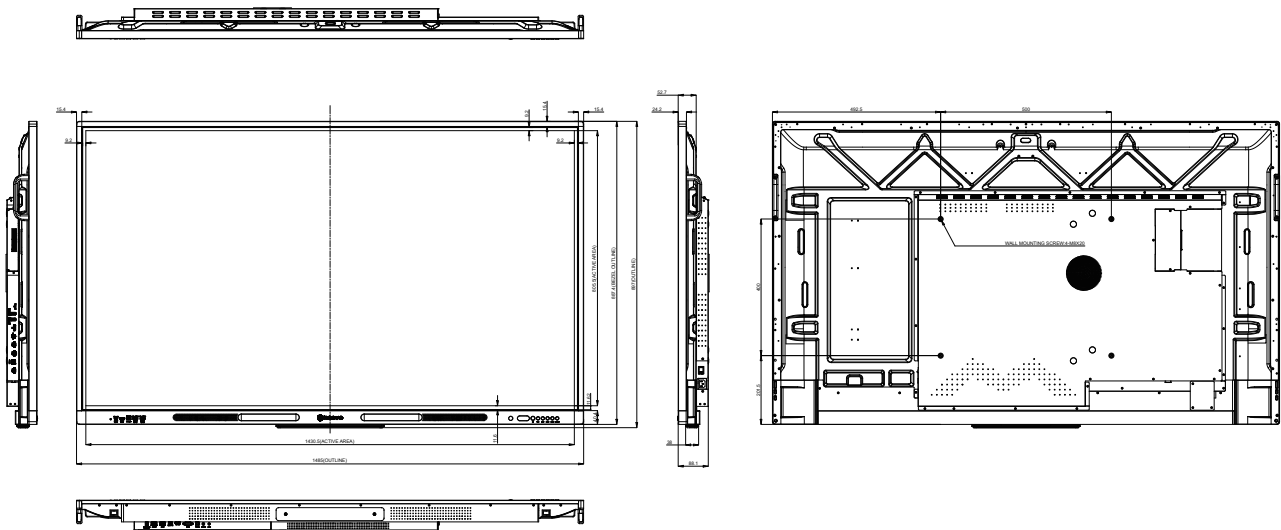

AG Neovo

Company Address: 5F-1, No. 3-1, Park Street, Nangang District, Taipei, 11503, Taiwan.

Copyright © 2024 AG Neovo. All rights reserved.

I654A0_UM_V010