

SC-2203

Net weight : 2.6kg(with stand)  
2.3kg(w/o stand)

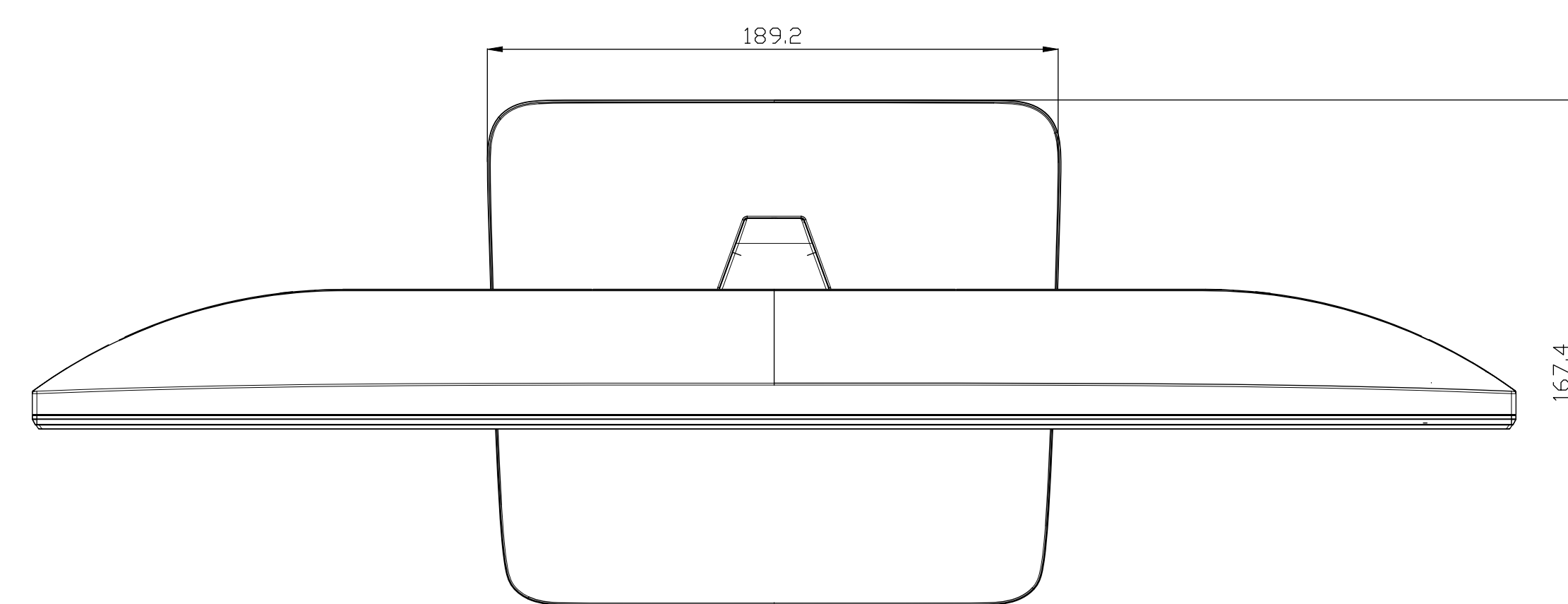
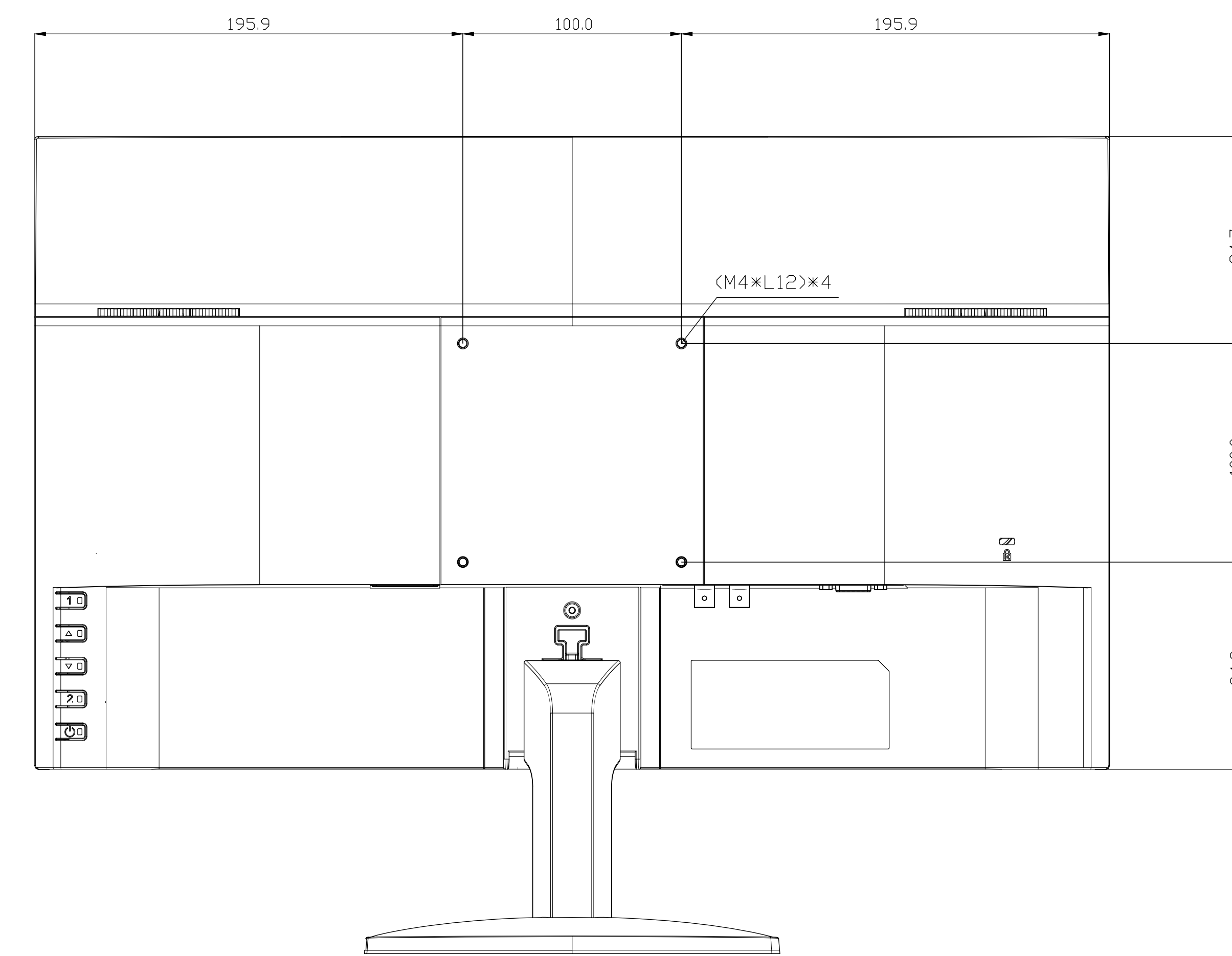
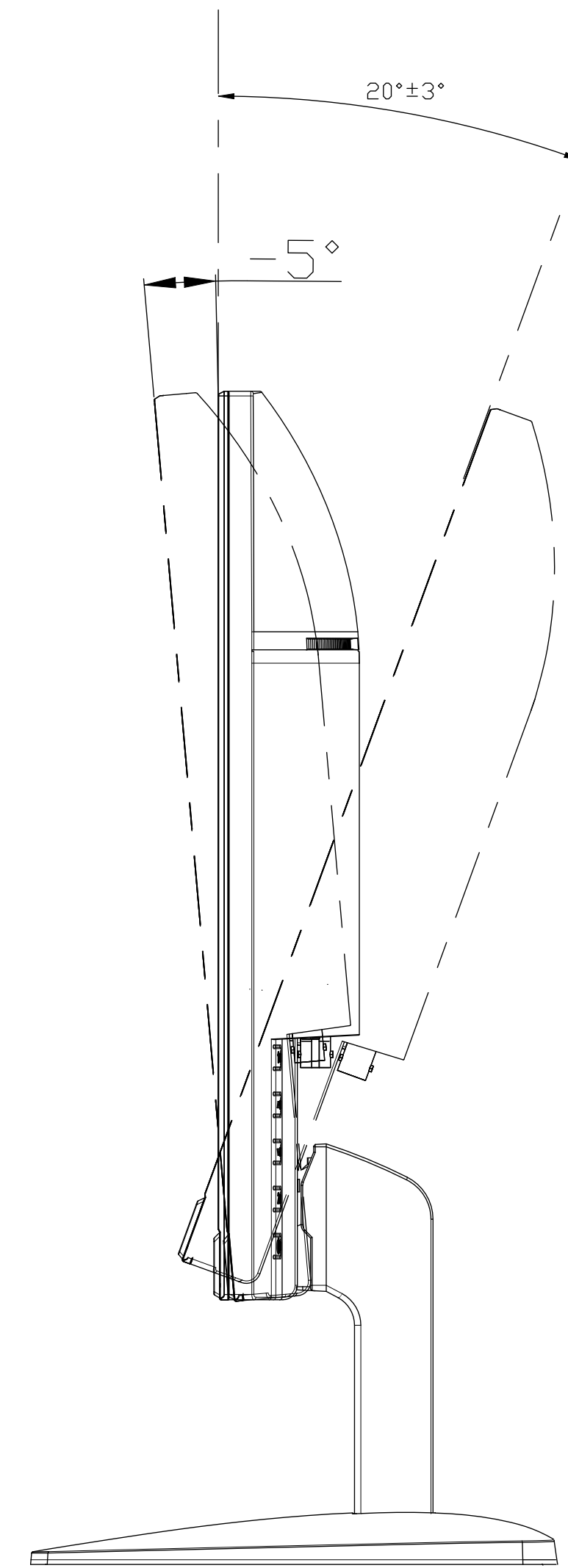
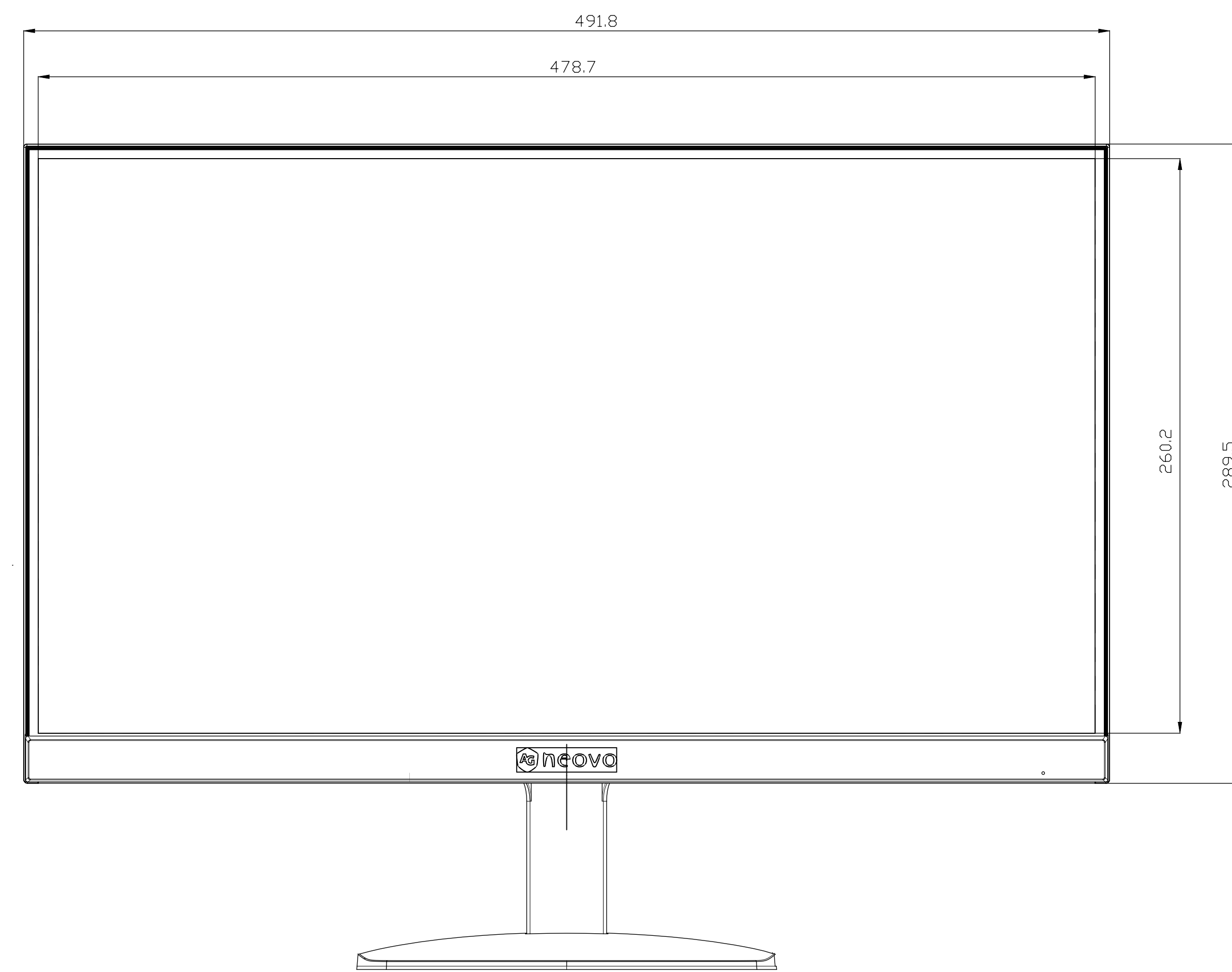
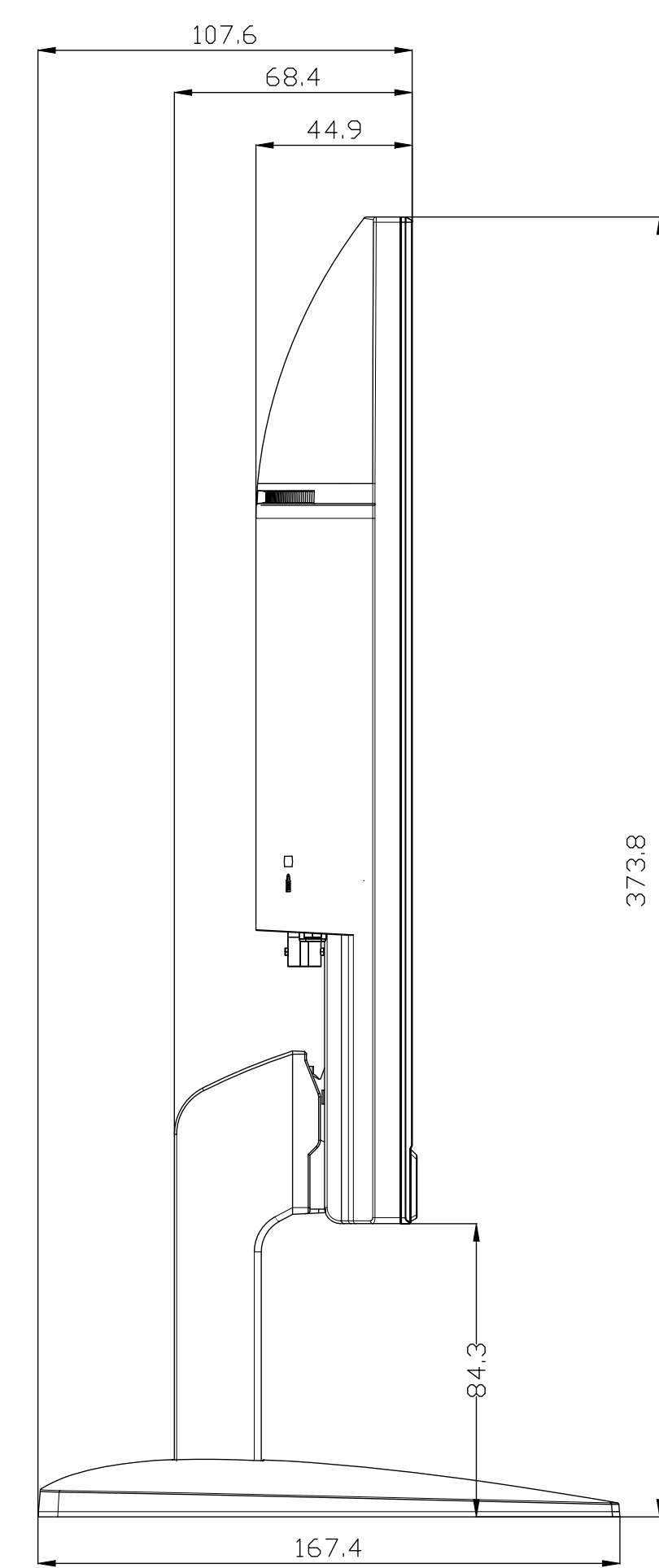
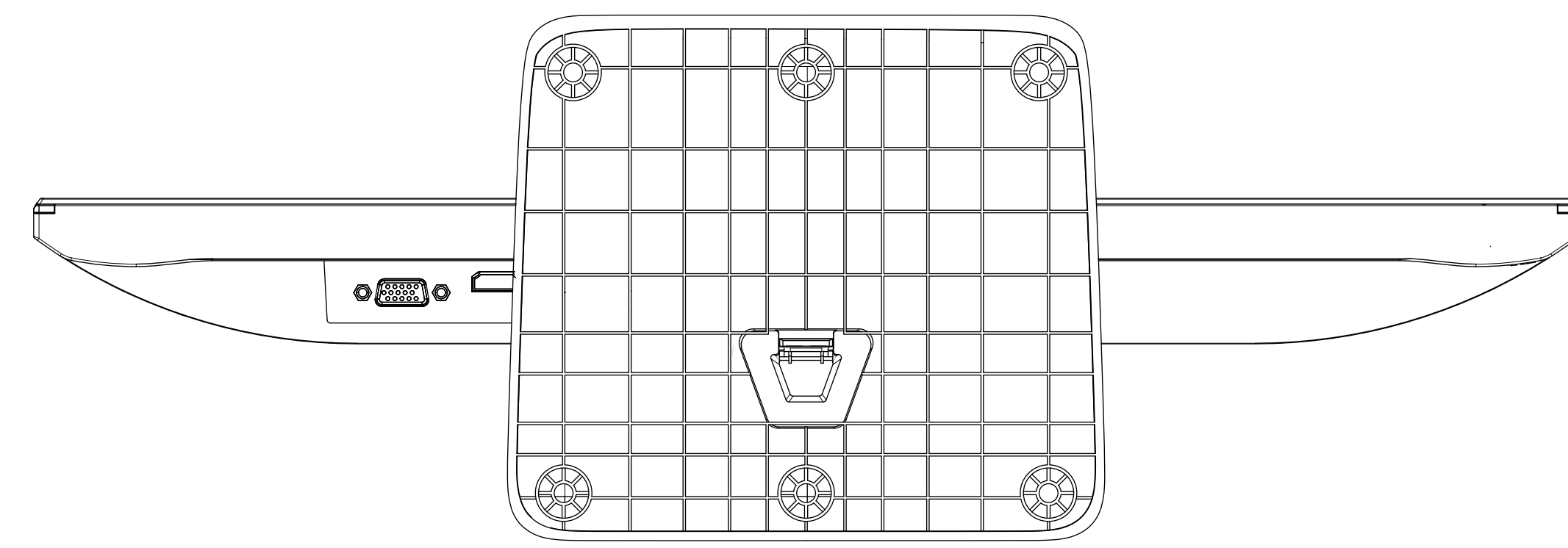

SCALE: 3/1

SPECIFICATIONS SUBJECT TO CHANGE WITHOUT NOTICE.

**AG neovo** [www.agneovo.com](http://www.agneovo.com)

Model Name:  
**SC-2203**

THIS DRAWING ON THIS PRINT AND INFORMATION BELONG WITH AG Neovo.  
ANY REPRODUCTION IN PART OR WHOLE WITHOUT WRITTEN PERMISSION  
OF AG Neovo IS PROHIBITED.

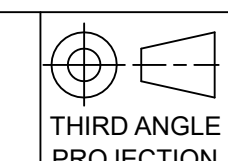

P/N:SC2230

SCALE 1:1 UNITS mm V.1.00