



THE DISPLAY CHOICE
OF PROFESSIONALS™

www.agneovo.com

N1651 OLED Portable Monitor
User Manual

TABLE OF CONTENTS

SAFETY INFORMATION	1
SAFETY PRECAUTIONS	2
CHAPTER 1: PRODUCT DESCRIPTION	3
1.1 Package Contents	3
1.2 Product Overview	4
Front and Left Side View	4
Rear and Right Side View	4
I/O Ports	4
CHAPTER 2: MAKING CONNECTIONS	5
2.1 Connecting to Power	5
2.2 Connecting External Devices	6
2.3 Power Delivery	7
Powering a Notebook or Mobile Phone.....	7
Power Delivery - Further Information	8
CHAPTER 3: ON SCREEN DISPLAY MENU	9
3.1 Adjusting the Viewing Angle	9
Tilt Angle Adjustment.....	9
3.2 Turning the Device On/Off.....	10
Using the Arrow Key.....	10
Quick Menu	11
Hot Keys.....	12
3.3 Configuring the Settings	13
General Operations.....	13
On-Screen Display (OSD) Menu Tree.....	15
CHAPTER 4: APPENDIX	17
4.1 Warning Message.....	17
4.2 Supported Resolutions	18
4.3 Cleaning	19
4.4 Troubleshooting.....	20
CHAPTER 5: SPECIFICATIONS	24
5.1 Monitor Specifications	24
5.2 Monitor Dimensions.....	25

SAFETY INFORMATION

Waste Electrical and Electronic Equipment-WEEE

Attention users in European Union private households

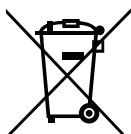

Disposal of Waste Equipment by Users in Private Household in the European Union.

This symbol on the product or on its packaging indicates that this product must not be disposed of with your other household waste. Instead, it is your responsibility to dispose of your waste equipment by handing it over to a designated collection point for the recycling of waste electrical and electronic equipment. The separate collection and recycling of your waste equipment at the time of disposal will help to conserve natural resources and ensure that it is recycled in a manner that protects human health and the environment. For more information about where you can drop off your waste equipment for recycling, please contact your local city office, your household waste disposal service or the shop where you purchased the product.

For Private Households in the European Union. To help conserve natural resources and ensure the product is recycled in a manner that protects human health and the environment, we would like to bring your attention to the following:

- The crossed-out dustbin on the device or outer packaging indicates the product is compliant with European WEEE (Waste Electrical and Electronic Equipment) Directive.
- Always dispose of the old devices separately from household waste.
- Batteries should be removed beforehand and disposed separately to the right collection system.
- You are responsible with regard to the deletion of personal data on old devices before disposal.
- Private households can hand in their old devices free of charge.
- For more information about where you can drop off your waste equipment for recycling, please contact your local city office, your household waste disposal service or the shop where you purchased the product.

Turkey RoHS

Türkiye Cumhuriyeti: EEE Yönetmeliğine Uygundur.

Ukraine RoHS

Обладнання відповідає вимогам Технічного регламенту щодо обмеження використання деяких небезпечних речовин в електричному та електронному обладнанні, затвердженого постановою Кабінету Міністрів України від 3 грудня 2008 № 1057.

SAFETY PRECAUTIONS

- Read these instructions completely before using the equipment.
- Keep these instructions in a safe place.
- Heed all warnings and follow all instructions.
- Sit at least 18" / 45 cm from the monitor.
- When installing the monitor, please leave 4" / 10 cm of open space around the monitor for ventilation safety purposes.
- Always handle the display with care when moving it.
- Always use cabinets or stands or installation methods recommended by the manufacturer of the monitor set.
- Always use furniture that can safely support the monitor.
- Always ensure the monitor is not overhanging the edge of the supporting furniture.
- Do not place the monitor where children are likely to be present.
- Always educate children about the dangers of climbing on furniture to reach the monitor or related equipment.
- Always route and manage cords and cables connected to your monitor so they cannot be tripped over, pulled, or grabbed.
- Exercise caution when removing the rear cover of the monitor. This monitor contains high-voltage parts.
- Do not use this equipment near water. To reduce the risk of fire or electric shock, do not expose the monitor to rain or moisture.
- Avoid exposing the monitor to direct sunlight or other sources of sustained heat. Do not install near any heat sources such as radiators, heat registers, stoves, or other devices (including amplifiers) that may increase the temperature of the monitor to dangerous levels.
- Clean with a soft, dry cloth. If further cleaning is required, see the "Maintenance" section in this guide for further instructions.
- Avoid touching the screen. Skin oils are difficult to remove.
- Do not touch, rub, or apply pressure to the monitor screen, as it may permanently damage the screen.
- Do not place the monitor in an unstable location.
- Do not place the monitor on tall furniture (for example, cupboards or bookcases) without anchoring both the furniture and the monitor to a suitable support.
- Do not place the monitor on cloth or other materials that may be located between the product and supporting furniture.
- Place the monitor in a well-ventilated area. Do not place anything on the display that prevents heat dissipation.
- Do not place heavy objects on the display, video cable, or power cord.
- Do not place items that might tempt children to climb, such as toys and remote controls, on the top of the monitor or furniture on which the product is placed.
- If smoke appears, an abnormal noise, or a strange odor is present, immediately switch the display off and contact your dealer or ViewSonic. It is dangerous to continue using the display.
- Do not attempt to circumvent the safety provisions of the polarized or grounding-type plug. A polarized plug has two blades with one wider than the other. A grounding type plug has two blades and a third grounding prong. The wide blade and the third prong are provided for your safety. If the plug does not fit into your outlet, obtain an adaptor and do not attempt to force the plug into the outlet.
- Please confirm the distribution system installed in the building. The system should provide a circuit breaker rated at 120/240V, 20A.
- When connecting to a power outlet, DO NOT remove the grounding prong. Please ensure grounding prongs are NEVER REMOVED.
- Protect the power cord from being treaded upon or pinched, particularly at the plug, and at the point where it emerges from the equipment. Be sure that the power outlet is located near the equipment so that it is easily accessible.
- Only use attachments/accessories specified by the manufacturer.
- Use only with the cart, stand, tripod, bracket, or table specified by the manufacturer, or sold with the equipment. When a cart is used, use with caution when moving the cart/equipment combination to avoid injury from tipping over.
- Unplug this equipment when it will be unused for long periods of time.
- Refer all servicing to qualified service personnel. Service will be required when the unit has been damaged in any way, such as: if the power-supply cord or plug is damaged, if liquid is spilled onto or objects fall into the unit, if the unit is exposed to rain or moisture, or if the unit does not operate normally or has been dropped.
- Excessive sound volume from ear-/headphones may cause hearing damage/ hearing loss.
- Adjustment of the volume control as well as the equalizer may increase the ear-/ headphones output voltage and therefore, the sound volume level.
- The factors influencing the ear-/headphones output other than those specified by the manufacturer (e.g. operating system, equalizer software, firmware, driver) may increase the ear-/headphone output voltage and therefore, the sound volume level.
- Stability Hazard: The display may fall, causing serious personal injury or death. To prevent injury, this display must be securely attached to the floor/wall in accordance with the installation instructions.
- If the existing monitor is going to be retained and relocated, the same considerations as above should be applied.

CHAPTER 1: PRODUCT DESCRIPTION

1.1 Package Contents

When unpacking, check if the following items are included in the package. If any of them is missing or damaged, contact your dealer.

Portable monitor

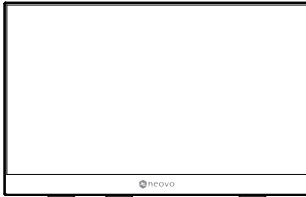

Power Adapter

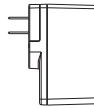

Quick Start Guide



USB Type C cable

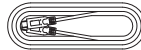

Mini HDMI to HDMI cable

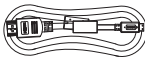

Protective bag cable



Note:

- ◆ *The power adapter and video cables included in your package may vary depending on your country. Please contact your local reseller for more information.*

PRODUCT DESCRIPTION

1.2 Product Overview

Front and Left Side View

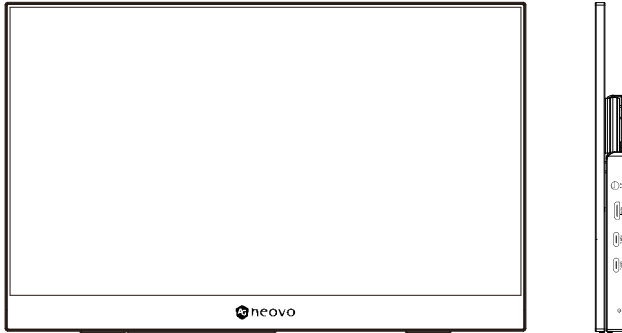

Rear and Right Side View

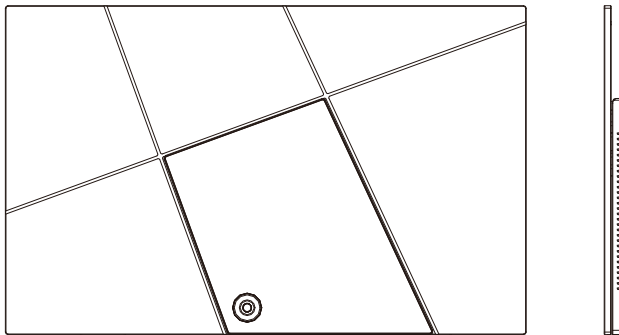

I/O Ports

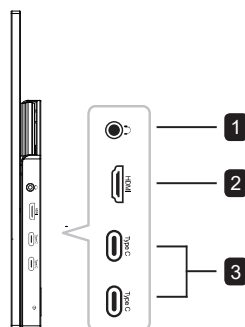

1 Audio Out

2 Mini HDMI

3 USB Type C

Note:

- ◆ For more information about the arrow Key and its functions, refer to “Hot Keys”
- ◆ Does not support simultaneous input signals from two TYPE C ports

CHAPTER 2: MAKING CONNECTIONS

2.1 Connecting to Power

The monitor can be powered in any of the following configurations:

• Type C Connection

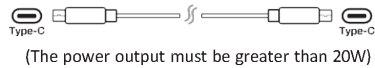

• Power Adapter

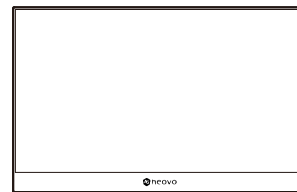
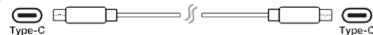
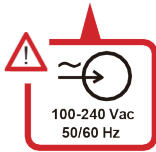

Note:

- ◆ For more information, please see "Power Delivery"

MAKING CONNECTIONS

2.2 Connecting External Devices

Your external device(s) can be connected in any of the following configurations:

• Type C Connection

Connect a Type C cable from your external device to a **Type C** port on the monitor.

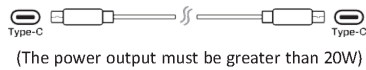

• Mini HDMI Connection

Connect the HDMI port from your external device to the mini **HDMI** port on the monitor.

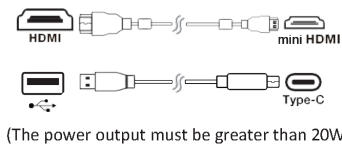

Note:

- ◆ When using Mini HDMI to connect external devices, you need to use a Type C interface for power supply. The power output must be greater than 20W.

MAKING CONNECTIONS

2.3 Power Delivery

Powering a Notebook or Mobile Phone

If the included power adapter is connected to the monitor, then the monitor can charge a connected notebook or mobile phone.

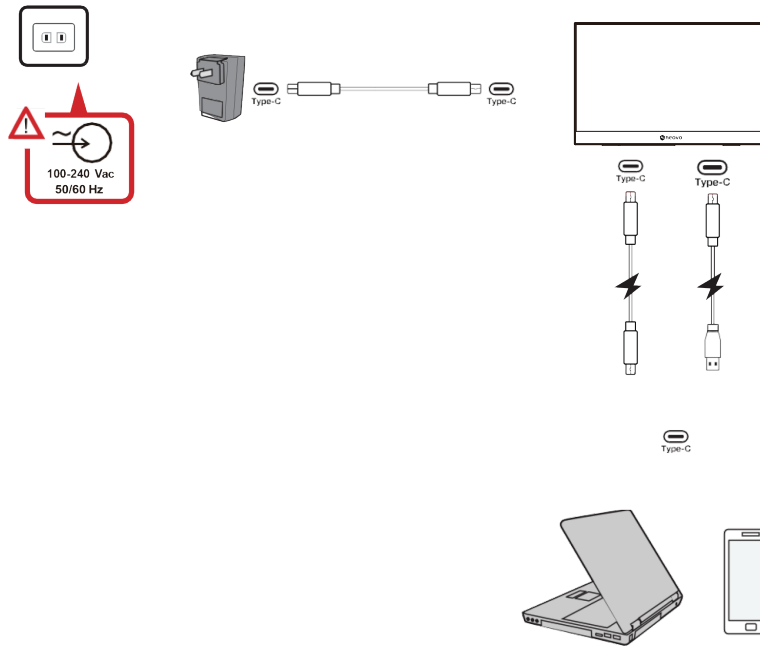

Note:

- ◆ Power Delivery Output: DC 5V/9V/12V/15V/20V/Max 3A.

MAKING CONNECTIONS

Power Delivery - Further Information

Due to the N1651 OLED's design please note:

- The first connected device will be the main input signal.
- When a Type C port recognizes an external device as a power adapter, it will only distribute the power. It will NOT display the input signal.
- Only when one of the Type C ports is recognized as a power adapter can the other one deliver two-way power.

If a laptop is connected first to the N1651 OLED, then a mobile phone is connected second, the mobile phone's battery will not be charged as neither Type C port recognizes the connection as being connected to a power adapter.

NOTE: If you want to display the laptop screen, you must unplug the Type C cable connected to the mobile phone.

Due to the N1651 OLED's design, do not connect two laptops or one laptop and a desktop computer at the same time. This can cause power distribution conflicts, resulting in flashing screens or the forced shutdown of the laptop(s).

NOTE:

- If the laptop has a Type C port, please connect via Type C to the N1651 OLED.
- If the laptop only has HDMI ports, please connect via HDMI to the N1651 OLED.
- Do not connect the Type C port of the N1651 OLED portable monitor to two laptops or desktop computers at the same time.

CHAPTER 3: ON SCREEN DISPLAY MENU

3.1 Adjusting the Viewing Angle

Tilt Angle Adjustment

Tilt the monitor backwards to the desired viewing angle via the attached stand (0° to 86°).

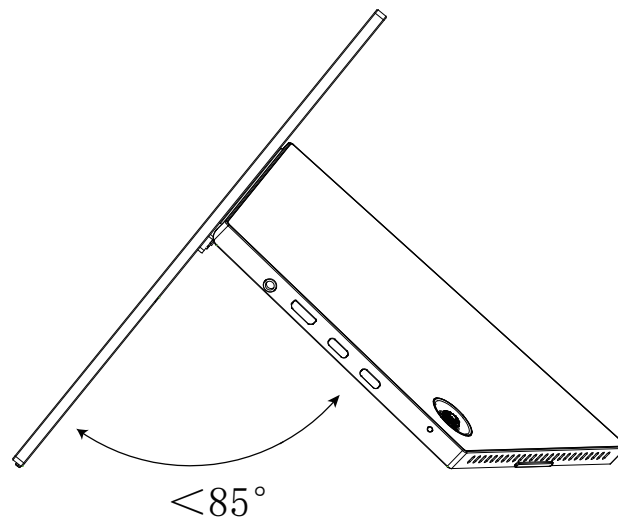

Note:

- ◆ When adjusting, support the monitor firmly with one hand while tilting the stand backwards with the other hand.
- ◆ Always place the device on a flat, stable surface. Failure to do so may cause the device to fall and cause damage to the device and/or personal injury.

ON SCREEN DISPLAY MENU

3.2 Turning the Device On/Off

1. Connect to a power source in one of the available configurations.
2. Press the **Arrow Key** to turn on the monitor.
3. To turn the monitor off, press and hold the **Arrow Key** for 3 seconds.

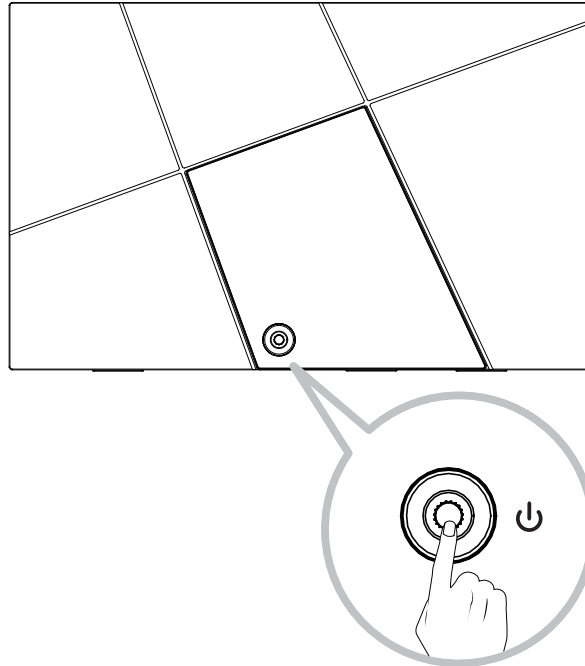

Note:

- ◆ The monitor will still consume some power as long as the power cord is connected to the power outlet. If the monitor is not being used for a long period of time, please disconnect from the power outlet.

Using the Arrow Key

Use the Arrow Key to access the Quick Menu, activate Hot Keys, navigate the On- Screen Display (OSD) Menu, and change the settings.

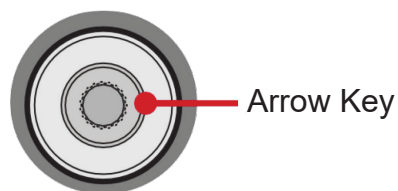

ON SCREEN DISPLAY MENU



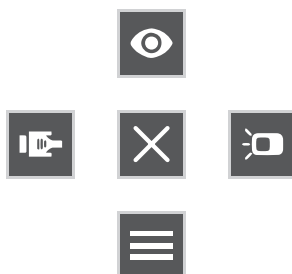

Quick Menu

Move the **Arrow Key** ▲ / ▼ / ◀ / ▶ to activate the Quick Menu.



Note:

- ◆ Follow the key guide that appears on the screen to select the option or make adjustments.

Menu	Description
 Picture Mode	Select one of the preset color settings.
 Contrast/Brightness	Adjust the contrast or brightness level.
 Input Source	Select the input source.
 Main Menu	Enter the On-Screen Display (OSD) Menu.
 Exit	Exit the Quick Menu.

ON SCREEN DISPLAY MENU

Hot Keys

When the On-Screen Display (OSD) Menu is off, you can quickly access special functions by using the **Arrow Key**.

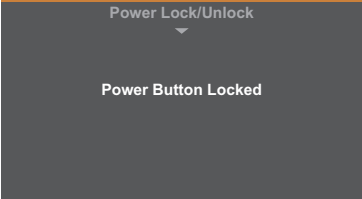
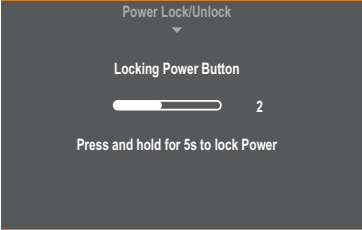
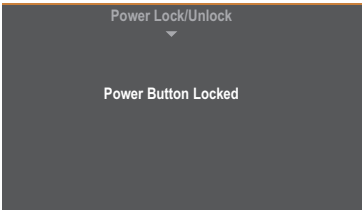
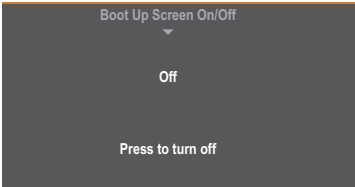
Key	Description
◀	<p>Press and hold the key to lock/unlock the OSD Menu. When the menu appears on the screen, continue holding the key for 5 seconds to lock/unlock the OSD Menu.</p>  <p>If the OSD Menu is locked, the below message will appear on the screen:</p> 
▶	<p>Press and hold the key to lock/unlock the Power button. When the menu appears on the screen, continue holding the key for 5 seconds to lock/unlock the Power button.</p>  <p>If the Power button is locked, the below message will appear on the screen:</p> 
▼	<p>Press and hold the key for 5 seconds to display/hide the AG Neovo boot up screen when the device is turned on.</p> 

ON SCREEN DISPLAY MENU

3.3 Configuring the Settings

Arrow Key Operations

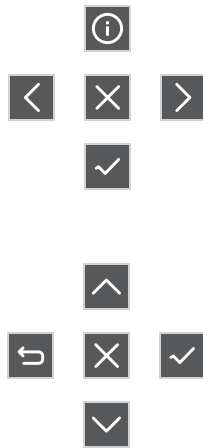

Button	Button
Information	Up
Enter	Down
Return	Left
Exit	Right

1. Move the **Arrow Key** ▲ / ▼ / ◀ / ▶ to display the Quick Menu. Then press the **Key** to display the On-Screen Display (OSD) Menu.

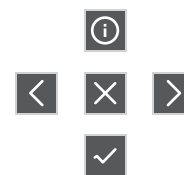
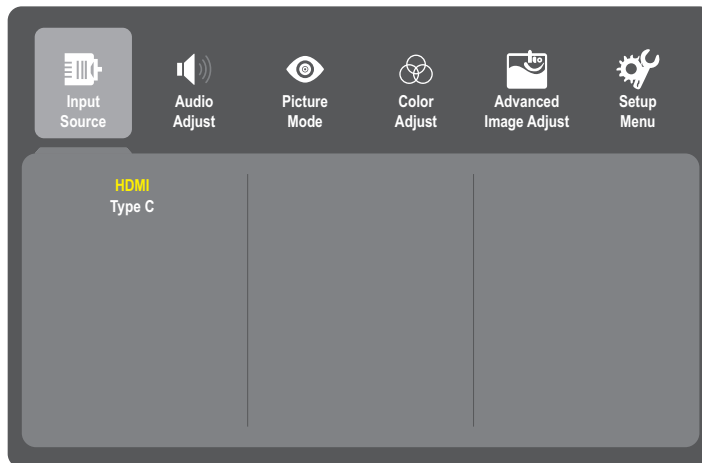

2. Move the **Arrow Key** ◀ or ▶ to select the main menu. Then press the **Key** to enter the selected menu.

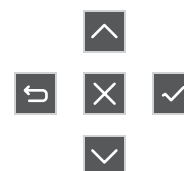
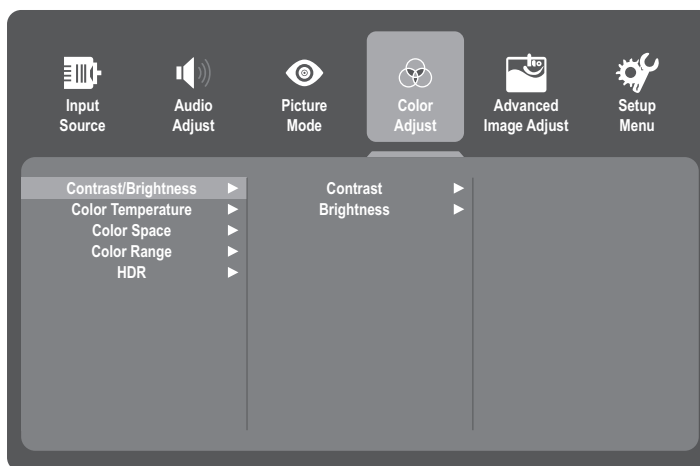

ON SCREEN DISPLAY MENU

3. Move the **Arrow Key** ▲ or ▼ to select the desired menu option. Then press the **✓ Key** to enter the sub-menu.

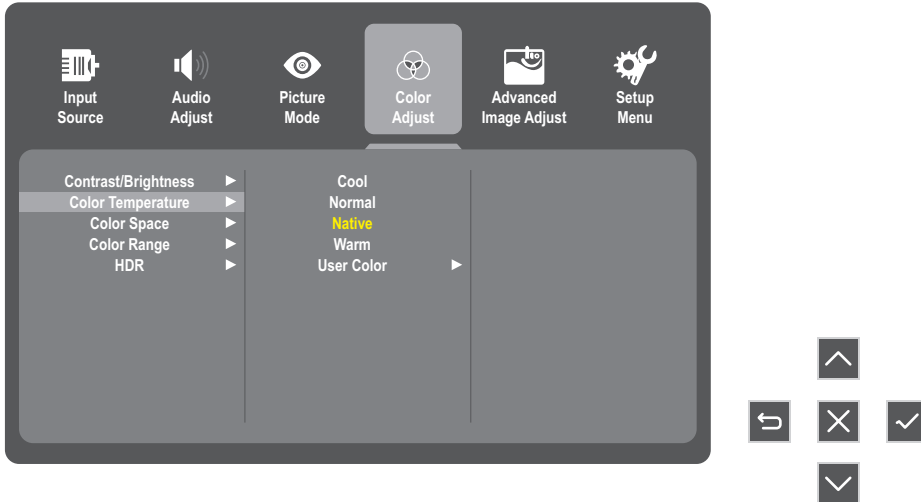

4. Move the **Arrow Key** ▲ or ▼ to adjust/select the setting. Then press the **✓ Key** to confirm. Or move the Arrow Key ◀ or ▶ to make adjustments.

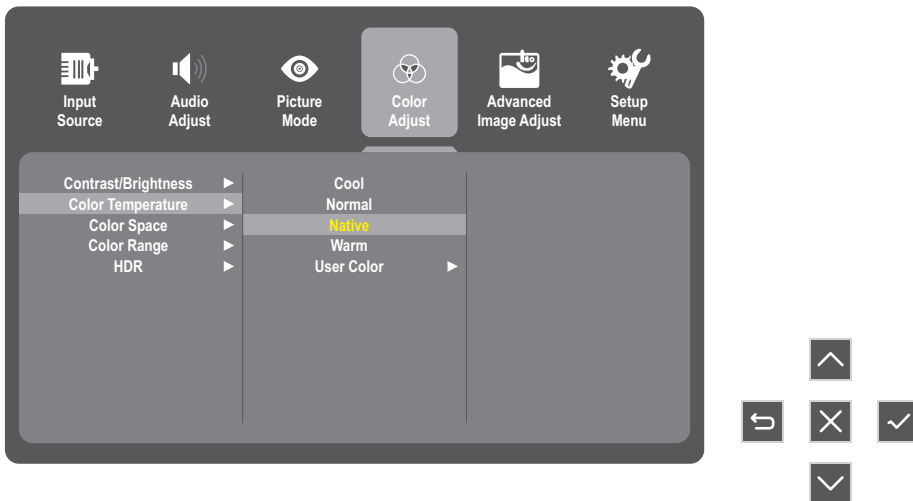

Note:

- ◆ Certain menu option adjustments do not require the user to press the **Arrow Key** to confirm the selection. Follow the key guide to select the option or make adjustments.

5. Follow the **↶ Key** guide to return to the previous screen.

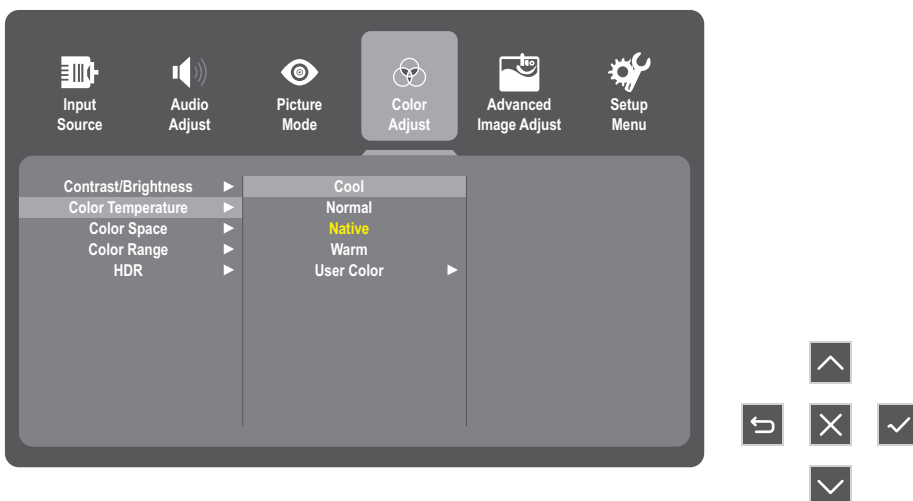

ON SCREEN DISPLAY MENU

Main Menu	Sub-menu	Menu Option		
Input Source	HDMI			
	Type C			
Audio Adjust	Volume	(-/+, 0~100)		
	Mute	On		
		Off		
Picture Mode	Standard			
	FPS Game			
	RTS Game			
	MOBA Game			
	Movie			
	Web			
	Text			
	MAC			
	Mono			
Color Adjust	Contrast/Brightness	Contrast	(-/+, 0~100)	
		Brightness	(-/+, 0~100)	
	Color Temperature	Cool		
		Normal		
		Native		
		Warm		
	User Color	Red	(-/+, 0~100)	
		Green	(-/+, 0~100)	
		Blue	(-/+, 0~100)	
	Color Space	Auto		
		RGB Mode		
		YUV Mode		
	Color Range	Auto		
		Full		
		Limited		
HDR	Auto			
	Off			
Advanced Image Adjust	Sharpness	(-/+,0~100/25)		
	Blue Light Filter	(-/+,0~100/1)		
	Aspect Ratio	4:3		
		Full Screen		
	Overscan	On		
		Off		
Black Level	(-/+, 0~100/10)			

ON SCREEN DISPLAY MENU

Main Menu	Sub-menu	Menu Option
Setup Menu	Language	English
		Français
		Deutsch
		Español
		Italiano
		Suomi
		Русский
		Türkçe
		繁體中文
	Resolution Notice	On
		Off
	Information	Resolution: H. Frequency: V. Frequency: Pixel Clock:
	OSD Timer	5/15/30/60
	OSD Transparency	On
		Off
	LED Indicator	On
		Off
	Standby	On
		Off
	Sleep	30 Minutes
		45 Minutes
		60 Minutes
		120 Minutes
		Off
	ECO Mode	High
		Off
		Low
	DDC/CI	On
		Off
	OSD Reset	

CHAPTER 4: APPENDIX

4.1 Warning Messages

Warning Message	Cause	Solution
No signal	The LCD display cannot detect the input source signal.	<ul style="list-style-type: none">• Check if the input source is turned ON.• Check if the signal cable is properly connected.• Check if any pin inside the cable connector is twisted or broken.
Resolution Notice For best picture quality, change resolution to 1920X1080	The graphics card resolution setting is not the optimal resolution for this model	<ul style="list-style-type: none">• Change the resolution of your graphics card

APPENDIX

4.2 Supported Resolutions

Item	Resolution	Horizontal	Bandwidth	Remark
		Frequency (kHz)	Frequency (Hz)	
1	640×480	31.469	60	DMT
2	640×480	35.000	67	MAC
3	640×480	37.861	72	DMT
4	640×480	37.500	75.0	DMT
5	720×400	31.469	70	DOS
6	800×600	35.156	56	DMT
7	800×600	37.879	60	DMT
8	800×600	48.077	72	DMT
9	800×600	46.875	75	DMT
10	832×624	49.725	75	MAC
11	1024×768	48.363	60	DMT
12	1024×768	56.476	70	DMT
13	1024×768	60.023	75	DMT
14	1152 ×870	68.681	75	MAC
15	1280 ×720	45.000	60	DMT
16	1280 ×960	60.000	60	DMT
17	1280 ×1024	63.981	60	DMT
18	1280 ×1024	79.976	75	DMT
19	1440 ×900	55.935	60	DMT
20	1400 ×1050	65.317	60	DMT
21	1600 ×1200	75.00	60	1.DMT
22	1680 ×1050	65.290	60	DMT
23	1920 ×1080	67.500	60	1.DMT
24	2560 ×1440	88.786	60	
25	3840 ×2160	134.7	60	

4.3 Maintenance

General Precautions

- Make sure the monitor is turned off and the power cable is unplugged from the power outlet.
- Never spray or pour any liquid directly onto the screen or case.
- Handle the monitor with care, as a darker-colored monitor, if scuffed, may show marks more clearly than a lighter-colored monitor.

Cleaning the Screen

- Wipe the screen with a clean, soft, lint-free cloth. This removes dust and other particles.
- If the screen is still not clean, apply a small amount of non-ammonia, non-alcohol based glass cleaner onto a clean, soft, lint-free cloth; then wipe the screen.

Cleaning the Case

- Use a soft, dry cloth.
- If the case is still not clean, apply a small amount of non-ammonia, non-alcohol based, mild non-abrasive detergent onto a clean, soft, lint-free cloth, then wipe the surface.

Disclaimer

- Does not recommend the use of any ammonia or alcohol-based cleaners on the display screen or case. Some chemical cleaners have been reported to damage the screen and/or case of the monitor.
- Will not be liable for damage resulting from use of any ammonia or alcohol-based cleaners.

APPENDIX

4.4 Troubleshooting

This section describes some common problems that you may experience when using the monitor.

Problem or Issue	Possible Solutions
No power	<ul style="list-style-type: none">• Make sure you have turned on the monitor by pressing the Arrow Key.• Make sure the power cord is properly and securely connected to the monitor and power outlet.• Plug another electrical device into the power outlet to verify that the outlet is supplying power.
Power is On, but no image appears on screen	<ul style="list-style-type: none">• Make sure the video cable connecting the monitor to the computer is properly and securely connected.• Adjust the brightness and contrast settings.• Make sure the correct input source is selected.
Wrong or abnormal colors	<ul style="list-style-type: none">• If any colors (red, green, or blue) are missing, check the video cable to make sure it is properly and securely connected. Loose or broken pins in the cable connector could cause an improper connection.• Connect the monitor to another computer.• If you have an older graphics card, contact ViewSonic® for a non-DDC adapter.
Screen image is too light or dark	<ul style="list-style-type: none">• Adjust brightness and contrast settings via the OSD Menu.• Reset the monitor to factory settings.
Screen image cuts in and out	<ul style="list-style-type: none">• Make sure the correct input source is selected.• Check for bent or broken pins in the video cable connector.• Make sure the video cable connecting the monitor to the computer is properly and securely connected.
Screen image is blurred	<ul style="list-style-type: none">• Adjust the resolution to the correct Aspect Ratio.• Reset the monitor to factory settings.
The screen isn't centered correctly	<ul style="list-style-type: none">• Adjust the horizontal and vertical controls via the OSD Menu.• Check the Aspect Ratio.• Reset the monitor to factory settings.
The screen appears yellow	<ul style="list-style-type: none">• Make sure the "Blue Light Filter" is Off.
The OSD Menu does not appear on the screen/the OSD controls are inaccessible	<ul style="list-style-type: none">• Check whether the OSD Menu is locked.• Turn off the monitor, unplug the power cord, plug it back in, and then turn on the monitor.• Reset the monitor to factory settings.
Control panel keys do not work	<ul style="list-style-type: none">• Press only one key at a time.• Restart the computer.
No audio output	<ul style="list-style-type: none">• If using earbuds/headphones, be sure to connect the 3.5mm headphone jack.• Make sure the volume is unmuted or not set to 0.• Check the Audio Input setting.
The monitor will not adjust	<ul style="list-style-type: none">• Make sure there are no obstructions near or on the monitor, and that there is adequate spacing.• For more information, see "Adjusting the Viewing Angle".

APPENDIX

USB devices connected to the monitor do not work	<ul style="list-style-type: none">• Make sure the USB cable is connected properly.• Try changing to another USB port (if applicable).• Some USB devices require a higher electric current; connect the device directly to the computer.
The external device is connected, but no image appears on the screen	<ul style="list-style-type: none">• Make sure the Power is On• Adjust brightness and contrast via the OSD Menu.• Check the connecting cable and make sure it is properly and securely connected. Loose or broken pins in the cable connector could cause an improper connection.

CHAPTER 5: SPECIFICATIONS

5.1 Monitor Specifications

N1651		
Panel	Panel Type	OLED
	Panel Size	15.6"
	Max. Resolution	UHD 3840 x 2160
	Pixel Pitch	0.896 mm
	Brightness	400 cd/m ²
	Contrast Ratio	100000:1
	Viewing Angle (H/V)	170°/170°
	Display Colour	1.07B
	Response Time	1 ms
	Surface Treatment	Glare, 3H Hard Coating
Frequency (H/V)	H Freq.	15 kHz ~ 160 kHz
	V Freq.	40 Hz ~ 75 Hz
Input	Mini HDMI	1.4 x 1
	Type-C	DP 1.2 x1
Audio	Audio Out	Stereo Audio Jack (3.5 mm)
	Internal Speakers	1W x 2
	Speaker Output(RMS)	0.8W x 2
Power	Power Supply	External
	Power Requirements	5-20V, 3A
	On Mode	11.2W (On)
	Stand-by Mode	< 0.5W
	Off Mode	< 0.3W
Glass	Thickness	0.55 mm
	Reflection Rate	< 1%
	Transmission Rate	≥88%
	IK Rating	IK03
	Haze	< 2%
Operating Conditions	Temperature	0°C-40°C (32°F-104°F)
	Humidity	20%-80% (non-condensing)
Storage Conditions	Temperature	-20°C-60°C (-4°F-140°F)
	Humidity	5%-90% (non-condensing)
Dimensions	Product with Base (W x H x D)	351.9 x 223.0 x 15.1 mm (13.9" x 8.8" x 0.6")
	Packaging (W x H x D)	441.0 x 320.0 x 93.0 mm (17.4" x 12.6" x 3.7")
Weight	Product with Base	0.7 kg (1.5 lb)
	Product	2.1 kg (4.6 lb)

Note:

- ◆ All specifications are subject to change without prior notice.

SPECIFICATIONS

5.2 Monitor Dimensions

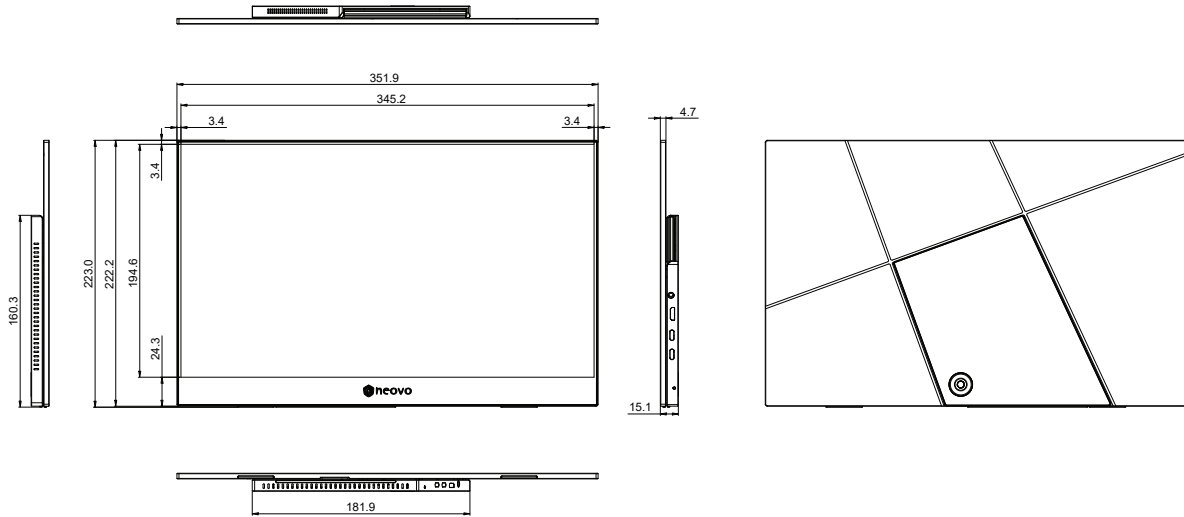

AG Neovo

Company Address: 5F-1, No. 3-1, Park Street, Nangang District, Taipei, 11503, Taiwan.

Copyright © 2024 AG Neovo. All rights reserved.

N16510_UM_V010