



THE DISPLAY CHOICE  
OF PROFESSIONALS™

[www.agneovo.com](http://www.agneovo.com)

DR-2202 LCD Monitor  
**User Manual**

# TABLE OF CONTENTS

<b>SAFETY INFORMATION</b> .....	<b>3</b>
WEEE.....	3
EMC Information .....	4
<b>PRECAUTIONS</b> .....	<b>8</b>
Cautions When Setting Up .....	8
Cautions When Using.....	10
Cleaning and Maintenance.....	10
Notice for the LCD Monitor .....	11
Notice for the LCD Monitor .....	12
<b>CHAPTER 1: PRODUCT DESCRIPTION</b> .....	<b>13</b>
1.1 Package Contents .....	13
1.2 Wall Mounting Installation.....	14
1.3 Using the Monitor .....	15
1.3.1 Front View .....	15
1.3.2 Rear View and Keypad Buttons .....	15
1.3.3 Input/Output Terminals .....	17
1.4 Cable Cover Removal .....	18
1.5 Making Connections.....	19
<b>CHAPTER 2: ON SCREEN DISPLAY MENU</b> .....	<b>20</b>
2.1 Using the OSD Menu .....	20
2.2 OSD Menu Tree .....	22
<b>CHAPTER 3: ADJUSTING THE SETTINGS</b> .....	<b>23</b>
3.1 Picture Menu .....	23
3.2 Audio Menu .....	25
3.3 VGA Menu .....	26
3.4 Setting Menu .....	27
3.5 Information Menu .....	28
<b>CHAPTER 4: APPENDIX</b> .....	<b>29</b>
4.1 Warning Message.....	29
4.2 Supported Resolutions .....	30
4.3 Cleaning .....	31
4.4 Troubleshooting.....	32
<b>CHAPTER 5: SPECIFICATIONS</b> .....	<b>33</b>
5.1 Monitor Specifications .....	33
5.2 Monitor Dimensions.....	34

# SAFETY INFORMATION

## WEEE

Disposal of Waste Equipment by Users in Private Household in the European Union.



This symbol on the product or on its packaging indicates that this product must not be disposed of with your other household waste. Instead, it is your responsibility to dispose of your waste equipment by handing it over to a designated collection point for the recycling of waste electrical and electronic equipment. The separate collection and recycling of your waste equipment at the time of disposal will help to conserve natural resources and ensure that it is recycled in a manner that protects human health and the environment. For more information about where you can drop off your waste equipment for recycling, please contact your local city office, your household waste disposal service or the shop where you purchased the product

For Private Households in the European Union. To help conserve natural resources and ensure the product is recycled in a manner that protects human health and the environment, we would like to bring your attention to the following:

- The crossed-out dustbin on the device or outer packaging indicates the product is compliant with European WEEE (Waste Electrical and Electronic Equipment) Directive
- Always dispose of the old devices separately from household waste
- Batteries should be removed beforehand and disposed separately to the right collection system
- You are responsible with regard to the deletion of personal data on old devices before disposal
- Private households can hand in their old devices free of charge
- For more information about where you can drop off your waste equipment for recycling, please contact your local city office, your household waste disposal service or the shop where you purchased the product

# SAFETY INFORMATION

## EMC Information

Essential performance of DR-2202 White is to display images and operate functions normally

### CAUTION

The DR-2202 requires special precautions regarding EMC and need to be installed put into service and used according to the following information.

Do not use any cables other than the cables that provided or specified by us. Using other cables may cause the increase of emission or decrease of immunity.

Do not put any portable and mobile RF communications equipment close to the DR-2202. Doing so may affect the DR-2202.

The DR-2202 should not be used adjacent to or stacked with other equipment. If adjacent or stacked use is necessary the equipment or system should be observed to verify normal operation in the configuration in which it will be used.

Anyone who connects additional equipment to the signal input part or signal output parts configuring a medical system, responsible that the system complies with the requirements of IEC/ EN60601-1-2.

<b>Guidance and manufacturer's declaration – electromagnetic emissions</b>		
The DR-2202 is intended for use in the electromagnetic environment specified below. The customer or the user of the DR-2202 White should assure that it is used in such an environment. Not Lifesupporting Medical Equipment.		
<b>Emissions test</b>	<b>Compliance</b>	<b>Electromagnetic environment – guidance</b>
RF emissions CISPR11/EN55011	Group 1	The DR-2202 uses RF energy only for its internal function. Therefore, its RF emission are very low and are not likely to cause any interference in nearby electronic equipment.
RF emissions CISPR11/EN55011	Class B	The DR-2202 is suitable for use in all establishments, including domestic establishments and those directly connected to the public lowvoltage power supply network that supplies buildings used for domestic purposes.
Harmonic emissions IEC/EN61000-3-2	Class A	
Voltage fluctuations /flicker emissions IEC/ EN61000-3-3	Class A	

<b>Standard</b>	<b>Test item</b>	<b>Standard</b>
EN60601-1-2:2007	RAD & CON	EN55011(EMI)
	Harmonic	EN61000-3-2
	Flicker	EN61000-3-3
	ESD	IEC 61000-4-2: 2008
	RS	IEC 61000-4-3: 2006+A1:2007+A2:2010
	EFT	IEC 61000-4-4: 2012
	Surge	IEC 61000-4-5: 2005
	CS	IEC 61000-4-6: 2008
	PFM	IEC 61000-4-8: 2009
	DIP	IEC 61000-4-11: 2004

# SAFETY INFORMATION

<b>Guidance and manufacturer's declaration – electromagnetic immunity</b>			
The DR-2202 is intended for use in the electromagnetic environment specified below. The customer or the user of The DR-2202 should assure that it is used in such an environment. Not Life-supporting Medical Equipment.			
<b>Immunity test</b>	<b>IEC/EN60601 test level</b>	<b>Compliance level</b>	<b>Electromagnetic environment – guidance</b>
Electrostatic discharge (ESD) IEC/EN61000- 4-2	±6kV contact ±8kV air	±6kV contact ±8kV air	Floors should be wood, concrete or ceramic tile. If floors are covered with synthetic material, the relative humidity should be at least 30%.
Electrical fast transient/ burst IEC/EN61000- 4-4	±2kV for power supply lines ±1kV for input/output lines	±2kV for power supply lines ±1kV for input/output lines	Mains power quality should be that of a typical commercial or hospital environment.
Surge IEC/EN61000- 4-5	±1kV line(s) to line(s) ±2kV line(s) to earth	±1kV line(s) to line(s) ±2kV line(s) to earth	Mains power quality should be that of a typical commercial or hospital environment.
Voltage dips, short interruptions and voltage variations on power supply input lines IEC/ EN61000- 4-1	<5% UT (>95% dip in UT) for 0.5 cycle 40% UT (60% dip in UT) for 5 cycles 70% UT (30% dip in UT) for 25 cycles <5% UT (>95% dip in UT) for 5sec	<5% UT (>95% dip in UT) for 0.5 cycle 40% UT (60% dip in UT) for 5 cycles 70% UT (30% dip in UT) for 25 cycles <5% UT (>95% dip in UT) for 5sec	Mains power quality should be that of a typical commercial or hospital environment. If the user of the DR-2202 requires continued operation during power mains interruptions, it is recommended that the DR-2202 be powered from an uninterruptible power supply or a battery.
Power frequency (50/60Hz) magnetic field IEC/EN61000-4-8	3.0 A/m	3.0 A/m	Power frequency magnetic fields should be at levels characteristic of a typical location in a typical commercial or hospital environment.
<b>NOTE:</b> UT is the A.C. mains voltage prior to application of the test level.			

Mains power quality should be that of a typical commercial or hospital environment. If the user of the DR-2202 requires continued operation during power mains interruptions, it is recommended that the DR-2202 be powered from an uninterruptible power supply or a battery.

# SAFETY INFORMATION

## Guidance and manufacturer's declaration – electromagnetic immunity

The DR-2202 is intended for use in the electromagnetic environment specified below. The customer or the user of the DR-2202 should assure that it is used in such an environment. Not Lifesupporting Medical Equipment.

Immunity test	IEC/EN60601 test level	Compliance level	Electromagnetic environment – guidance
<p>Conducted RF IEC/ EN61000 4-6</p> <p>Radiated RF IEC/ EN61000 4-3</p>	<p>3Vrms 150kHz to 80MHz</p> <p>3Vrms 80MHz to 2.5GHz</p>	<p>3Vrms 150kHz to 80MHz</p> <p>3Vrms 80MHz to 2.5GHz</p>	<p>Portable and mobile RF communications equipment should be used no closer to any part of the DR-2202, including cables, than the recommended separation distance calculated from the equation applicable to the frequency of the transmitter.</p> <p>Recommended Separation distance</p> <p>0.15MHz to 80 MHz</p> $d = \left[ \frac{3,5}{V_1} \right] \sqrt{P}$ <p>80MHz to 800MHz</p> $d = \left[ \frac{3,5}{E_1} \right] \sqrt{P}$ <p>800MHz to 2.5GHz</p> $d = \left[ \frac{7}{E_1} \right] \sqrt{P}$ <p>Where "P" is the maximum output power rating of the transmitter in watts (W) according to the transmitter manufacturer and "d" is the recommended separation distance in meters (m). Field strengths from fixed RF transmitters, as determined by an electromagnetic site survey (a), should be less than the compliance level in each frequency range (b). Interference may occur in the vicinity of equipment marked with the following symbol.</p> 

**NOTE 1** At 80 MHz and 800 MHz, the higher frequency range applies.

**NOTE 2** These guidelines may not apply in all situations. Electromagnetic propagation is affected by absorption and reflection from structures, objects and people.

(a) Field strengths from fixed transmitters, such as base stations for radio (cellular/cordless) telephones and land mobile radios, amateur radio, AM and FM radio broadcast and TV broadcast cannot be predicted theoretically with accuracy. To assess the electromagnetic environment due to fixed RF transmitters, an electro-magnetic site survey should be considered. If the measured field strength in the location in which the DR-2202 is used exceeds the applicable RF compliance level above, the DR-2202 should be observed to verify normal operation. If abnormal performance is observed, additional measures may be necessary, such as reorienting or relocating the DR-2202.

(b) Over the frequency range 150kHz to 80MHz, field strengths should be less than [V1] V/m.

# SAFETY INFORMATION

## Recommended separation distances between portable and mobile RF communications equipment and the DR-2202

The DR-2202 is intended for use in an electromagnetic environment in which radiated RF disturbances are controlled. The customer or the user of the DR-2202 can help prevent electromagnetic interference by maintaining a minimum distance between portable and mobile RF communications equipment (transmitters) and the DR-2202 as recommended below, according to the maximum output power of the communications equipment.

Rated maximum output power of transmitter W	Separation distance according to frequency of transmitter m		
	150kHz to 80MHz $d=1.2 \sqrt{P}$	80MHz to 800MHz $d=1.2 \sqrt{P}$	800MHz to 2.5GHz $d=2.3 \sqrt{P}$
0.01	0.12	0.12	0.23
0.1	0.38	0.38	0.73
1	1.2	1.2	2.3
10	3.8	3.8	7.3
100	12	12	2.3

For transmitters rated at a maximum output power not listed above, the recommended separation distance "d" in meters (m) can be estimated using the equation applicable to the frequency of the transmitter, where "P" is the maximum output power rating of the transmitter in watts (W) according to the transmitter manufacturer.

NOTE 1 At 80 MHz and 800 MHz, the separation distance for the higher frequency range applies.

NOTE 2 These guidelines may not apply in all situations. Electromagnetic propagation is affected by absorption and reflection from structures, objects and people.

### Cable length

Power Cord : Accessary	1.8m
------------------------	------

### Ventilation Requirements for Enclosure Locating







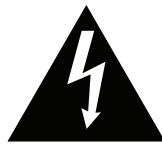

To allow heat to disperse, avoid installing the LCD monitor directly on the cabinet wall and make sure the operating/storage temperature/humidity requirements are met as described below:

- Operating conditions: 0°C-40°C (32°F-104°F)
- Operating humidity (non-condensing): 20%-80%
- Operating altitude: < 10,000 feet (3,048m)
- Storage conditions: -20°C-60°C (-4°F-140°F)
- Storage humidity (non-condensing): 10%-90%
- Storage altitude : 500hPa~1,060hPa
- Transport conditions: -20°C-60°C (-4°F-140°F)
- Transport humidity (non-condensing): 10%-90%
- Transport altitude: 500hPa~1,060hPa

# RECAUTIONS



## Symbols used in this manual

	This icon indicates the existence of a potential hazard that could result in personal injury or damage to the product.		ISO 7010-M002: Follow instructions for use
	This icon indicates important operating and servicing information.		This icon indicates complies with the 93/42/EEC, EN60601-1, EN 60601-1-2 of related European standards.
	IEC 60417 -5009 : STAND- BY		IEC 60417 -5031 : Direct Current
	IEC 60417 -5032: Alternating Current		IEC 60417 -5021: Equipotentiality

## Notice

- Read this User Manual carefully before using the LCD monitor and keep it for future reference.
- The product specifications and other information provided in this User Manual are for reference only. All information is subject to change without notice. Updated content can be downloaded from our web site at <http://www.agneovo.com>.
- To register online, go to <http://www.agneovo.com>.
- To protect your rights as a consumer, do not remove any stickers from the LCD monitor. Doing so may affect the determination of the warranty period.



# RECAUTIONS

---

## Cautions When Setting Up

---



Do not place the LCD monitor near heat sources, such as a heater, exhaust vent, or in direct sunlight.

---



Do not cover or block the ventilation holes in the housing.

---



Place the LCD monitor on a stable area. Do not place the LCD monitor where it may subject to vibration or shock.

---



Place the LCD monitor in a well-ventilated area.

---



Do not place the LCD monitor outdoors.

---



Do not place the LCD monitor in a dusty or humid environment.

---



Do not spill liquid or insert sharp objects into the LCD monitor through the ventilation holes. Doing so may cause accidental fire, electric shock or damage the LCD monitor.

---

# RECAUTIONS

## Cautions When Using



Use only the power cord supplied with the LCD monitor.



The power outlet should be installed near the LCD monitor and be easily accessible.



If an extension cord is used with the LCD monitor, ensure that the total current consumption plugged into the power outlet does not exceed the ampere rating.



Do not allow anything to rest on the power cord. Do not place the LCD monitor where the power cord may be stepped on.



If the LCD monitor will not be used for an indefinite period of time, unplug the power cord from the power outlet.



To disconnect the power cord, grasp and pull by the plug head. Do not tug on the cord; doing so may cause fire or electric shock.

The mains plug or appliance coupler is used as the disconnect device, the disconnect device shall remain readily operable. Always completely disconnect the power cord set from your product whenever you are working or cleaning on it. Do not make connections while the power is on, because a sudden rush of power can damage sensitive electronic components.



Do not unplug or touch the power cord with wet hands.

## Cleaning and Maintenance

Disconnect this equipment from any AC outlet before cleaning. Do not use liquid or spray detergents for cleaning. Use a damp cloth. Keeping to clean your monitor by monthly.



The LCD monitor comes with NeoV™ Optical Glass. Use a soft cloth to clean the glass surface and the housing. The monitor can be cleaned using a cloth moistened with 95% ethyl alcohol.



Do not rub or tap the surface of the glass with sharp or abrasive items such as a pen or screwdriver. This may result in scratching the surface of the glass.



Do not attempt to service the LCD monitor yourself, refer to qualified service personnel. Opening or removing the covers may expose you to dangerous voltage or other risks.



### Warning:



Unplug the power cord from the power outlet and refer to qualified service

personnel under the following conditions:

- ◆ When the power cord is damaged.
- ◆ If the LCD monitor has been dropped or the housing has been damaged.
- ◆ If the LCD monitor emits smoke or a distinct odor.



### Warning:



Ceiling mount or mount on any other horizontal surface overhead are not advisable.

Installation in contravention of the instructions may result in undesirable consequences, particularly hurting people and damaging property. Users who have already mounted the display on the ceiling or any other horizontal surface overhead are strongly advised to contact AG Neovo for consultations and solutions to help ensure a most pleasurable and fulfilling display experience.

# RECAUTIONS

---

## Notice for the LCD Monitor

---

In order to maintain the stable luminous performance, it is recommended to use low brightness setting.

Due to the lifespan of the lamp, it is normal that the brightness quality of the LCD monitor may decrease with time.

When static images are displayed for long periods of time, the image may cause an imprint on the LCD monitor. This is called image retention or burn-in.

To prevent image retention, do any of the following:

- Set the LCD monitor to turn off after a few minutes of being idle.
- Use a screen saver that has moving graphics or a blank white image.
- Switch desktop backgrounds regularly.
- Adjust the LCD monitor to low brightness settings.
- Turn off the LCD monitor when the system is not in use.

Things to do when the LCD monitor shows image retention:

- Turn off the LCD monitor for extended periods of time. It can be several hours or several days.
- Use a screen saver and run it for extended periods of time.
- Use a black and white image and run it for extended periods of time.

---

When the LCD monitor is moved from one room to another or there is a sudden change from low to high ambient temperature, dew condensation may form on or inside the glass surface. When this happens, do not turn on the LCD monitor until the dew disappears.

Due to humid weather conditions, it is normal for mist to form inside the glass surface of the LCD monitor. The mist will disappear after a few days or as soon as the weather stabilizes.

---

There are millions of micro transistors inside the LCD monitor. It is normal for a few transistors to be damaged and to produce spots. This is acceptable and is not considered a failure.

The intended use of the DR-2202 is to serve as a LCD monitor for integration with the hospital system. It is designed for general purpose for adults using at hospital environment continuous operation.

For displaying and viewing of images for reference. The use of this device does not require any direct contact with patients.

---

Accessory equipment connected to the analog and digital interfaces must be in compliance with the respective nationally harmonized IEC standards (i.e. IEC 60950 for data processing equipment, IEC 60065 for video equipment, IEC 61010-1 for laboratory equipment, and IEC 60601-1 for medical equipment.) Furthermore all configurations shall comply with the system standard IEC 60601-1-1. Everybody who connects additional equipment to the signal input part or signal output part configures a medical system, and is therefore, responsible that the system complies with the requirements of the system standard IEC 60601-1-1. The unit is for exclusive interconnection with IEC 60601-1 certified equipment in the patient environment and IEC 60XXX certified equipment outside of the patient environment. If in doubt, consult the technical services department or your local representative.

---

Grounding reliability can only be achieved when the equipment is connected to an equivalent receptacle marked "Hospital Only" or "Hospital Grade".

---

# RECAUTIONS

---

## Notice for the LCD Monitor

---

Use a power cord that matches the voltage of the power outlet, which has been approved and complies with the safety standard of your particular country.

---

The single device output analog signals through ADC element (Analog Digital Convert) conversion to become a digital signal and the video signal is via Video Decoder conversion. It has become the same digital signal, these signals via Scaler IC as zoom in or out action and digital image processing, then through the cable line transmission LVDS signals to one of the LCD module. The last by the clock controller (Timing Controller, TCON), the clock signal is transmitted to the drive IC on the panel and turn on Backlight for LCD module light source by Scaler control..

---

**WARNING:** No protection against the ingress of water : IPX0

---

**WARNING** – Do not modify this equipment without authorization of the manufacturer.

Installation and OSD adjusting should only be carried by manufacturer trained and authorized personnel.

---

**WARNING** – To avoid risk of electric shock, this equipment must only be connected to a supply mains with protective earth.

---

**WARNING** – Equipotential terminal: The terminal shall not be used for a PROTECTIVE EARTH CONNECTION.

---

**WARNING** – If there is any other problem, please consult or return the device to your distributor. Do not try to repair a defective device.

---

**WARNING** – Please do not touch patient and this medical device at the same time.

---

**WARNING** – Users must not allow SIP/SOPs and the patient to come into contact at the same time.

---

**CAUTION:** This adapter Manufacturer/model is a forming part of the medical device.

---

◆ Power by class I power supply.

◆ Adapter manufacturer/model:

ADAPTER TECH: ATM065T-P120

Input/output: 100-240V~50-60Hz, 12V(  )5A

Provides isolation: MOPP

Mode of operation: Continuous operation

---

**WARNING:** Use suitable mounting apparatus to avoid risk of injury.

---

**WARNING:** The equipment not suitable for use in the presence of a flammable anesthetic mixture with air or with oxygen or nitrous: Not AP or APG Category

---

**CAUTION:** No applied part.

Make sure the user not to contact medical device and the patient at the same time.

---

**CAUTION:** Transport should only be undertaken in a flat surface.

---

# CHAPTER 1: PRODUCT DESCRIPTION

## 1.1 Package Contents

When unpacking, check if the following items are included in the package. If any of them is missing or damaged, contact your dealer.

LCD monitor

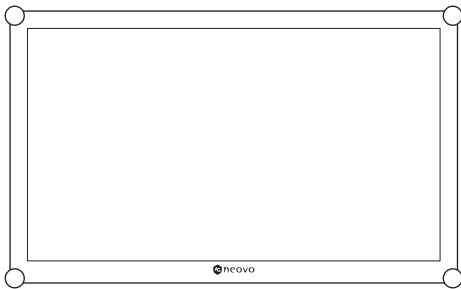

Quick Start Guide



Power adapter

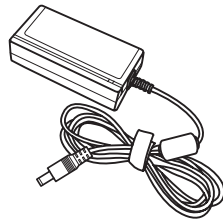

Power cord

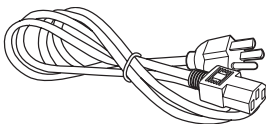

HDMI cable

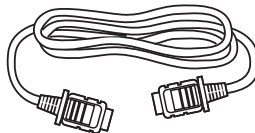

### Note:

Must use only the supplied power adapter:

- ◆ ADAPTER TECH  
Model no.: ATM065T-P120  
Rating: 12V/5A 60W

### Note:

- ◆ The pictures are for reference only. Actual items may vary upon shipment.

# PRODUCT DESCRIPTION

## 1.2 Wall Mounting Installation

To wall mount the LCD monitor, do the following steps:

- 1 Place the LCD monitor with the screen side down on a cushioned surface.
- 2 Screw the mounting bracket to the VESA holes at the rear of the LCD monitor.

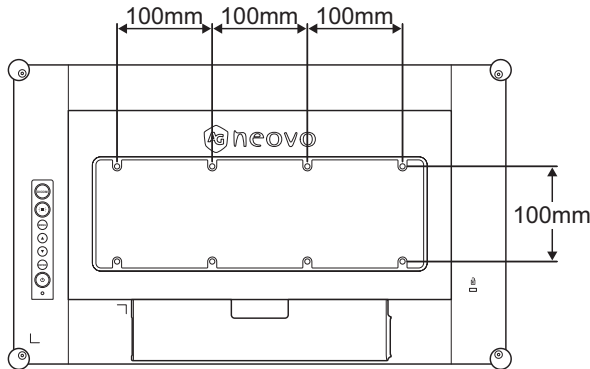

### Note:

To protect the glass panel, place a towel or soft cloth before laying the LCD monitor down.



### Warning:



Ceiling mount or mount on any other horizontal surface overhead are not advisable.

Installation in contravention of the instructions may result in undesirable consequences, particularly hurting people and damaging property. Users who have already mounted the display on the ceiling or any other horizontal surface overhead are strongly advised to contact AG Neovo for consultations and solutions to help ensure a most pleasurable and fulfilling display experience.

### Note:

Take measures to prevent the LCD monitor from falling down and lessen possible injury and damage to the display in case of earthquakes or other disasters.

- ◆ Use only the 100 x 100 mm and 300 x 100 mm wall mount kit recommended by AG Neovo.
- ◆ Secure the LCD monitor on a solid wall strong enough to bear its weight.

# PRODUCT DESCRIPTION

## 1.3 Using the Monitor

### 1.3.1 Front View

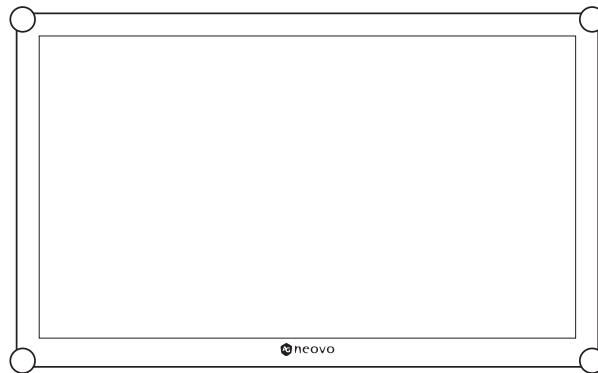

### 1.3.2 Rear View and Keypad Buttons

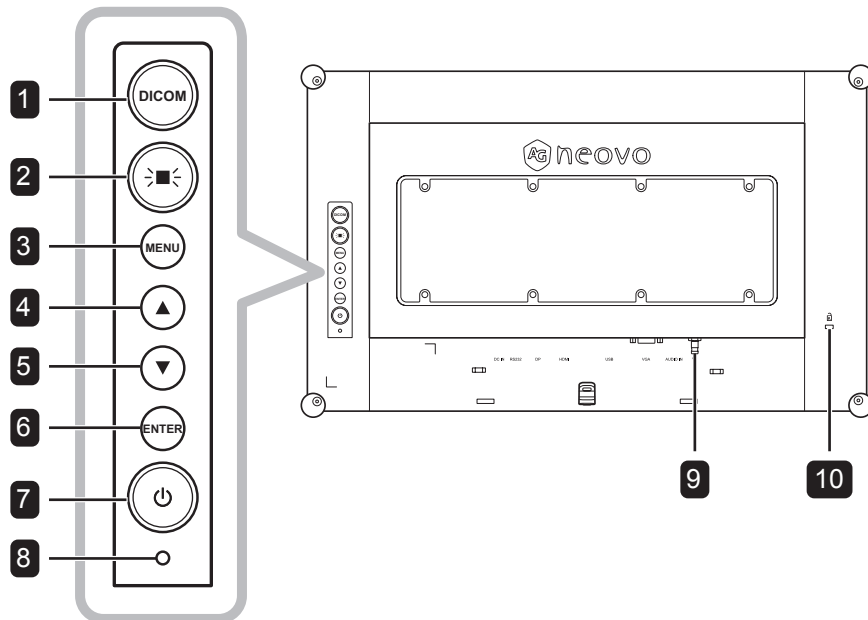

# PRODUCT DESCRIPTION

## 1 DICOM

- Press to toggle the DICOM function on or off. This function is used for reliably uniform grayscale and brightness, crucial for accurate medical assessments. If enabled, the system is automatically set the **PICTURE MODE** setting to **DICOM**.



- When OSD menu is ON, press to close the OSD menu.

## 2 LIGHT BOX ( )

- Press to toggle the LIGHT BOX function on or off. This function is used for traditional X-ray films. If enabled, the screen background is automatically turned white.



- When OSD menu is ON, press to close the OSD menu.

## 3 MENU

Press to display/hide the OSD menu.

## 4 UP (▲)

**Hot Key: Audio Volume Adjustment**

- Press to display the volume bar.



Then press the ▲/▼ button to adjust the volume level.

- When OSD menu is ON, press to select an option or adjust the settings.

## 5 DOWN (▼)

**Hot Key: Audio Volume Adjustment**

- Press to display the volume bar.



Then press the ▲/▼ button to adjust the volume level.

- When OSD menu is ON, press to select an option or adjust the settings.

## 6 ENTER

**Hot Key: Input Source Selection**

- Press to display the Input Source menu.

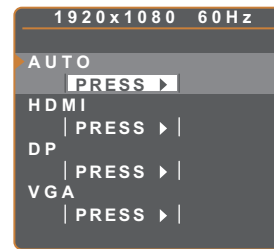

Then press the ▲/▼ button to select the desired input source, and then press the **ENTER** button.

- When OSD menu is ON, press to enter the submenu or confirm the setting.

## 7 POWER (⏻)

Press to turn the power on or off.

## 8 POWER LED Indicator

- Indicate the operating status of the LCD monitor:
  - Lights Green when the LCD monitor is turned on.
  - Lights Amber when the LCD monitor is in standby mode.
  - Lights Off when the LCD monitor is turned off.

## 9 GROUNDING STUD

Connect to a proper earth ground.

## 10 KENSINGTON LOCK

Used for security and theft prevention.



# PRODUCT DESCRIPTION

## 1.3.3 Input/Output Terminals

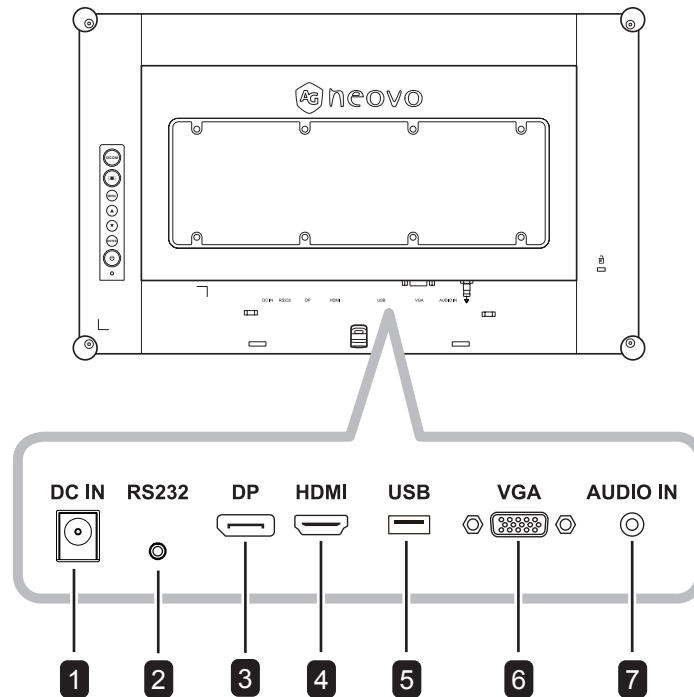

- 1 DC IN**  
Connect with the supplied power adaptor.
- 2 RS232**  
Connect RS232 input from external equipment.
- 3 DP**  
Connect DisplayPort signals input.
- 4 HDMI**  
Connect HDMI signals input.
- 5 USB (SERVICE)**  
Connect USB 2.0 for service.
- 6 VGA**  
Connect VGA signals input.
- 7 AUDIO IN**  
Connect audio signals input (3.5 mm Stereo Audio Jack).

# PRODUCT DESCRIPTION

## 1.4 Cable Cover Removal

To remove the cable cover, do the following steps:

- 1 Place the LCD monitor with the screen side down on a cushioned surface. Then remove the screw securing the cable cover.
- 2 Push the latches to disengage the cable cover from its compartment on the rear of the LCD monitor.
- 3 Remove the cable cover.

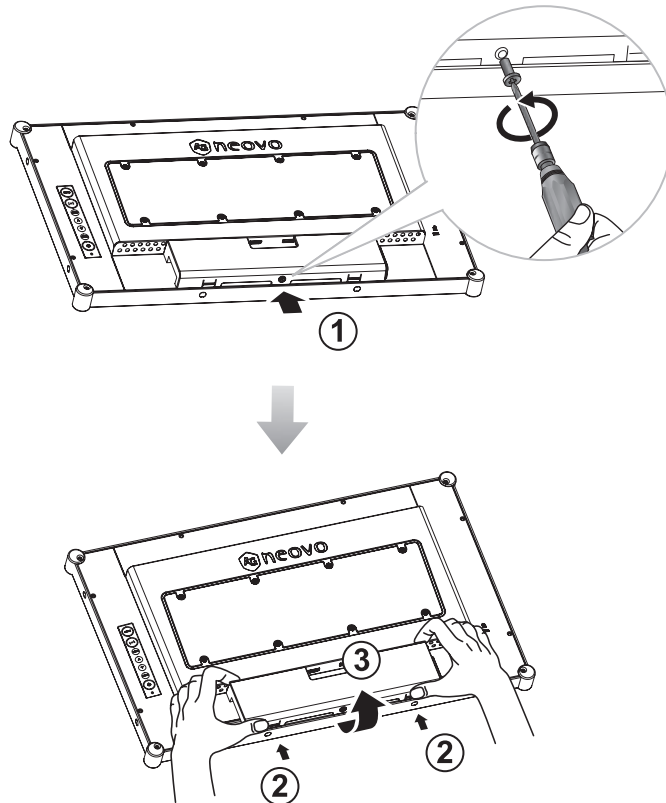

### Note:

- ◆ To replace the cable cover, do the following:  
By pressing both latches, align and install the cable cover to its compartment. Then secure the cover with the screw.

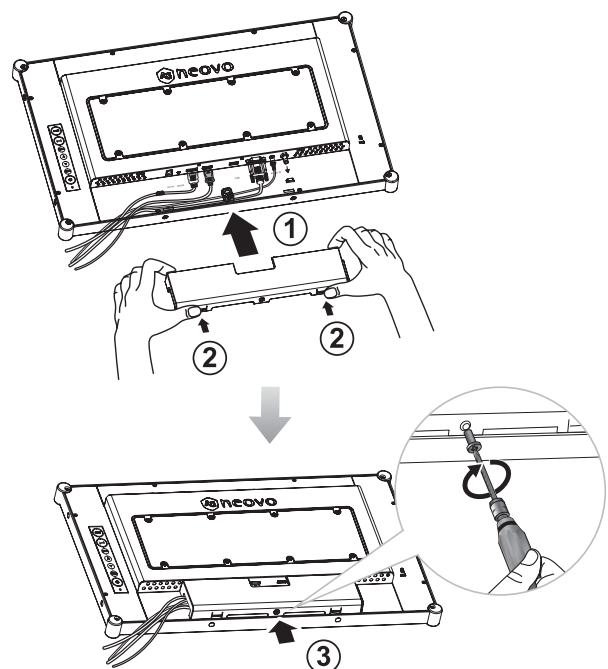

# PRODUCT DESCRIPTION

## 1.5 Making Connections

Before connecting any cables, remove the cable cover to access the I/O terminals on the rear of the LCD monitor. See page 18.

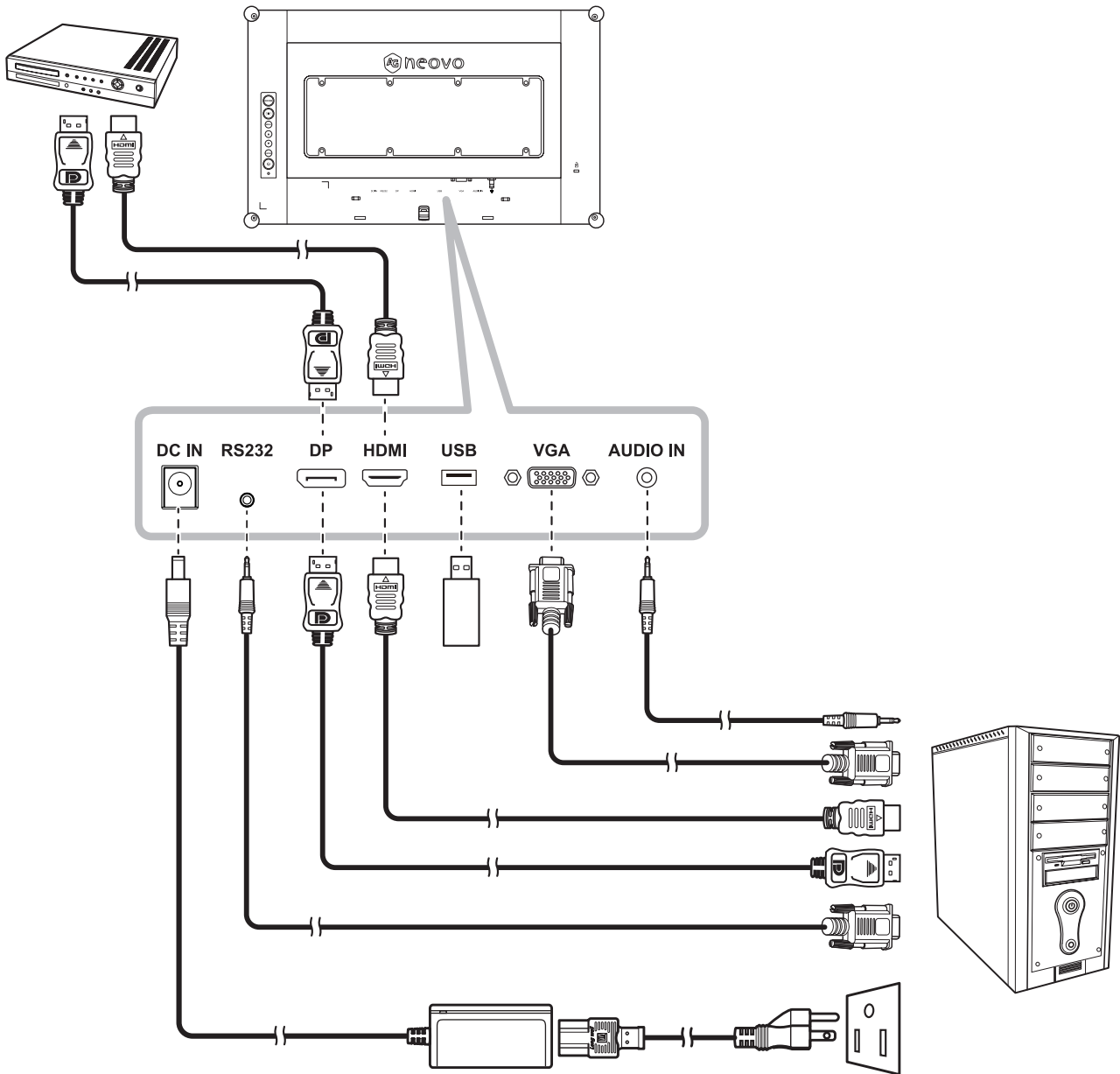

# CHAPTER 2: ON SCREEN DISPLAY MENU

## 2.1 Using the OSD Menu

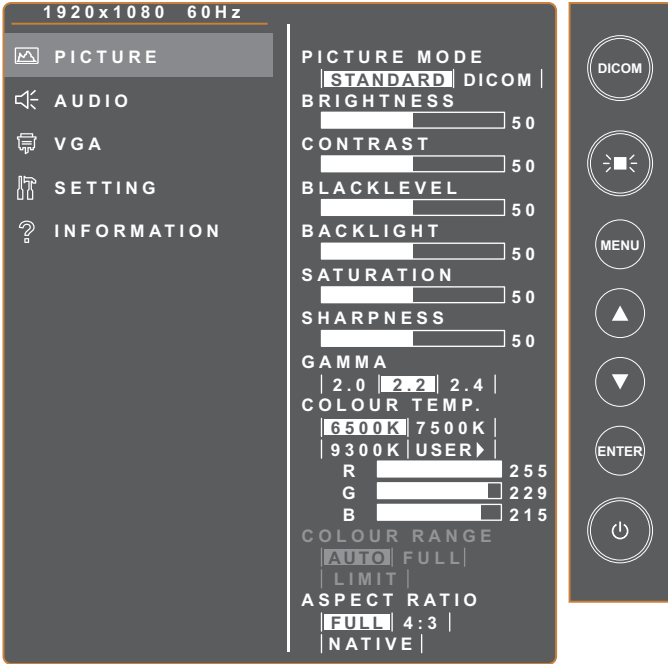
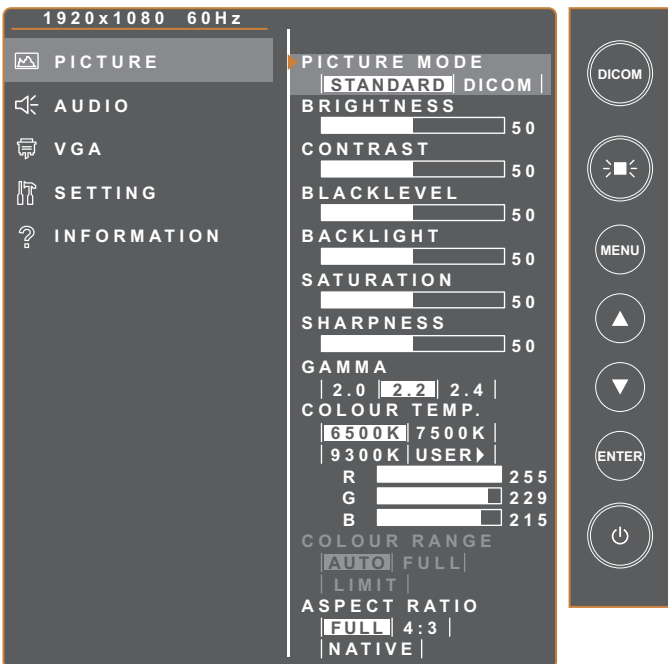
#	Menu Navigation	Operation
1	<p>Display the main menu screen.</p> 	<p>Press the <b>MENU</b> button.</p>
2	<p>Select the submenu.</p> 	<ol style="list-style-type: none"> <li>1 Press the ▲/▼ button to select the menu item.</li> <li>2 Press the <b>ENTER</b> button to enter the submenu.</li> </ol>

The highlighted item (gray) indicates the active submenu.

# ON SCREEN DISPLAY MENU

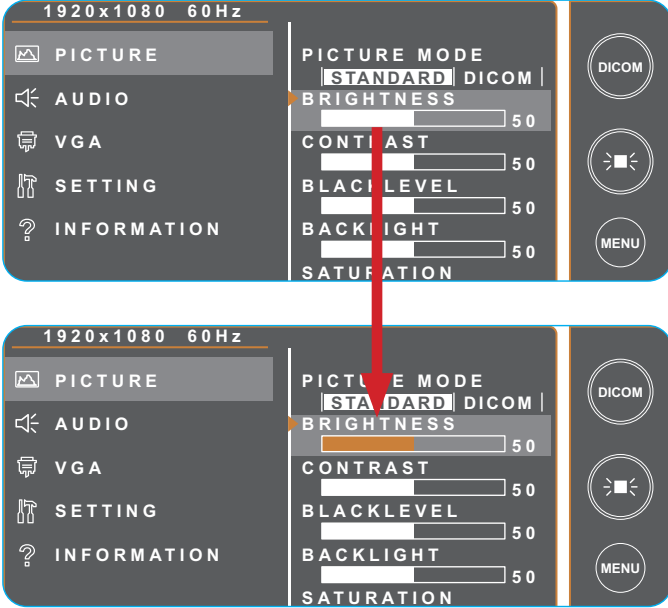
#	Menu Navigation	Operation
3	<p>Adjust the settings. The highlighted item indicates the active submenu. For example:</p> 	<ol style="list-style-type: none"> <li>1 Press the ▲/▼ button to select an option.</li> <li>2 Press the <b>ENTER</b> button to confirm.</li> <li>3 Press the ▲/▼ button to select an item or adjust the values.</li> <li>4 Press the <b>ENTER</b> button to confirm the setting.</li> </ol>
4	Exit the submenu.	Press the <b>MENU</b> button to return to the previous menu.
5	Close the OSD window.	Press the <b>MENU</b> button to return to the previous menu.

When settings are modified, all changes are saved when the user does the following:

- Proceeds to the another menu.
- Exits the OSD menu.
- Waits for the OSD menu to disappear.

## Note:

- ◆ Availability of some menu items depend on the input source signal. If the menu is not available, it is disabled and grayed out.

# ON SCREEN DISPLAY MENU

## 2.2 OSD Menu Tree

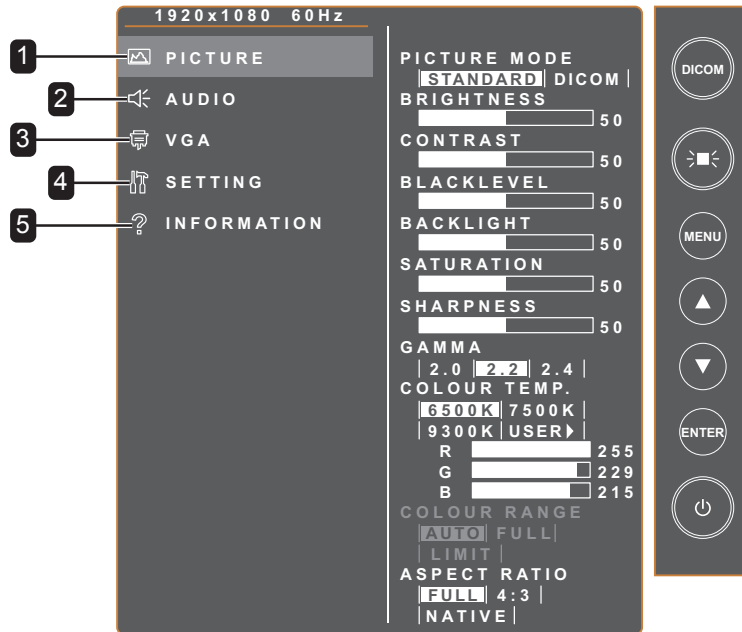

Main Menu	Submenu	Remarks
1. PICTURE	<ul style="list-style-type: none"> <li>PICTURE MODE</li> <li>BRIGHTNESS</li> <li>CONTRAST</li> <li>BLACKLEVEL</li> <li>BACKLIGHT</li> <li>SATURATION</li> <li>SHARPNESS</li> <li>GAMMA</li> <li>COLOUR TEMP.</li> <li>COLOUR RANGE</li> <li>ASPECT RATIO</li> </ul>	See page 23.
2. AUDIO	<ul style="list-style-type: none"> <li>VOLUME</li> <li>MUTE</li> </ul>	See page 25.
3. VGA	<ul style="list-style-type: none"> <li>AUTO ADJUST</li> <li>H. POSITION</li> <li>V. POSITION</li> <li>PHASE</li> <li>CLOCK</li> </ul>	See page 26.
4. SETTING	<ul style="list-style-type: none"> <li>LANGUAGE</li> <li>OSD TIMER</li> <li>OSD POSITION</li> <li>STANDBY</li> <li>SOURCE DETECT</li> <li>SERVICE UPDATE</li> <li>RESET DEFAULT</li> <li>DICOM COMPENSATE</li> <li>MONITOR ID</li> <li>sRGB</li> </ul>	See page 27.
5. INFORMATION	<ul style="list-style-type: none"> <li>INPUT</li> <li>RESOLUTION</li> <li>H- FREQ.</li> <li>V- FREQ.</li> <li>F/W VERSION</li> </ul>	See page 28.

# CHAPTER 3: ADJUSTING THE SETTINGS

## 3.1 Picture Menu

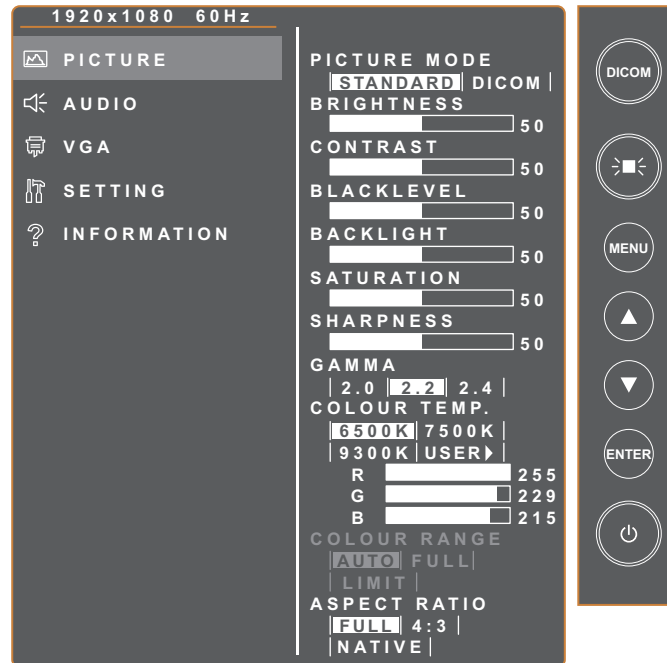

Item	Function	Range
PICTURE MODE	Set the predefined picture setting. <b>Note:</b> The following options are not available if the setting is set to <b>DICOM</b> : BRIGHTNESS / CONTRAST / BLACKLEVEL / BACKLIGHT / SATURATION / GAMMA / COLOUR RANGE	STANDARD DICOM
BRIGHTNESS	Adjust the luminance of the screen image.	0 to 100
CONTRAST	Adjust the difference between the black level and the white level.	0 to 100
BLACKLEVEL	Adjust the black level of the screen image. Low brightness setting makes black colour darker.	0 to 100
BACKLIGHT	Adjust the backlight setting.	0 to 100
SATURATION	Adjust the color saturation of the picture.	0 to 100
SHARPNESS	Adjust the clarity and focus of the screen image.	0 to 100
GAMMA	Adjust the non-linear setting for picture luminance and contrast.	2.0 2.2 2.4
COLOUR TEMP.	Select a colour temperature for the image.	6500K 7500K 9300K USER

# ADJUSTING THE SETTINGS

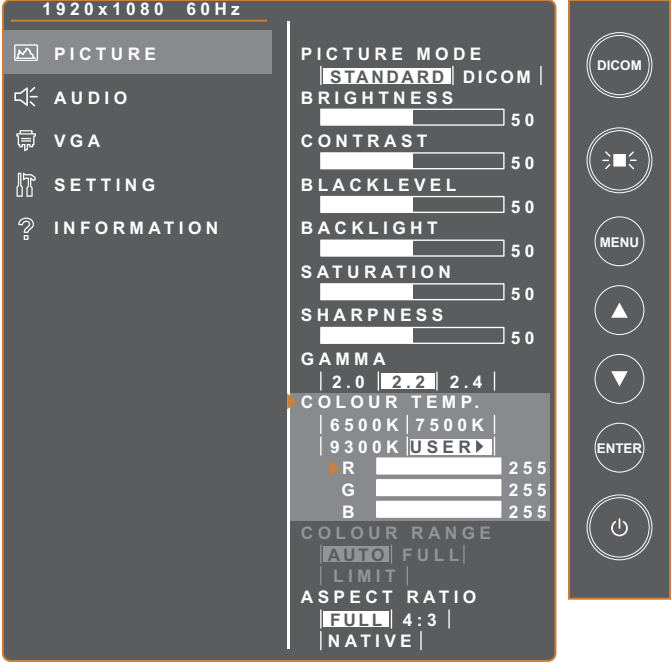
Item	Function	Range
	<p>If the COLOUR TEMP. setting is set to USER, you can customize the colour temperature by adjusting the red (R), green (G), or blue (B) setting according to your preference.</p>  <p>a. Press the ▲/▼ button to select the colour you want to adjust. Then press the <b>ENTER</b> button to enter its submenu.</p> <p>b. Press the ▲/▼ button to adjust the value (0~255). Then press the <b>ENTER</b> button.</p>	
COLOUR RANGE	Adjust black and white levels for video. <b>Note:</b> This menu item is only available for HDMI source.	AUTO FULL LIMIT
ASPECT RATIO	Select the aspect ratio of the screen image.	FULL NATIVE 4:3



# ADJUSTING THE SETTINGS

## 3.2 Audio Menu

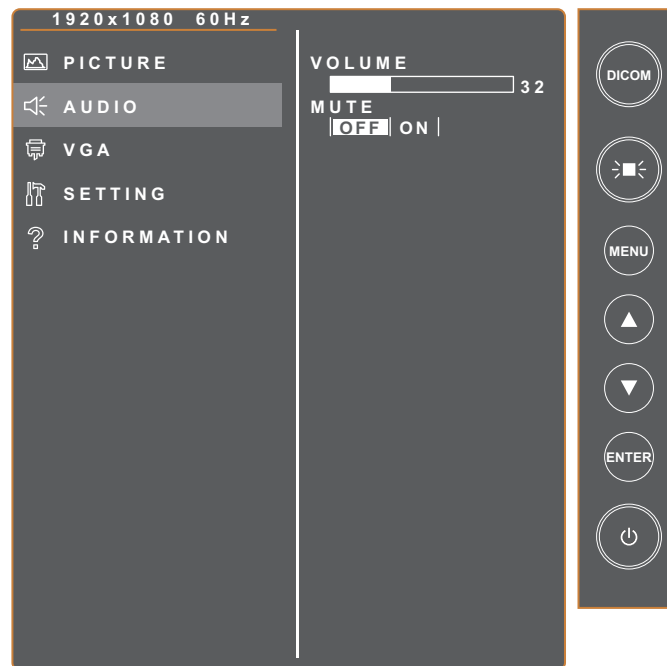

Item	Function	Range
VOLUME	Adjust the volume level.	0 to 100
MUTE	Turn the mute function on/off.	OFF ON

# ADJUSTING THE SETTINGS

## 3.3 VGA Menu

### Note:

- ◆ This menu item is only available for VGA source.

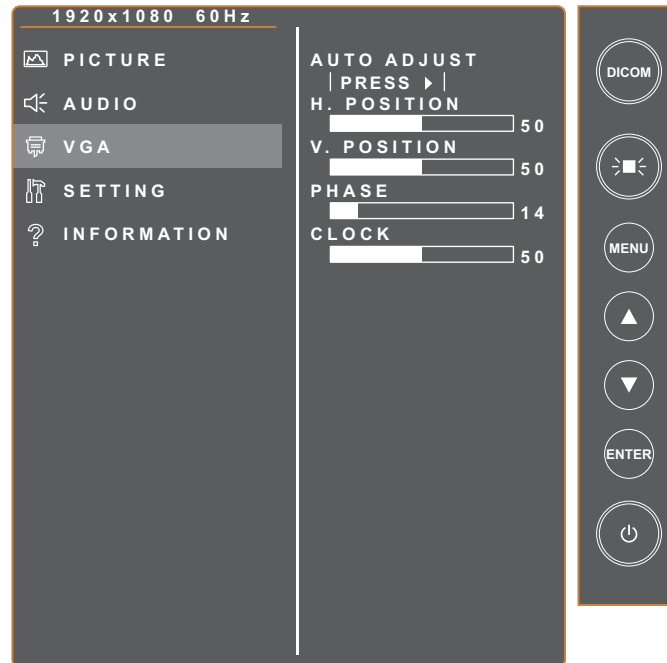

Item	Function	Range
AUTO ADJUST	Automatically tune the LCD monitor to its optimal setting, including horizontal position, vertical position, clock, and phase.	Press <b>ENTER</b>
H. POSITION	Move the screen image to the left or right.	0 to 100
V. POSITION	Move the screen image up or down.	0 to 100
PHASE	Adjust the phase timing to synchronise with the video signal.	0 to 100
CLOCK	Adjust the frequency timing to synchronise with the video signal.	0 to 100

# ADJUSTING THE SETTINGS

## 3.4 Setting Menu



Item	Function	Range
LANGUAGE	Set the OSD language.	ENGLISH ESPAÑOL FRANÇAIS DEUTSCH 繁體中文
OSD TIMER	Set the period of time the OSD menu stays on the screen.	OFF 10 SEC 20 SEC 30 SEC 40 SEC 50 SEC 60 SEC
OSD POSITION	Set the OSD menu position on the screen.	CENTER L-U L-D R-U R-D
STANDBY	Set whether or not the display automatically enters standby mode when there is no signal detected at the preset time.	OFF ON
SOURCE DETECT	Automatically the input source or manually switch the input source.	AUTO HDMI DP VGA
SERVICE UPDATE	Update the LCD monitor firmware for service.	Press <b>ENTER</b>

# ADJUSTING THE SETTINGS

Item	Function	Range
RESET DEFAULT	Reset all settings to the factory preset values.	Press <b>ENTER</b>
DICOM COMPENSATE	Different DICOM curves are provided for different ambient light variations	<b>0,1,2,3,4,5</b>
MONITOR ID	Sets the ID number for controlling the display via the RS232 connection. Each display must have a unique ID number when multiple sets of this display are connected.	<b>1~255</b>
sRGB	Adjust colors to comply with sRGB standards	OFF ON



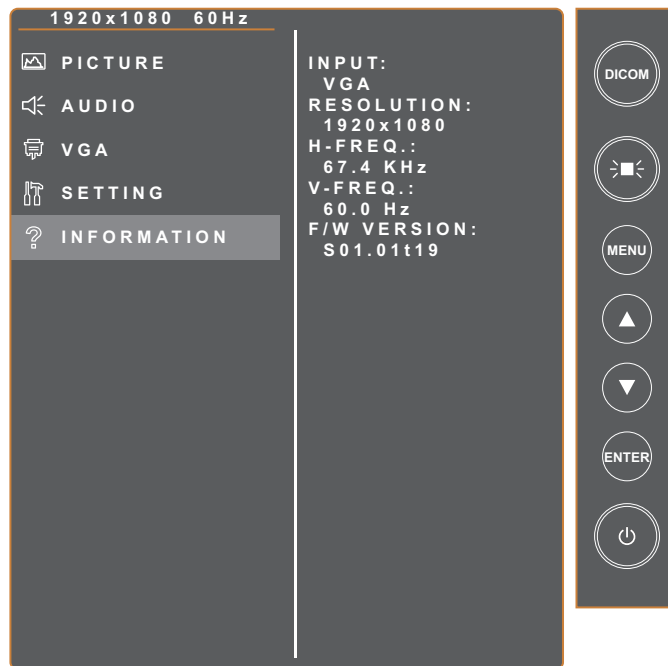





## 3.5 Information Menu



Item	Function	Range
INPUT	View the input source.	N/A
RESOLUTION	View the monitor resolution.	N/A
H- FREQ.	View the horizontal frequency.	N/A
V-FREQ.	View the vertical frequency.	N/A
F/W VERSION	View the firmware version.	N/A

# CHAPTER 4: APPENDIX

## 4.1 Warning Message

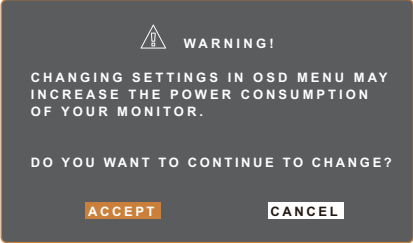
Warning Messages	Cause	Solution
<p>No signal from the current source</p>  	<p>The signal cable is not properly connected.</p>	<ul style="list-style-type: none"> <li>• Check the current signal source output.</li> <li>• Switch to another signal source.</li> <li>• Check that the relevant signal cables are well connected/ loose.</li> </ul>
<p>LightBox function <b>Activate</b> and <b>Disable</b> pop-up windows</p>  	<p>The monitor will execute or disable the LightBox function.</p>	<p>Toggle the  button to enable/disable the function.</p>
<p>DICOM function <b>Activate</b> and <b>Disable</b> pop-up windows</p>  	<p>The monitor will execute or disable the DICOM function.</p>	<p>Toggle the <b>DICOM</b> button to enable/disable the function.</p>
<p>Cannot update the firmware</p>  	<ul style="list-style-type: none"> <li>• There is no USB disk drive is inserted into the USB connector of the LCD monitor.</li> <li>• There no firmware file is stored in the installed USB disk drive.</li> </ul>	<p>Copy the firmware file to the root directory of the USB disk drive. Then insert the USB disk drive into the USB connector.</p>
<p>Warning message pops out</p> 	<p>This warning message pops up only when the function in the <b>SETTING</b> menu is changed for the first time.</p>	<p>Press the <b>ENTER</b> button (the "ACCEPT" tab is selected by default) to continue the setting changes, or select the "CANCEL" tab and press the <b>ENTER</b> button to disable the setting changes.</p> <p><b>Note:</b> The operation may vary from different product models.</p>

# APPENDIX

## 4.2 Supported Resolutions

Resolution	Horizontal Frequency (kHz)	Bandwidth (MHz)	Polarity	
			H	V
VGA 720x400 70Hz	31.47	28.322	-	+
VGA 640x480 60Hz	31.47	25.175	-	-
MAC 640x480 67Hz	35	32.24	-	-
VESA 640x480 72Hz	37.86	31.5	-	-
VESA 640x480 75Hz	37.5	31.5	-	-
VESA 800x600 56Hz	35.16	36	+	+
VESA 800x600 60Hz	37.88	40	+	+
VESA 800x600 75Hz	46.88	49.5	+	+
VESA 800x600 72Hz	48.08	50	+	+
MAC 832x624 75Hz	49.72	57.283	-	-
VESA 1024x768 60Hz	48.36	65	-	-
VESA 1024x768 70Hz	56.48	75	-	-
VESA 1024x768 75Hz	60.02	78.75	+	+
SXGA 1280x1024 60Hz	64	108	+	+
SXGA 1280x1024 75Hz	80	135	+	+
SXGA 1152x864 75Hz	67.5	108	+	+
SXGA 1280x960 60Hz	60	108	+	+
WXGA+ 1440x900 60Hz	56	106.5	-	+
WXGA+ 1440x900 75Hz	70.6	136.75	-	+
WSXGA+ 1680x1050 60Hz	65.2	146	-	+
WSXGA+ 1680x1050 75Hz	82.3	187	-	+
VESA 1280x 768 60Hz	47.776	79.5	-	+
1920X1080 60Hz	67.5	148.5	+	+

## 4.3 Cleaning

### Caution When Using the Monitor

- Do not bring your hands, face or objects close to the ventilation holes of the monitor. The top of the monitor is usually very hot due to the high temperature of exhaust air being released through the ventilation holes. Burns or personal injuries may occur if any body parts are brought too close. Placing any object near the top of the monitor could also result in heat related damage to the object as well as the monitor itself.
- Be sure to disconnect all cables before moving the monitor. Moving the monitor with its cables attached may damage the cables and thus cause fire or electric shock.
- Disconnect the power plug from the wall outlet as a safety precaution before carrying out any type of cleaning or maintenance procedure.

### Front Panel Cleaning Instructions

- The front of the monitor has been specially treated. Wipe the surface gently using only a cleaning cloth or a soft, lint-free cloth.
- If the surface becomes dirty, soak a soft, lint-free cloth in a mild detergent solution. Wring the cloth to remove excess liquid. Wipe the surface of the monitor to remove dirt. Then use a dry cloth of the same type to dry.
- Do not scratch or hit the surface of the panel with fingers or hard objects of any kind.
- Do not use volatile substances such as insect sprays, solvents and thinners.

### Cabinet Cleaning Instructions

- If the cabinet becomes dirty, wipe the cabinet with a soft, dry cloth.
- If the cabinet is extremely dirty, soak a lint-free cloth in a mild detergent solution. Wring the cloth to remove as much moisture as possible. Wipe the cabinet. Use another dry cloth to wipe over until the surface is dry.
- Do not allow any water or detergent to come into contact with the surface of the monitor. If water or moisture gets inside the unit, operating problems, electrical and shock hazards may result.
- Do not scratch or hit the cabinet with fingers or hard objects of any kind.
- Do not use volatile substances such as insect sprays, solvents and thinners on the cabinet.
- Do not place anything made from rubber or PVC near the cabinet for any extended periods of time.

# APPENDIX

## 4.4 Troubleshooting

Follow the solutions below to solve these common problems, and contact us if the problem persists.

Symptom	Possible Cause and Solution
The Power LED indicator is OFF.	<ul style="list-style-type: none"> <li>• Check if the LCD monitor is turned ON.</li> <li>• Check if the power cord is properly connected to the LCD monitor.</li> <li>• Check if the power cord is plugged into the power outlet.</li> </ul>
The Power LED indicator is AMBER.	<ul style="list-style-type: none"> <li>• Check if the computer is turned ON.</li> <li>• Check if the computer is in standby mode, move the mouse or press any key to wake up the computer.</li> </ul>
The displayed texts are blurry.	<ul style="list-style-type: none"> <li>• Configure the PICTURE menu settings. See page 23~24.</li> <li>• For VGA input, execute the AUTO ADJUST function. See page 26.</li> </ul>
Image position is incorrect.	<ul style="list-style-type: none"> <li>• For VGA input, adjust the H. POSITION and V. POSITION settings. See page 26.</li> </ul>
The screen turns white.	<ul style="list-style-type: none"> <li>• Check if the LIGHT BOX function is turned ON. Press the  button to disable the function.</li> </ul>
Flickering picture or picture with ripples.	<ul style="list-style-type: none"> <li>• There may be electrical appliances or equipment with electronic disturbance. Try to relocate the LCD monitor or replace the power socket at another location.</li> </ul>
Dim or extremely bright screen.	<ul style="list-style-type: none"> <li>• Adjust the brightness/contrast settings. See page 23.</li> <li>• Check if the DICOM function is turned ON. Press the <b>DICOM</b> button to disable the function.</li> </ul>
The displayed picture looks distorted.	<ul style="list-style-type: none"> <li>• Configure the aspect ratio setting. See page 24.</li> </ul>
Picture with colour difference.	<ul style="list-style-type: none"> <li>• Adjust the color temperature settings. See page 23.</li> </ul>
No audio output.	<ul style="list-style-type: none"> <li>• Configure the audio settings. See page 25.</li> <li>• Check if the audio cable is properly connected to the LCD monitor.</li> </ul>



# CHAPTER 5: SPECIFICATIONS

## 5.1 Monitor Specifications

DR-2202		
Panel	Panel Type	LED-Backlit TFT LCD (IPS Technology)
	Panel Size	21.5"
	Max. Resolution	FHD 1920 x 1080
	Pixel Pitch	0.248 mm
	Brightness	500 cd/m <sup>2</sup>
	DICOM Brightness	300 cd/m <sup>2</sup> (Preset)
	Contrast Ratio	1000:1
	Viewing Angle (H/V)	178°/178°
	Display Colour	16.7M (True 8 bits)
	Response Time	5 ms
	Surface Treatment	Anti-Glare Treatment (Haze 25%), 3H Hard Coating
Frequency (H/V)	H Freq.	31 kHz-84 kHz
	V Freq.	56 Hz-75 Hz
Input	DisplayPort	x 1
	HDMI	1.4 x 1
	VGA	15-Pin D-Sub x 1
External Control	RS232 In	Stereo Audio Jack (3.5 mm)
Other Connectivity	USB	2.0 x 1 (Service Port)
Audio	Audio In	Stereo Audio Jack (3.5 mm)
	Internal Speaker	3W x 2
Power	Power Supply	External
	Power Requirements	DC 12V, 5.0A
	On Mode	15W (On)
	Stand-by Mode	< 0.5W
	Off Mode	< 0.3W
Glass	Thickness	1.8 mm
	Reflection Rate	< 1%
	Transmission Rate	> 97%
	MOHS Hardness	6
	Pencil Hardness	9H
	IK Rating	IK07
Operating Conditions	Temperature	0°C-40°C (32°F-104°F)
	Humidity	10%-90% (non-condensing)
Storage Conditions	Temperature	-20°C-60°C (-4°F-144°F)
	Humidity	5%-95% (non-condensing)
DICOM		Yes
Mounting	VESA FPMPI	Yes (100 x 100 mm & 300 x 100 mm)
Security	Kensington Security Slot	Yes
Dimensions	Product w/o Base (W x H x D)	528.4 x 325.5 x 48.2 mm (20.8" x 12.8" x 1.9")
	Packaging (W x H x D)	610.0 x 405.0 x 160.0 mm (24.0" x 15.9" x 6.3")
Weight	Product w/o Base	4.7 kg (10.4 lbs)
	Product	6.45 kg (14.2 lbs)

### Note:

- ◆ All specifications are subject to change without prior notice.

# SPECIFICATIONS

## 5.2 Monitor Dimensions

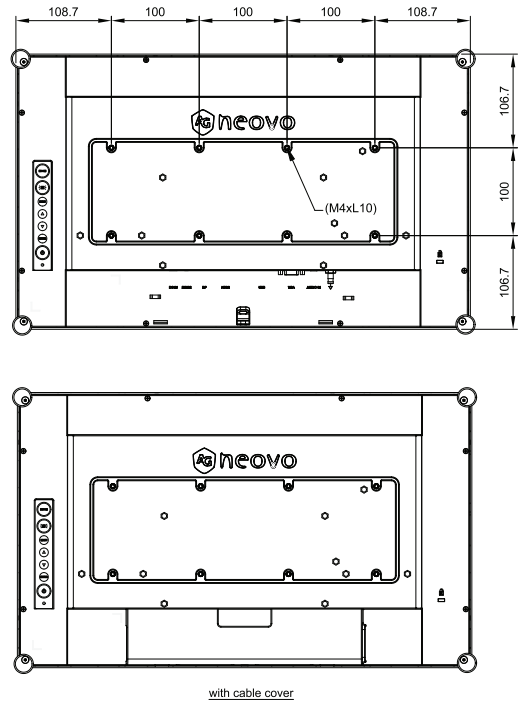
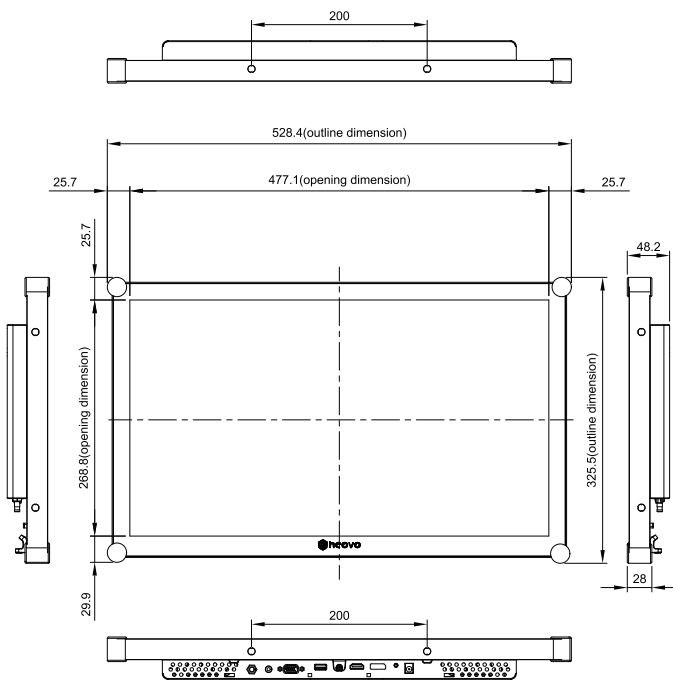

### AG Neovo

Company Address: 5F-1, No. 3-1, Park Street, Nangang District, Taipei, 11503, Taiwan.

Copyright © 2025 AG Neovo. All rights reserved.

DR-2202 Eprel registration number: 1961931

DR2220\_UM\_V011