



**THE DISPLAY CHOICE
OF PROFESSIONALS™**

**IFP6504P-AO, IFP7504P-AO & IFP8604P-AO
UHD Interactive Display**

www.agneovo.com

User Manual

TABLE OF CONTENTS

SAFETY INFORMATION	1
Federal Communications Commission (FCC) Notice (U.S. Only).....	1
Polish Center for Testing and Certification Notice	1
Electric, Magnetic and Electromagnetic Fields ("EMF").....	2
Information for U.K. only.....	3
North Europe (Nordic Countries) Information.....	4
End-of-Life Disposal	5
Waste Electrical and Electronic Equipment-WEEE.....	5
Turkey RoHS	6
Ukraine RoHS	6
PRECAUTIONS	7
Cautions When Setting Up	7
Cautions When Using.....	8
Cleaning and Maintenance.....	8
Notice for the Interactive Display.....	9
Caring for the Touch Screen.....	9
CHAPTER 1: PRODUCT DESCRIPTION.....	10
1.1 Unpacking	10
1.2 Package Contents	10
1.3 Preparing for the Installation	11
1.4 Wall Mounting Installation.....	12
1.4.1 VESA Grid	13
1.4.2 Mounting the Interactive Display on the Wall.....	13
1.4.3 Ventilation Requirements for Enclosure Locating	15
1.5 Mounting the Interactive Display on the Stand.....	16
1.6 Installing the Wi-Fi Module	21
1.7 Inserting an OPS Module	23
1.8 Using the Active Pen	23
1.8.1 Button Functions and LED Light	23
1.8.2 Installing the Battery.....	24
1.8.3 Pairing with the Active Pen	25
1.9 Placing the Stylus & Active Pen	25
1.10 Interactive Display Overview	26
1.10.1 Front Panel.....	26
1.10.2 Input/Output Terminals	27
1.11 Remote Control	29
1.11.1 General Functions	29
1.11.2 Inserting the Batteries in the Remote Control.....	30
1.11.3 Handling the Remote Control	30
1.11.4 Operating Range of the Remote Control	31

TABLE OF CONTENTS

CHAPTER 2: MAKING CONNECTIONS.....	32
2.1 Connection Diagram.....	32
CHAPTER 3: USING THE INTERACTIVE DISPLAY	33
3.1 Using the Touchscreen.....	33
3.2 Using the On-Screen Keyboard	37
3.3 Initial Setup.....	37
3.3.1 Unhiding the Sidebar.....	38
3.3.2 Switching to the Standard Home Screen	39
CHAPTER 4: USING THE SYSTEM.....	42
4.1 About the Home Screen	42
4.2 Using the Sidebar menu.....	43
4.3 Configuring System Settings.....	46
CHAPTER 5: USING THE APPS.....	51
5.1 Accessing Apps	51
5.2 Meetboard	51
5.3 Montage	55
5.4 File Manager	58
5.5 Annotation	60
5.6 ScreenShot.....	61
5.7 Camera.....	61
CHAPTER 6: APPENDIX.....	62
6.1 Warning Messages.....	62
6.2 Supported Media Formats.....	62
6.3 Supported Resolution.....	65
6.4 Troubleshooting.....	67
CHAPTER 7: SPECIFICATIONS	69
7.1 Display Specifications	69
7.2 Display Dimensions.....	70

SAFETY INFORMATION

Federal Communications Commission (FCC) Notice (U.S. Only)



This equipment has been tested and found to comply with the limits for a Class B digital device, pursuant to part 15 of the FCC Rules. These limits are designed to provide reasonable protection against harmful interference in a residential installation. This equipment generates, uses and can radiate radio frequency energy and, if not installed and used in accordance with the instructions, may cause harmful interference to radio communications. However, there is no guarantee that interference will not occur in a particular installation. If this equipment does cause harmful interference to radio or television reception, which can be determined by turning the equipment off and on, the user is encouraged to try to correct the interference by one or more of the following measures:

- Reorient or relocate the receiving antenna.
- Increase the separation between the equipment and receiver.
- Connect the equipment into an outlet on a circuit different from that to which the receiver is connected.
- Consult the dealer or an experienced radio/TV technician for help.



Changes or modifications not expressly approved by the party responsible for compliance could void the user's authority to operate the equipment.

Use only an RF shielded cable that was supplied with the display when connecting this display to a computer device.

To prevent damage which may result in fire or shock hazard, do not expose this appliance to rain or excessive moisture.

THIS CLASS B DIGITAL APPARATUS MEETS ALL REQUIREMENTS OF THE CANADIAN INTERFERENCE-CAUSING EQUIPMENT REGULATIONS.



This device complies with Part 15 of the FCC Rules. Operation is subject to the following two conditions: (1) this device may not cause harmful interference, and (2) this device must accept any interference received, including interference that may cause undesired operation.

Polish Center for Testing and Certification Notice

The equipment should draw power from a socket with an attached protection circuit (a three-prong socket). All equipment that works together (computer, display, printer, and so on) should have the same power supply source.

The phasing conductor of the room's electrical installation should have a reserve short-circuit protection device in the form of a fuse with a nominal value no larger than 16 amperes (A).

To completely switch off the equipment, the power supply cable must be removed from the power supply socket, which should be located near the equipment and easily accessible.

A protection mark "B" confirms that the equipment is in compliance with the protection usage requirements of standards PN-93/T-42107 and PN-89/E-06251.

SAFETY INFORMATION

Wymagania Polskiego Centrum Badań i Certyfikacji

Urządzenie powinno być zasilane z gniazda z przyłączonym obwodem ochronnym (gniazdo z kołkiem). Współpracujące ze sobą urządzenia (komputer, monitor, drukarka) powinny być zasilane z tego samego źródła.

Instalacja elektryczna pomieszczenia powinna zawierać w przewodzie fazowym rezerwową ochronę przed zwarciami, w postaci bezpiecznika o wartości znamionowej nie większej niż 16A (amperów).

W celu całkowitego wyłączenia urządzenia z sieci zasilania, należy wyjąć wtyczkę kabla zasilającego z gniazdka, które powinno znajdować się w pobliżu urządzenia i być łatwo dostępne.

Znak bezpieczeństwa "B" potwierdza zgodność urządzenia z wymaganiami bezpieczeństwa użytkownika zawartymi w PN-93/T-42107 i PN-89/E-06251.

Pozostałe instrukcje bezpieczeństwa

- Nie należy używać wtyczek adapterowych lub usuwać kołka obwodu ochronnego z wtyczki. Jeżeli konieczne jest użycie przedłużacza to należy użyć przedłużacza 3-żyłowego z prawidłowo połączonym przewodem ochronnym.
- System komputerowy należy zabezpieczyć przed nagłymi, chwilowymi wzrostami lub spadkami napięcia, używając eliminatora przepięć, urządzenia dopasowującego lub bezzakłócenowego źródła zasilania.
- Należy upewnić się, aby nic nie leżało na kablach systemu komputerowego, oraz aby kable nie były umieszczone w miejscu, gdzie można byłoby na nie nadeptywać lub potykać się o nie.
- Nie należy rozlewać napojów ani innych płynów na system komputerowy.
- Nie należy wpychać żadnych przedmiotów do otworów systemu komputerowego, gdyż może to spowodować pożar lub porażenie prądem, poprzez zwarcie elementów wewnętrznych.
- System komputerowy powinien znajdować się z dala od grzejników i źródeł ciepła. Ponadto, nie należy blokować otworów wentylacyjnych. Należy unikać kładzenia luźnych papierów pod komputer oraz umieszczania komputera w ciasnym miejscu bez możliwości cyrkulacji powietrza wokół niego.

Electric, Magnetic and Electromagnetic Fields ("EMF")

- We manufacture and sell many products targeted at consumers, which, like any electronic apparatus, in general have the ability to emit and receive electromagnetic signals.
- One of our leading Business Principles is to take all necessary health and safety measures for our products, to comply with all applicable legal requirements and to stay well within the EMF standards applicable at the time of producing the products.
- We are committed to develop, produce and market products that cause no adverse health effects.
- We confirm that if its products are handled properly for their intended use, they are safe to use according to scientific evidence available today.
- We play an active role in the development of international EMF and safety standards, enabling us to anticipate further developments in standardization for early integration in its products.

SAFETY INFORMATION

Information for U.K. only

WARNING - THIS APPLIANCE MUST BE EARTHED.

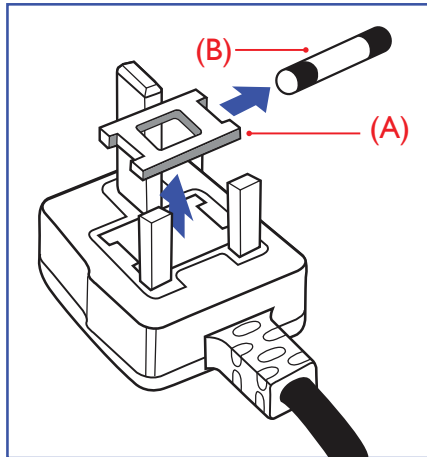

Important:

This apparatus is supplied with an approved moulded 13A plug. To change a fuse in this type of plug proceed as follows:

- 1 Remove fuse cover and fuse.
- 2 Fit new fuse which should be a BS 1362 5A, A.S.T.A. or BSI approved type.
- 3 Refit the fuse cover.

If the fitted plug is not suitable for your socket outlets, it should be cut off and an appropriate 3-pin plug fitted in its place.

If the mains plug contains a fuse, this should have a value of 5A. If a plug without a fuse is used, the fuse at the distribution board should not be greater than 5A.



Note:

The severed plug must be destroyed to avoid a possible shock hazard should it be inserted into a 13A socket elsewhere.

SAFETY INFORMATION

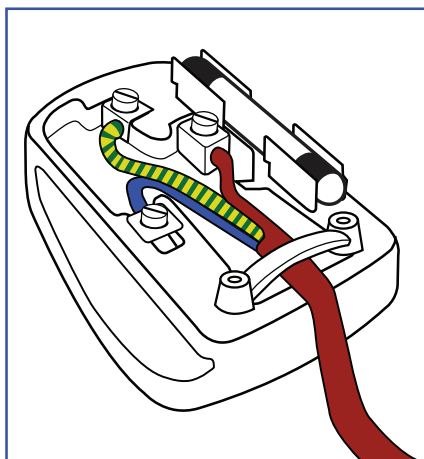

How to connect a plug

The wires in the mains lead are coloured in accordance with the following code:

BLUE - "NEUTRAL" ("N")

BROWN - "LIVE" ("L")

GREEN & YELLOW - "EARTH" ("E")

- The GREEN & YELLOW wire must be connected to the terminal in the plug which is marked with the letter "E" or by the Earth symbol or coloured GREEN or GREEN & YELLOW.
- The BLUE wire must be connected to the terminal which is marked with the letter "N" or coloured BLACK.
- The BROWN wire must be connected to the terminal which marked with the letter "L" or coloured RED.

Before replacing the plug cover, make certain that the cord grip is clamped over the sheath of the lead - not simply over the three wires.

North Europe (Nordic Countries) Information

Placering/Ventilation

WARNING: FÖRSÄKRA DIG OM ATT HUVUDBRYTARE OCH UTTAG ÄR LÄTÅTKOMLIGA, NÄR DU STÄLLER DIN UTRUSTNING PÅPLATS.

Placering/Ventilation

ADVARSEL: SØRG VED PLACERINGEN FOR, AT NETLEDNINGENS STIK OG STIKKONTAKT ER NEMT TILGÆNGLIGE.

Paikka/Ilmankierto

VAROITUS: SIJOITA LAITE SITEN, ETTÄ VERKKOJOHTO VOIDAAN TARVITTAESSA HELPOSTI IRROTTAA PISTORASIESTA.

Plassering/Ventilasjon

ADVARSEL: NÅR DETTE UTSTYRET PLASSERES, MÅ DU PASSE PÅ AT KONTAKTENE FOR STØMTILFØRSEL ER LETTE Å NÅ.

SAFETY INFORMATION

End-of-Life Disposal

Your new Public Information Display contains materials that can be recycled and reused. Specialized companies can recycle your product to increase the amount of reusable materials and to minimize the amount to be disposed of.

Please find out about the local regulations on how to dispose of your old display from your local dealer.

(For customers in Canada and U.S.A.)

This product may contain lead and/or mercury. Dispose of in accordance to local-state and federal regulations. For additional information on recycling contact www.eia.org (Consumer Education Initiative).

Waste Electrical and Electronic Equipment-WEEE

Attention users in European Union private households



This marking on the product or on its packaging illustrates that, under European Directive 2012/19/EU governing used electrical and electronic appliances, this product may not be disposed of with normal household waste. You are responsible for disposal of this equipment through a designated waste electrical and electronic equipment collection. To determine the locations for dropping off such waste electrical and electronic, contact your local government office, the waste disposal organization that serves your household or the store at which you purchased the product.

Attention users in United States:

Please dispose of according to all Local, State and Federal Laws. For the disposal or recycling information, contact: www.mygreenelectronics.com or www.eiae.org.

End of Life Directives-Recycling



Your new Public Information Display contains several materials that can be recycled for new users.

Please dispose of according to all Local, State, and Federal laws.

Restriction on Hazardous Substances statement (India)

This product complies with the "India E-waste Rule 2011" and prohibits use of lead, mercury, hexavalent chromium, polybrominated biphenyls or polybrominated diphenyl ethers in concentrations exceeding 0.1 weight % and 0.01 weight % for cadmium, except for the exemptions set in Schedule 2 of the Rule.

E-Waste Declaration for India



This symbol on the product or on its packaging indicates that this product must not be disposed of with your other household waste. Instead it is your responsibility to dispose of your waste equipment by handing it over to a designated collection point for the recycling of waste electrical and electronic equipment. The separate collection and recycling of your waste equipment at the time of disposal will help to conserve natural resources and ensure that it is recycled in a manner that protects human health and the environment.

SAFETY INFORMATION

Batteries



For EU: The crossed-out wheeled bin implies that used batteries should not be put to the general household waste! There is a separate collection system for used batteries, to allow proper treatment and recycling in accordance with legislation.

Please contact your local authority for details on the collection and recycling schemes.

For Switzerland: The used battery is to be returned to the selling point.

For other non-EU countries: Please contact your local authority for correct method of disposal of the used battery.

According to EU directive 2006/66/EC, the battery can't be disposed improperly. The battery shall be separated to collect by local service.

Turkey RoHS

Türkiye Cumhuriyeti: EEE Yönetmeliğine Uygundur.

Ukraine RoHS

Обладнання відповідає вимогам Технічного регламенту щодо обмеження використання деяких небезпечних речовин в електричному та електронному обладнанні, затвердженого постановою Кабінету Міністрів України від 3 грудня 2008 № 1057.

PRECAUTIONS

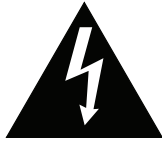

Symbols used in this manual

	This icon indicates the existence of a potential hazard that could result in personal injury or damage to the product.
	This icon indicates important operating and servicing information.

Notice

- Read this User Manual carefully before using the interactive display and keep it for future reference.
- The product specifications and other information provided in this User Manual are for reference only. All information is subject to change without notice. Updated content can be downloaded from our web site at www.agneovo.com.
- To protect your rights as a consumer, do not remove any stickers from the interactive display. Doing so may affect the determination of the warranty period.

Cautions When Setting Up

- Do not place the interactive display near heat sources, such as a heater, exhaust vent, or in direct sunlight.
- Do not cover or block the ventilation holes in the housing.
- Place the interactive display on a stable area. Do not place the interactive display where it may subject to vibration or shock.
- Place the interactive display in a well-ventilated area.
- Do not place the interactive display outdoors.
- To avoid the risk of shock or permanent damage to the set, do not expose the display to dust, rain, water or an excessively moist environment.
- Do not spill liquid or insert sharp objects into the interactive display through the ventilation holes. Doing so may cause accidental fire, electric shock or damage the interactive display.

PRECAUTIONS

Cautions When Using

- Use only the power cord supplied with the interactive display.
- The power outlet should be installed near the interactive display and be easily accessible.
- If an extension cord is used with the interactive display, ensure that the total current consumption plugged into the power outlet does not exceed the ampere rating.
- Do not allow anything to rest on the power cord. Do not place the interactive display where the power cord may be stepped on.
- If the interactive display will not be used for an indefinite period of time, unplug the power cord from the power outlet.
- To disconnect the power cord, grasp and pull by the plug head. Do not tug on the cord; doing so may cause fire or electric shock.
- Do not unplug or touch the power cord with wet hands.
- When turning off the display by detaching the power cord, wait 6 seconds before re-attaching the power cord for normal operation.
- Do not knock or drop the display during operation or transportation.

Cleaning and Maintenance

- To protect your display from possible damage, do not put excessive pressure on the interactive display. When moving your display, grasp the frame to lift; do not lift the display by placing your hand or fingers on the interactive display.
- For cleaning the touch screen, refer to page 9.
- If your display becomes wet, wipe it with dry cloth as soon as possible.
- If a foreign substance or water gets in your display, turn the power off immediately and disconnect the power cord. Then remove the foreign substance or water, and send the unit to the maintenance center.
- In order to maintain the best performance of your display and ensure a longer lifetime, we strongly recommend using the display in a location that falls within the following temperature and humidity ranges.
 - ◆ Temperature: 0°C-40°C (32°F-104°F)
 - ◆ Humidity: 20%-80% (non-condensing)



Warning:



Unplug the power cord from the power outlet and refer to qualified service

personnel under the following conditions:

- ◆ When the power cord is damaged.
- ◆ If the interactive display has been dropped or the housing has been damaged.
- ◆ If the interactive display emits smoke or a distinct odor.

PRECAUTIONS

Notice for the Interactive Display

- In order to maintain the stable luminous performance, it is recommended to use low brightness setting.
- Due to the lifespan of the lamp, it is normal that the brightness quality of the interactive display may decrease with time.
- When static images are displayed for long periods of time, the image may cause an imprint on the interactive display. This is called image retention or burn-in.
 - ◆ To prevent image retention, do any of the following:
 - Set the interactive display to turn off after a few minutes of being idle.
 - Use a screen saver that has moving graphics or a blank white image.
 - Switch desktop backgrounds regularly.
 - Adjust the interactive display to low brightness settings.
 - Turn off the interactive display when the system is not in use.
 - ◆ Things to do when the interactive display shows image retention:
 - Turn off the interactive display for extended periods of time. It can be several hours or several days.
 - Use a screen saver and run it for extended periods of time.
 - Use a black and white image and run it for extended periods of time.
- There are millions of micro transistors inside the interactive display. It is normal for a few transistors to be damaged and to produce spots. This is acceptable and is not considered a failure.
- **IMPORTANT:** Always activate a moving screen saver program when you leave your display unattended. Always activate a periodic screen refresh application if the unit will display unchanging static content. Uninterrupted display of still or static images over an extended period may cause “burn in”, also known as “after-imaging” or “ghost imaging”, on your screen. This is a well-known phenomenon in Interactive display technology. In most cases, the “burned in” or “after-imaging” or “ghost imaging” will disappear gradually over a period of time after the power has been switched off.
- **WARNING:** Severe “burn-in” or “after-image” or “ghost image” symptoms will not disappear and cannot be repaired. This is also not covered under the terms of your warranty.

Caring for the Touch Screen

Use the following recommendations to care for the touch screen.

- Before cleaning the screen, make sure the interactive display is switched off and the power cord is unplugged from the wall outlet.
- Remove dirt or dust from the screen regularly. It is recommended to use a small amount of alcohol as cleaning agent.
- To avoid damage to the screen, never use any aggressive solvents or scrubbing agents.
- Wipe the screen gently using a lint-free cloth moistened in the cleaning agent.
- Never spray the cleaning agent on the screen surface or the body directly as it may cause short circuit to the touch screen.
- Do not expose the display to direct sunlight or strong light source during use.

CHAPTER 1: PRODUCT DESCRIPTION

1.1 Unpacking

- This product is packed in a packaging box which contains standard accessories.
- Any other optional accessories will be packed separately.
- Considering the size and weight of the display, it is recommended that this product is carried out by two persons.
- After opening the packaging box, ensure that the included items are in good condition and complete.

1.2 Package Contents

When unpacking, check if the following items are included in the package. If any of them is missing or damaged, contact your dealer.

Interactive Display



Remote Control

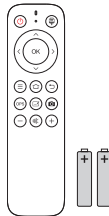

Quick Start Guide



**Power Cord (US)
(Optional)**

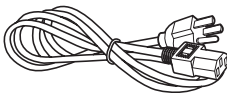

**Power Cord x2
(UK & EU) (Optional)**

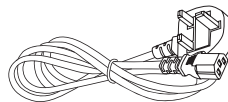

Warning Information



**USB Cable
(for touch control)**

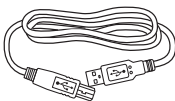

USB-C Cable

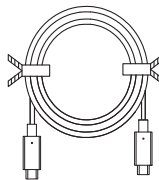

HDMI Cable

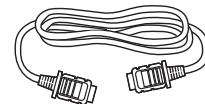

Stylus x2

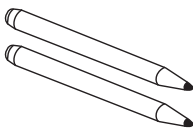

Active Pen

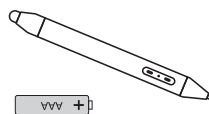

**Wi-Fi Module &
Antennas**

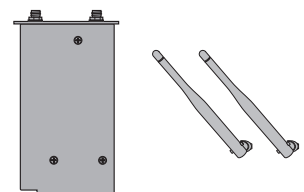

**Wall Mount Screw
Package**

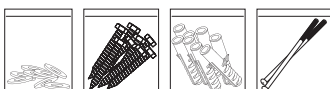

PRODUCT DESCRIPTION

Note:

- ◆ Remote control and active pen are shipped with the supplied AAA batteries.
- ◆ For all other regions, apply a power cord that conforms to the AC voltage of the power socket and has been approved by and complies with the safety regulations of the particular country (Type H05W-F, 2G or 3G, 0.75 or 1 mm² should be used).
- ◆ You might like to save the package box and packing material for shipping the display.
- ◆ The pictures are for reference only. Actual items may vary upon shipment.

1.3 Preparing for the Installation

- Due to the high power consumption, always use the plug exclusively designed for this product. If an extended line is required, please consult your service agent.
- The product should be installed on a flat surface to avoid tipping. The distance between the back of the product and the wall should be maintained for proper ventilation. Avoid installing the product in the kitchen, bathroom or any other places with high humidity so as not to shorten the service life of the electronic components.
- The product can normally operate only under 3600m in altitude. In installations at altitudes above 3600m, some abnormalities may be experienced.



Warning:

- ◆ Do not press too hard on the Interactive display or edge of the frame, as this may cause the device to malfunction.

PRODUCT DESCRIPTION

1.4 Wall Mounting Installation

To mount this display to a wall, you will have to obtain a standard wall-mounting kit (commercially available). We recommend using a mounting interface that complies with TUV-GS and/or UL1678 standard in North America.

To wall-mount the interactive display, screw the mounting bracket to the VESA holes at the rear of the interactive display.

IFP6504P-AO

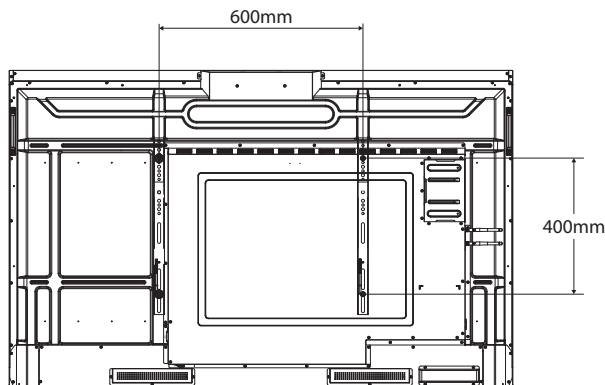

IFP7504P-AO

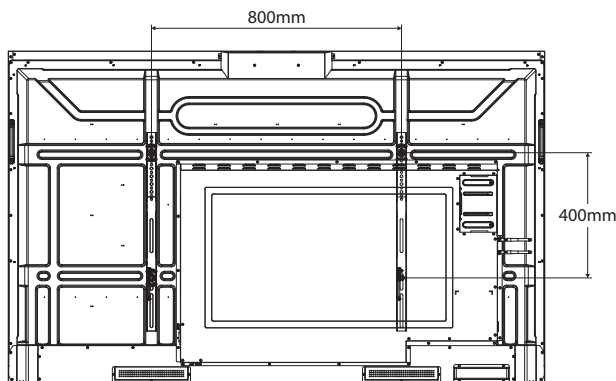

IFP8604P-AO

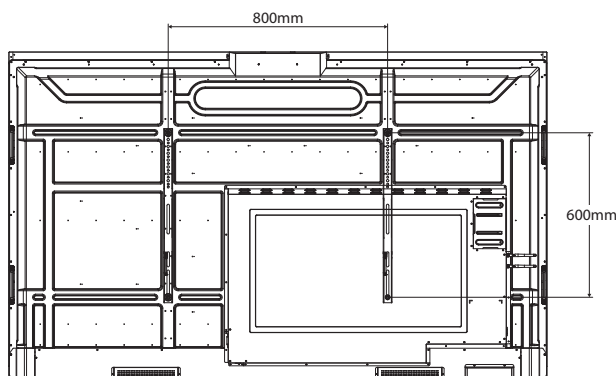

Note:

- ◆ Avoid the wall-mounting kit to block the ventilation holes on the back of the display.
- ◆ Secure the interactive display on a solid wall strong enough to bear its weight.
- ◆ Lay a protective sheet on a table, which was wrapped around the display when it was packaged, beneath the screen surface so as not to scratch the screen face.
- ◆ Ensure you have all accessories for mounting this display (wall mount, ceiling mount, etc).
- ◆ Follow the instructions that come with the base mounting kit. Failure to follow correct mounting procedures could result in damage to the equipment or injury to the user or installer. Product warranty does not cover damage caused by improper installation.

PRODUCT DESCRIPTION

1.4.1 VESA Grid

Model Name	VESA Grid
IFP6504P-AO	600(W) x 400(H)mm
IFP7504P-AO	800(W) x 400(H)mm
IFP8604P-AO	800(W) x 600(H)mm

Caution:

To prevent the display from falling:

- ◆ For wall or ceiling installation, we recommend installing the display with metal brackets which are commercially available. For detailed installation instructions, see the guide received with the respective bracket.
- ◆ To lessen the probability of injury and damage resulting from fall of the display in case of earthquake or other natural disaster, be sure to consult the bracket manufacturer for installation location.

1.4.2 Mounting the Interactive Display on the Wall

To mount the interactive display on the wall, you need the following items:

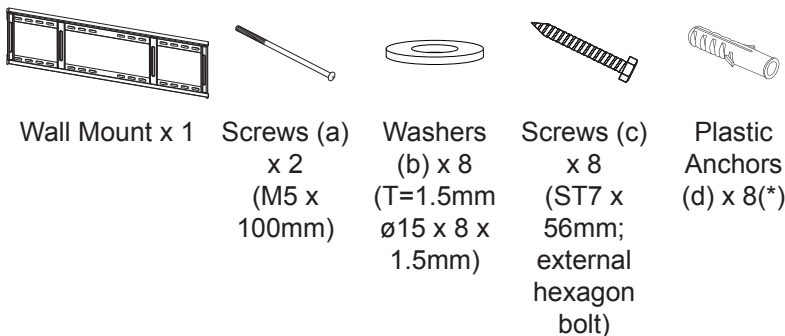

- 1 Mark the eight wall mount screw hole locations on the wall.

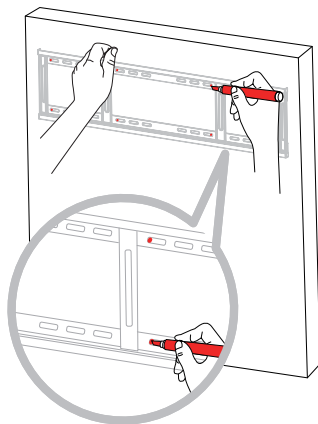

Note:

- ◆ For the wall-mounting kit, use M6 mounting screws (having a length 10 mm longer than the thickness of the mounting bracket) and tighten them securely.
- ◆ Unit without bracket weight:
IFP6504P-AO=40.5 kg /
IFP7504P-AO=50.7 kg /
IFP8604P-AO=68.7 kg.
The equipment and its associated mounting means still remain secure during the test. For use only with UL Listed Wall Mount Bracket with minimum weight/load:
IFP6504P-AO=43.3 kg /
IFP7504P-AO=57.3 kg /
IFP8604P-AO=72.0 kg.
- ◆ (*) The specification of the plastic anchor is as follows:

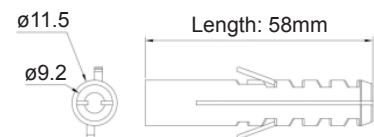

PRODUCT DESCRIPTION

- 2 Drill eight small holes on the mounting location with the length and width 55mm x 10mm respectively.

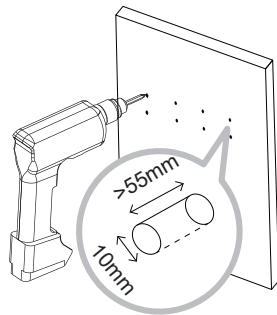

- 3 Insert a plastic anchor (d) into each hole.

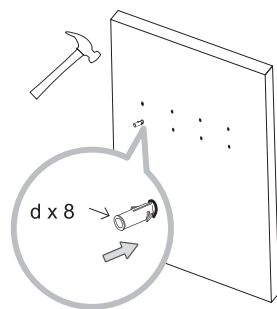

- 4 Secure the wall mount with the eight supplied screws (c) through the washers (b) into the eight installed anchors on the wall.

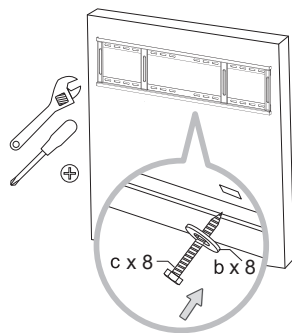

- 5 Align and hook the dual wall mount on the interactive display to the wall mount.

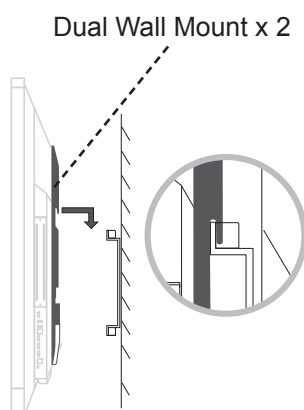

Note:

- ◆ Keep clearances around the interactive display according to the minimum dimensions as illustrated.
- ◆ Never cover the ventilation holes or insert anything into the housing.
- ◆ Do not place the interactive display in a confined space, such as a cabinet or imbedded closet. Place the display on a sturdy, level surface and make sure an appropriate ventilation is provided.

PRODUCT DESCRIPTION

- 6 Secure the dual wall mount and the wall mount with the two screws (a).

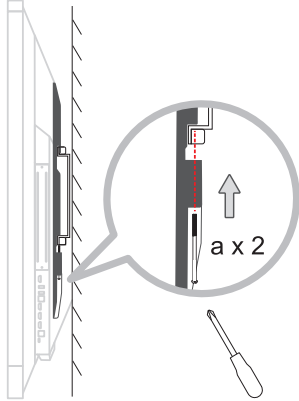

Warning:

Make sure the power cord of the interactive display is disconnected before the installation.

1.4.3 Ventilation Requirements for Enclosure Locating

To allow heat to disperse, leave space between surrounding objects as shown in the diagram below.

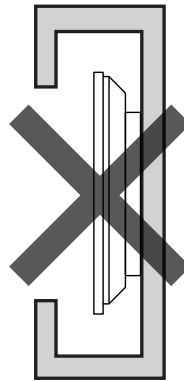
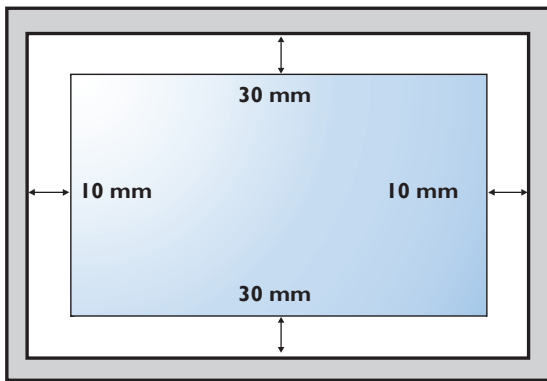

PRODUCT DESCRIPTION

1.5 Mounting the Interactive Display on the Stand

To mount the interactive display on the stand, you need the following items:

Note:

- ◆ Mounting bracket model is FMC-07. (Optional)

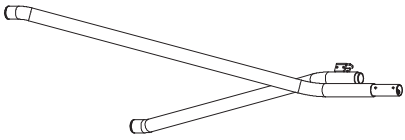

A- Column (L) x 1

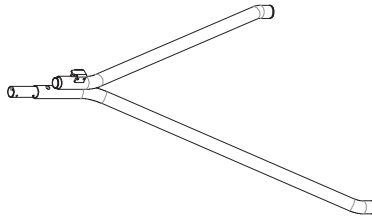

B- Column (R) x 1

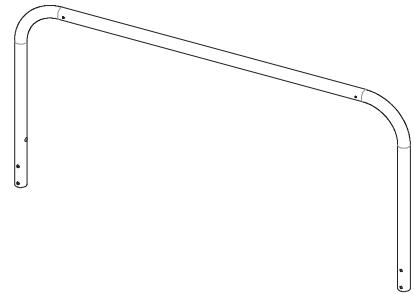

C- Big U Tube x 1

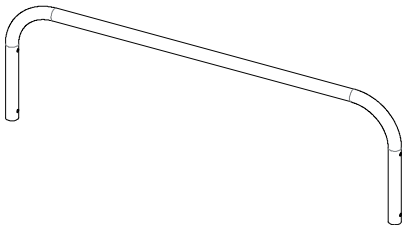

D- Small U Tube x 1

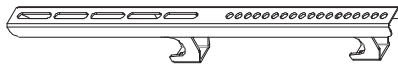

E- Mounting Bracket x 2

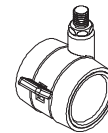

F- Caster x 4
(With Brake)

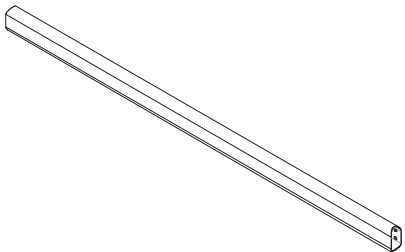

G- Horizontal tube x1



H- Screw (M6 x 12) x 10



J- Screw (M8 x 45) x 4



K- Screw (M8 x 25) x 4

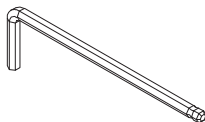

L- Hexagon Wrench (4mm) x 1

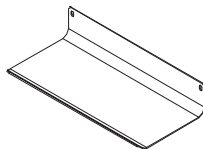

Q- Tray x 1

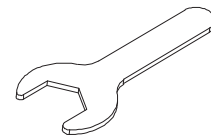

P- Open End Wrench (19mm) x 1

PRODUCT DESCRIPTION

1 Assemble the Horizontal tube between the two columns.

- H: Screw (M6 x 12) x 4

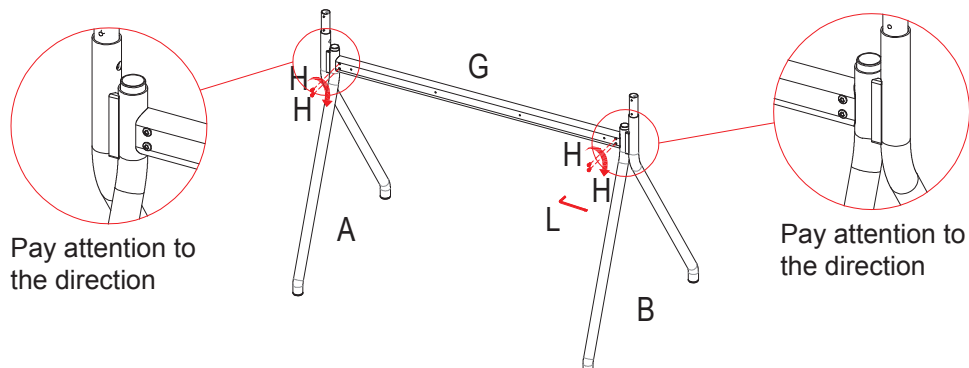

Note:

- ◆ Do not tighten the screws fully until step 4.

2 Assemble the Big U tube between the two columns.

- H: Screw (M6 x 12) x 4

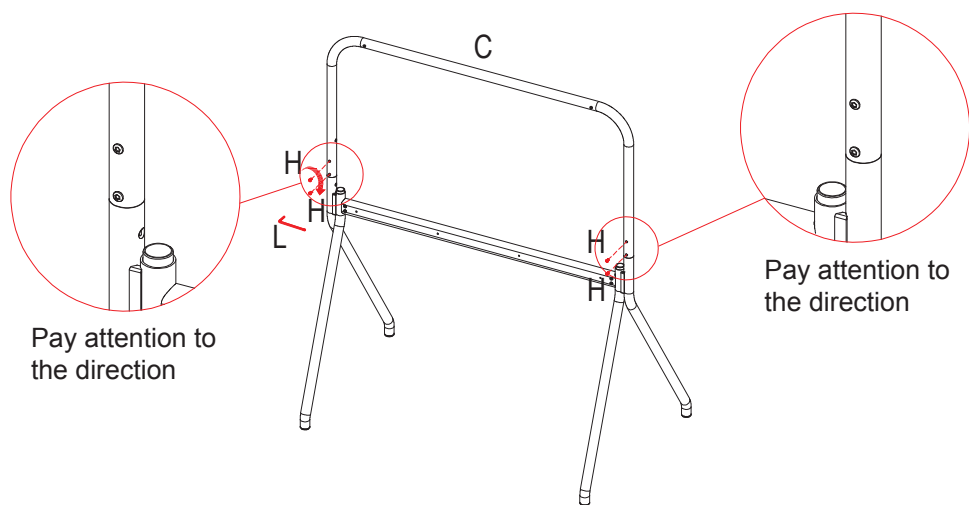

Note:

- ◆ Do not tighten the screws fully until step 4.

PRODUCT DESCRIPTION

- 3 Assemble the Small U tube between the two columns.
- J: Screw (M8 x 45) x 4

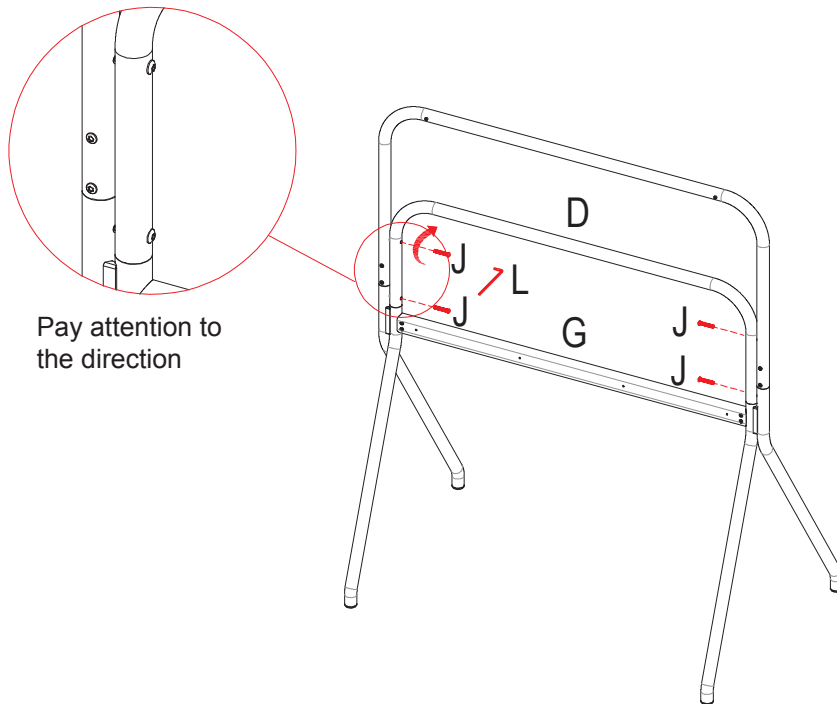

Note:

- ◆ Do not tighten the screws fully until step 4.

- 4 Place the stand on the level ground and ensure that each component is in its right position. Then follow steps "a" to "c" (as marked in the illustration) to secure the screws.

a) Secure all the small U tube fixing screws.

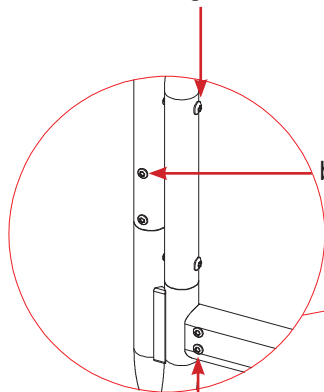

b) Secure all the large U tube fixing screws.

c) Secure all the horizontal tube fixing screws.

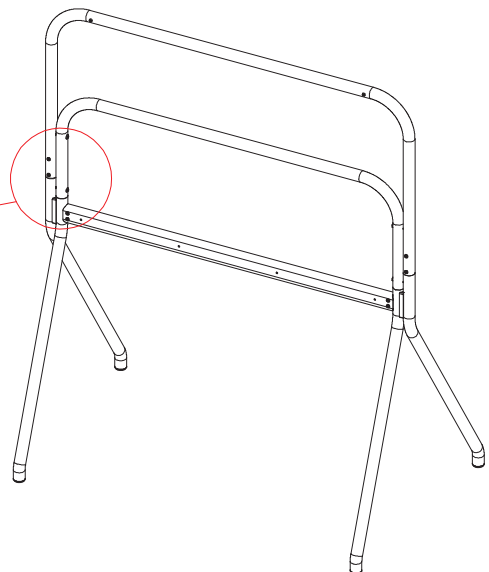

PRODUCT DESCRIPTION

- 5 Place the stand face down on the floor. Adjust the wheel to the brake state and rotate it into the leg. Repeat the step for the remaining wheels.

When turning the wheel, adjust the wheel to the brake state in advance

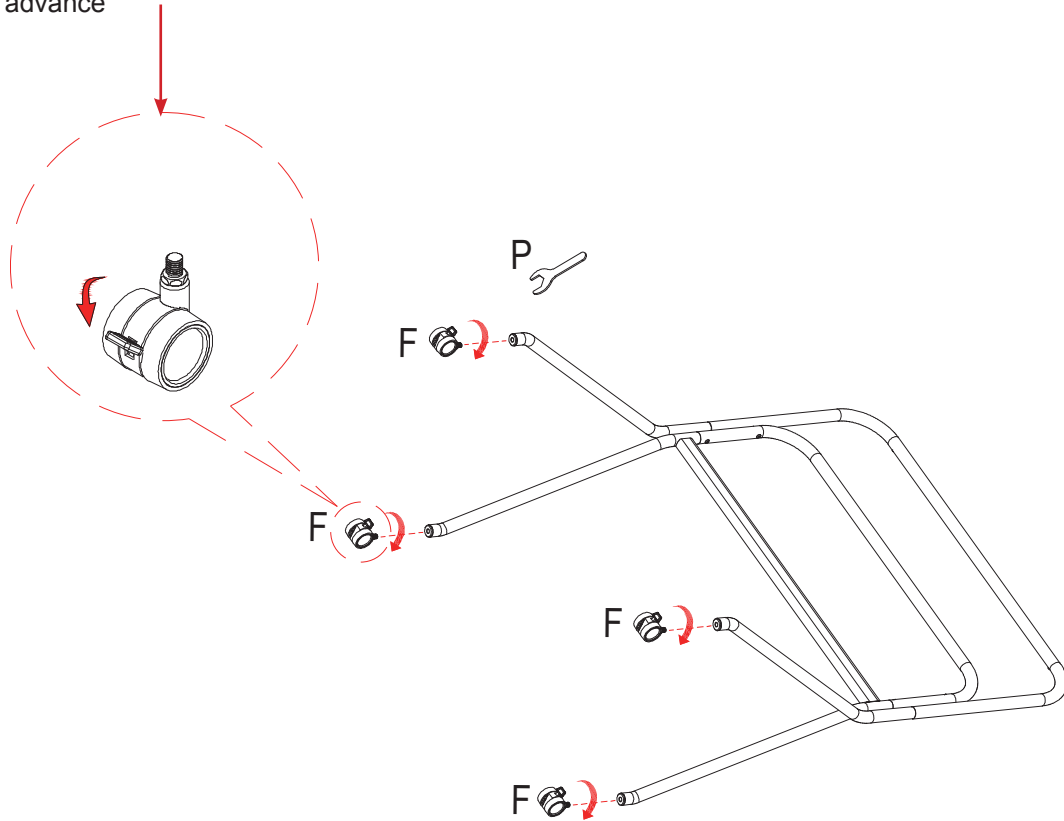

- 6 Align and secure the mounting brackets on both sides of the interactive display. Secure the mounting brackets to the display with the provided screws.

- **K:** Screw (M8 x 25) x 4

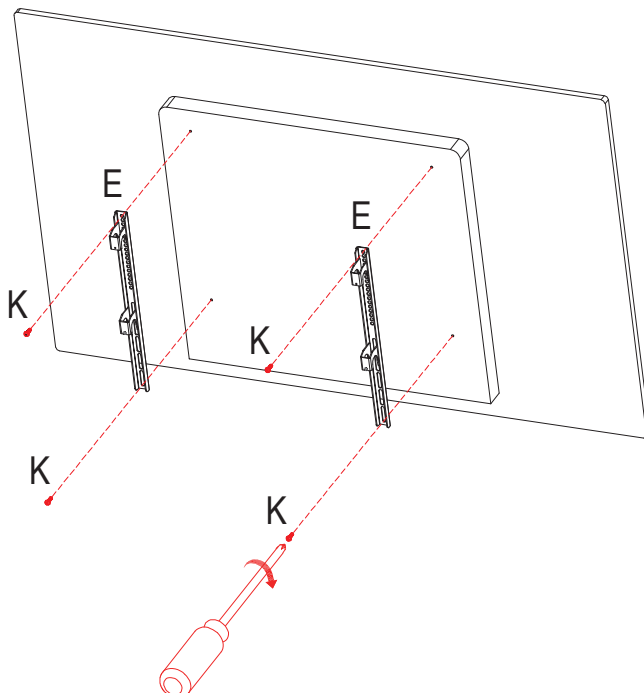

PRODUCT DESCRIPTION

- 7 Place the stand upright. Then hang the interactive display assembly to the stand and lock it in place with the safety screw.
- **Safety screw:** Captive screw that is pre-attached to the mounting bracket.

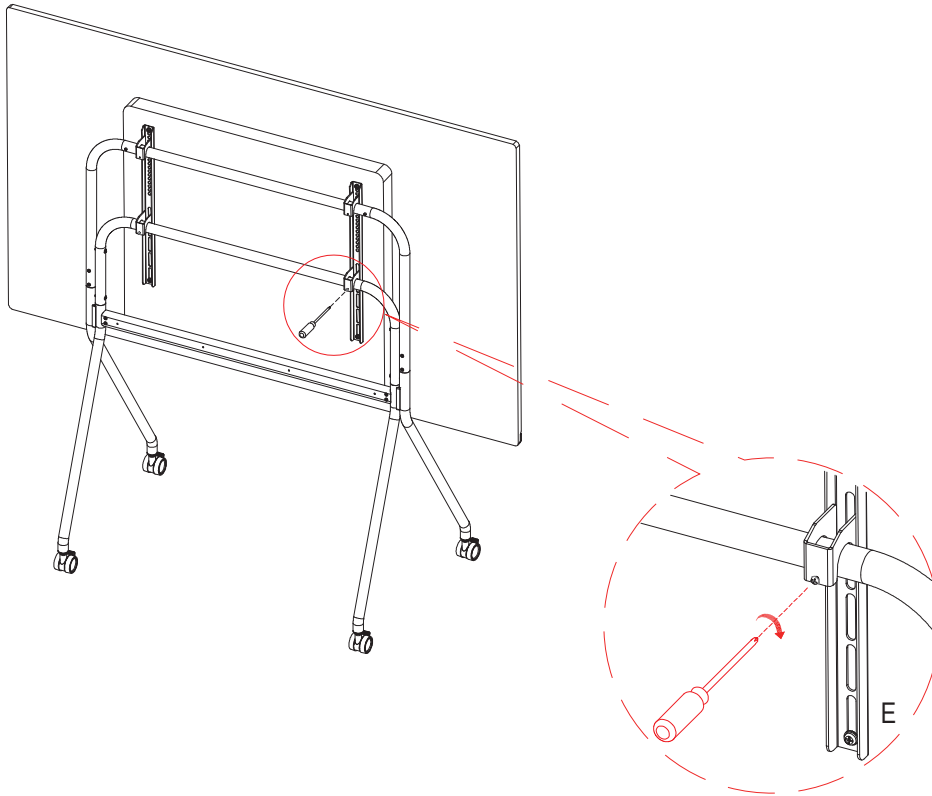

Mounting the interactive display on the stand is complete.

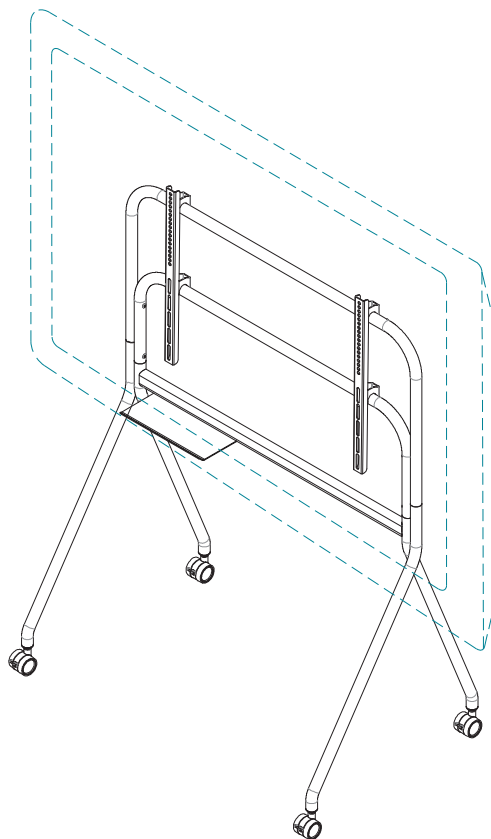

PRODUCT DESCRIPTION

Note:

- ◆ You can install an optional tray to the stand. The position of the tray is adjustable.
 - **H:** Screw (M6 x 12) x 2

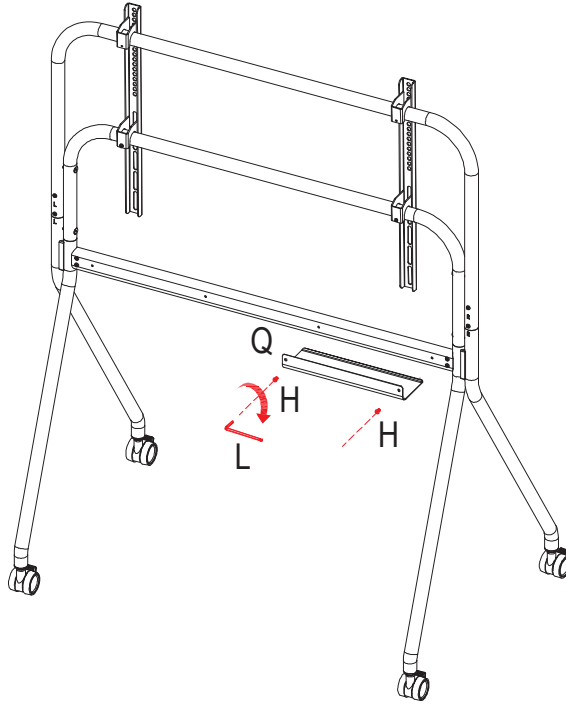

1.6 Installing the Wi-Fi Module

To use wireless connectivity, you need to install the Wi-Fi module to the interactive display.

- 1 Remove the two screws from the Wi-Fi module slot cover.

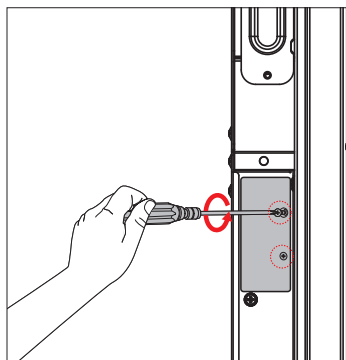

PRODUCT DESCRIPTION

- 2 Remove the Wi-Fi module slot cover.

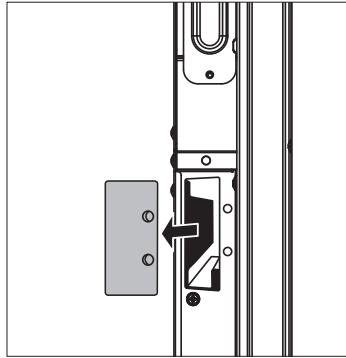

- 3 Insert the Wi-Fi module into its slot in the interactive display and secure it in place with the Wi-Fi module slot cover screws.

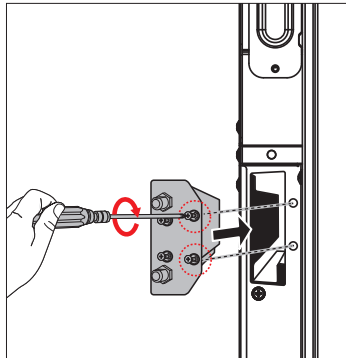

- 4 Firmly tighten antennas to the Wi-Fi module connectors.

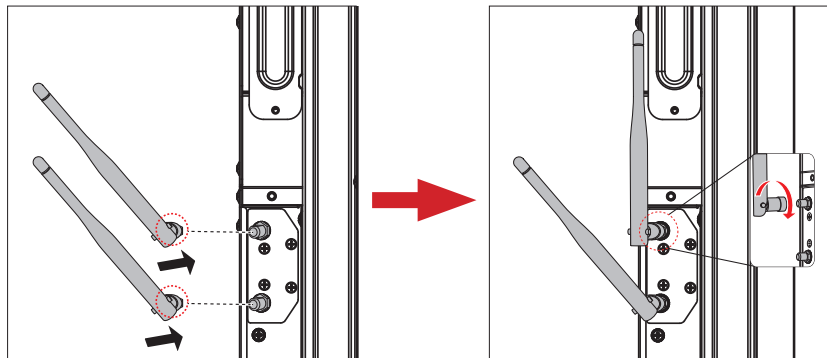

PRODUCT DESCRIPTION

1.7 Inserting an OPS Module

Insert the OPS module into the OPS slot on the rear of the interactive display. Secure the OPS module to the interactive display with the screws.

Note:

- ◆ Ensure that the OPS module size is 180 x 119 x 30 mm and the power rating is 18V; 5A.

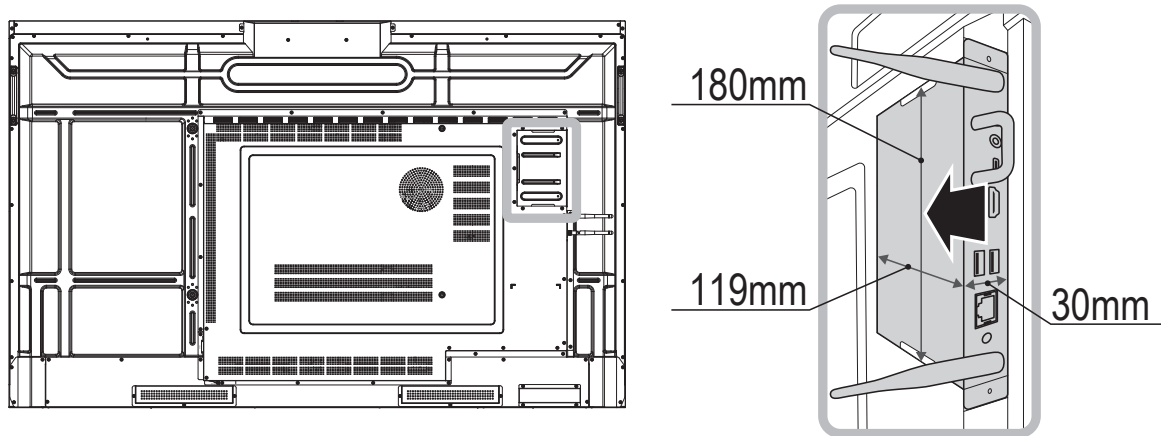

1.8 Using the Active Pen

Use the active pen to write and draw smoothly on the interactive display.

1.8.1 Button Functions and LED Light

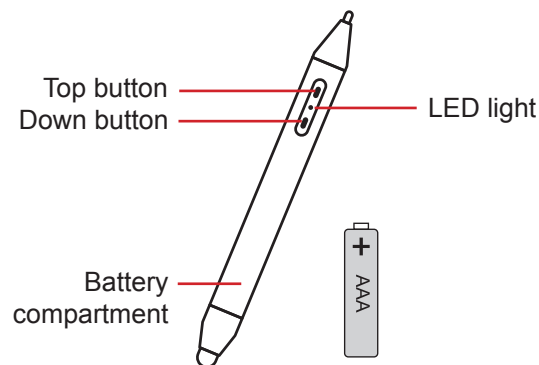

Item	Action	Function	Remark
Top button	Click	Page up	
	Press	Press and hold for more than 4 seconds to enter the sleep mode. (*)	If the active pen is in sleep mode, then the LED lights turns solid on.
		Open PPT and long press for 1.5 to 4 seconds to display PPT in full screen.	
Down button	Click	Page down	
	Press	Press and hold for more than 4 seconds to enter the pairing mode.	
		Open PPT and long press for 1.5 to 4 seconds to display PPT in full screen.	

PRODUCT DESCRIPTION

Item	Action	Function	Remark
LED light	Flashing green (1 second on/ 1 second off)	Enter the pairing mode	
	Flashing green (4 times a second)	Enter the pairing mode	

Note: (*)

- ◆ The active pen enters the sleep mode after 5 minutes of inactivity. To wake the pen, press the pen buttons or start writing/drawing on the screen.
- ◆ To enter the sleep mode manually, press the Top button for more than 4 seconds.

1.8.2 Installing the Battery

Remove the battery compartment cover and install one AAA battery into the pen. Then replace the battery compartment cover.

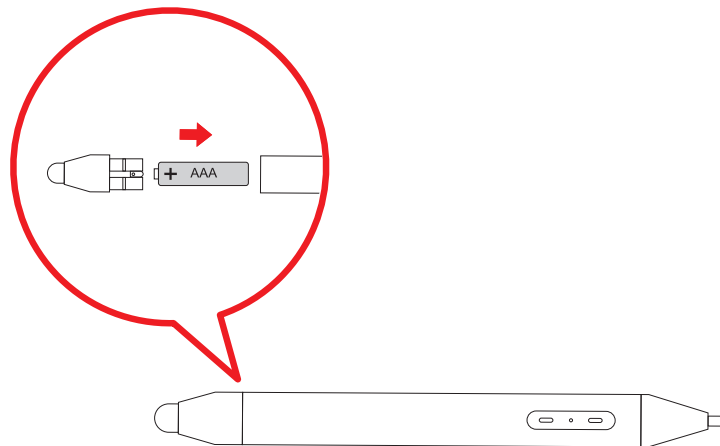

PRODUCT DESCRIPTION

1.8.3 Pairing with the Active Pen

To pair the active pen with the interactive display, do the following:

- 1 Press the Down button on the active pen for more than 4 seconds. When the LED light starts flashing green, then the pen is in pairing mode.
- 2 Touch **All apps** > **Settings** > **Device Management** > **Active pen**.
- 3 Touch **CLICK PAIRING**.

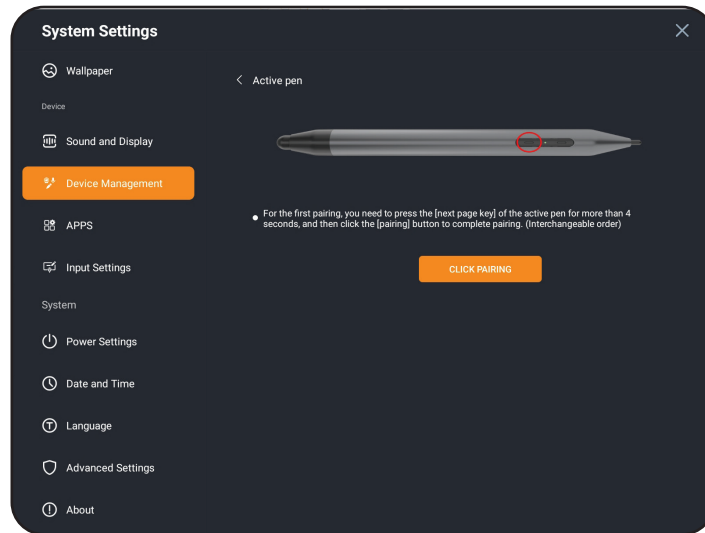

When pairing is complete, the “Active pen connection succeeded” pop-up appears on the bottom of the screen.

1.9 Placing the Stylus & Active Pen

While not using the stylus or/and active pen, attach them to the magnetic areas on the interactive display's front panel.

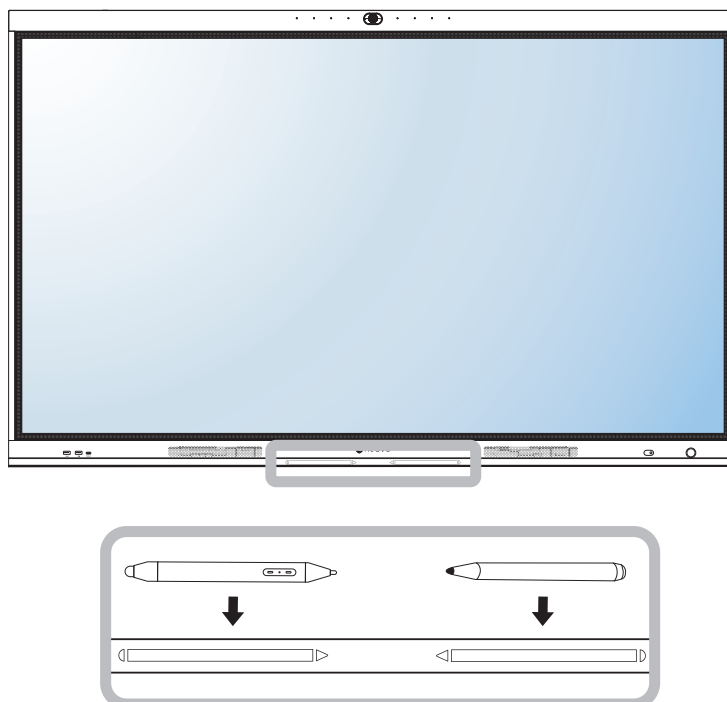

PRODUCT DESCRIPTION

1.10 Interactive Display Overview

1.10.1 Front Panel

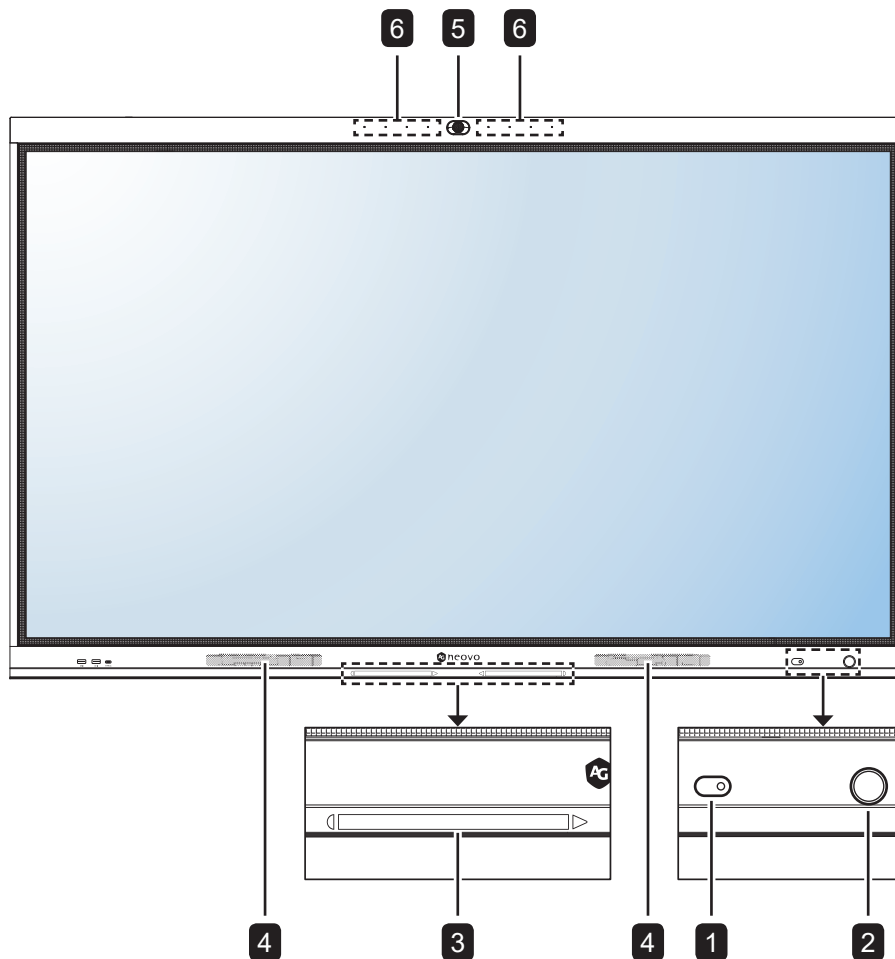

1 Remote control sensor & ambient light sensor

- Remote control sensor: Receives command signals from the remote control.
- Ambient light sensor: With the built-in ambient light sensor, user can enable the Adaptive brightness feature to automatically adjust the LCD screen brightness according to the ambient light. This feature comforts the eyes and helps optimize energy efficiently.

Note: Please make sure the ambient light sensor is not covered when enabling this function.

2 POWER button with LED indicator

- Short press (<3 seconds) to turn the display on or off without shutting down the system.
 - Long press (>3 seconds) to shut down the system.
- LED indicator:
- Blue: The system is turned on.
 - Red: The system is in standby mode.

3 Stylus or active pen emplacements

Magnetic areas for attaching touch pens.

4 Speakers

Internal speakers for audio output.

5 Camera

For video communication.

6 Microphones

For sound input.

PRODUCT DESCRIPTION

1.10.2 Input/Output Terminals

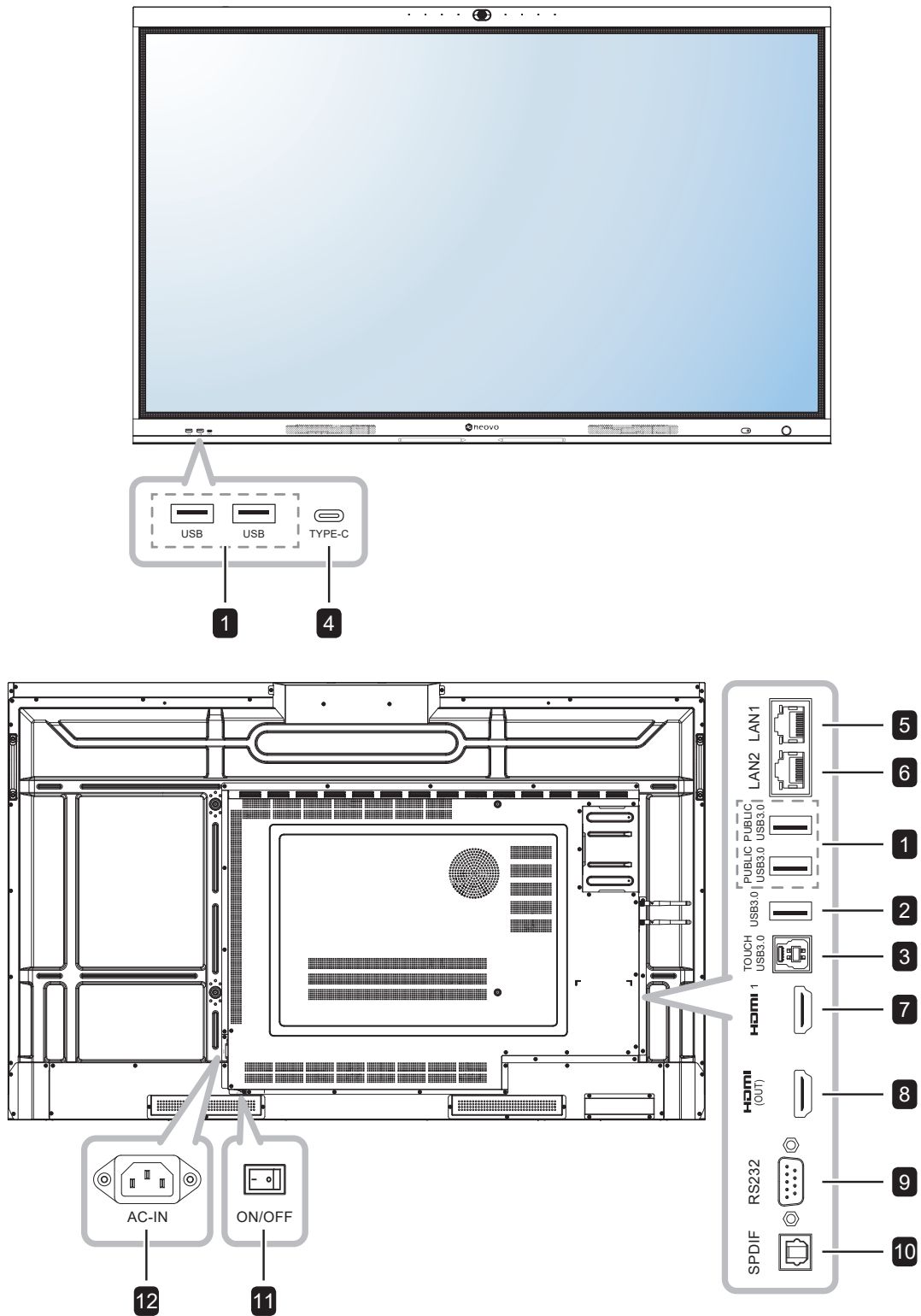

PRODUCT DESCRIPTION

- 1 USB/PUBLIC USB3.0**
Connects to a USB interface device.
- 2 USB3.0**
Connects to a USB interface device.
- 3 TOUCH USB3.0**
Connects USB for touch screen control.
- 4 TYPE-C**
Connects to a USB interface device.
- 5 LAN1**
For internet connection with an Ethernet cable.
- 6 LAN2**
For internet connection with an Ethernet cable.
- 7 HDMI 1**
Connects HDMI signals input.
- 8 HDMI (OUT)**
Connects HDMI signals output.
- 9 RS232**
Connects RS232 input from external equipment.
- 10 SPDIF**
Connects digital audio signals output.
- 11 ON/OFF**
Switches the main power on/off.
- 12 AC-IN**
AC power input.

PRODUCT DESCRIPTION

1.11 Remote Control

1.11.1 General Functions

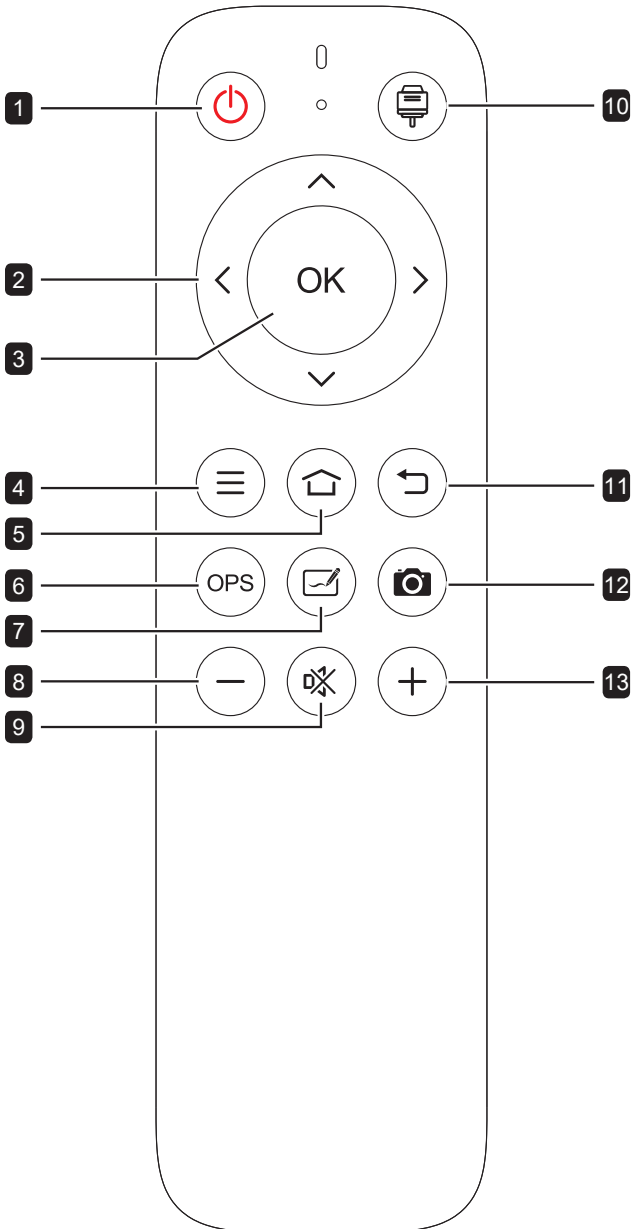

- 1 [Power icon] Power button**
Turns the system on or shuts down.
- 2 [Left][Right][Up][Down] Navigation buttons**
Adjusts the settings.
- 3 [OK] Enter button**
Confirms your selection or saves the modifications.
- 4 [Menu icon] Menu button**
Opens the System Settings menu.
- 5 [Home icon] Home button**
Returns to the Home screen (Android OS).
- 6 [OPS] OPS button**
Switches to the on-board OPS module.
- 7 [Envelope icon] Meetboard app button**
Switches the system into **Meetboard** app (Android OS).
- 8 [Minus] Volume down button**
Decreases audio volume.
- 9 [Mute icon] Mute button**
Turns the mute function on or off.
- 10 [Speaker icon] Source button**
Opens the Source menu.
- 11 [Left arrow] Back button**
Returns to the previous screen (Android OS).
- 12 [Camera icon] Screenshot button**
Captures a screenshot.
- 13 [Plus] Volume up button**
Increases audio volume.

PRODUCT DESCRIPTION

1.11.2 Inserting the Batteries in the Remote Control

The remote control is powered by two 1.5V AAA batteries.

To install or replace batteries:

- 1 Unlatch and then remove the battery compartment cover.
- 2 Align the batteries according to the (+) and (-) indications inside the battery compartment.
- 3 Replace the battery compartment cover.

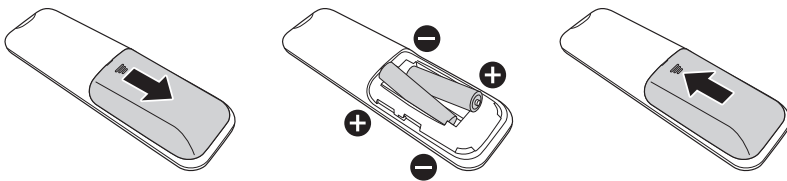

1.11.3 Handling the Remote Control

- Do not subject to strong shock.
- Do not allow water or other liquid to splash the remote control. If the remote control gets wet, wipe it dry immediately.
- Avoid exposure to heat and steam.
- Other than to install the batteries, do not open the remote control.

Caution:

The incorrect use of batteries can result in leaks or bursting. Be sure to follow these instructions:

- ◆ Place “AAA” batteries matching the (+) and (-) signs on each battery to the (+) and (-) signs of the battery compartment.
- ◆ Do not mix battery types.
- ◆ Do not combine new batteries with used ones. It causes shorter life or leakage of batteries.
- ◆ Remove the dead batteries immediately to prevent them from liquid leaking in the battery compartment. Don't touch exposed battery acid, as it can damage your skin.

Note:

- ◆ If you do not intend to use the remote control for a long period, remove the batteries.
- ◆ The remote control may not function properly when the remote control sensor on this display is under direct sunlight or strong illumination, or when there is an obstacle in the path of signal transmission.

PRODUCT DESCRIPTION

1.11.4 Operating Range of the Remote Control

Point the top of the remote control toward the display's remote control sensor (on the right side) when pressing a button.

When using the remote control, the distance from the remote control to the sensor on the display should be less than 7m/22.96ft, and the horizontal and vertical angles should be less than 30°.

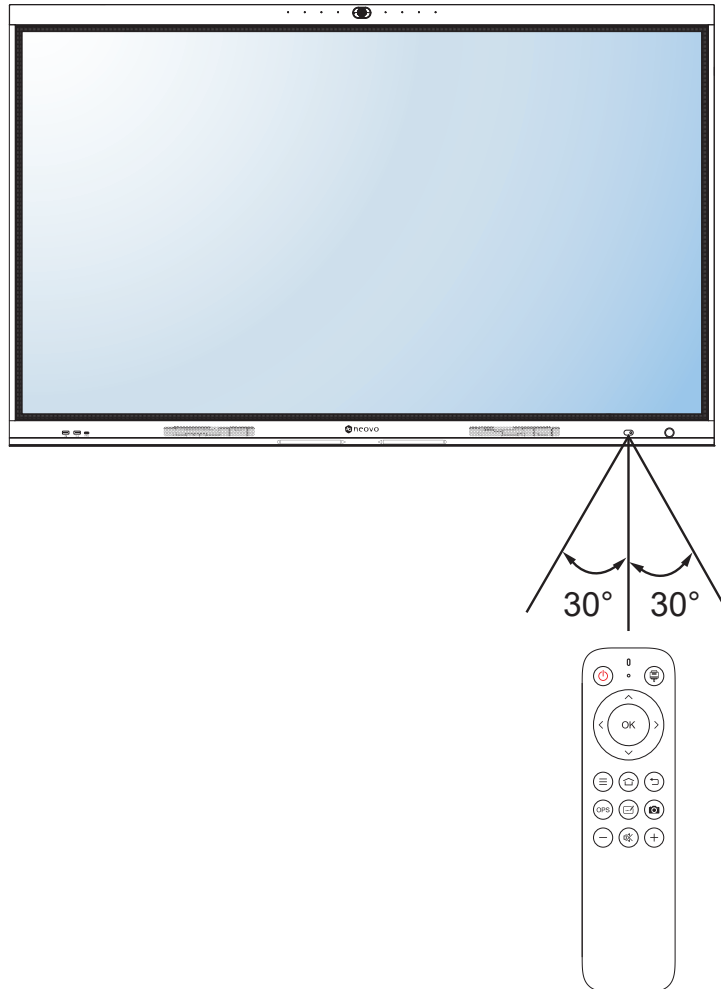

CHAPTER 2: MAKING CONNECTIONS

2.1 Connection Diagram

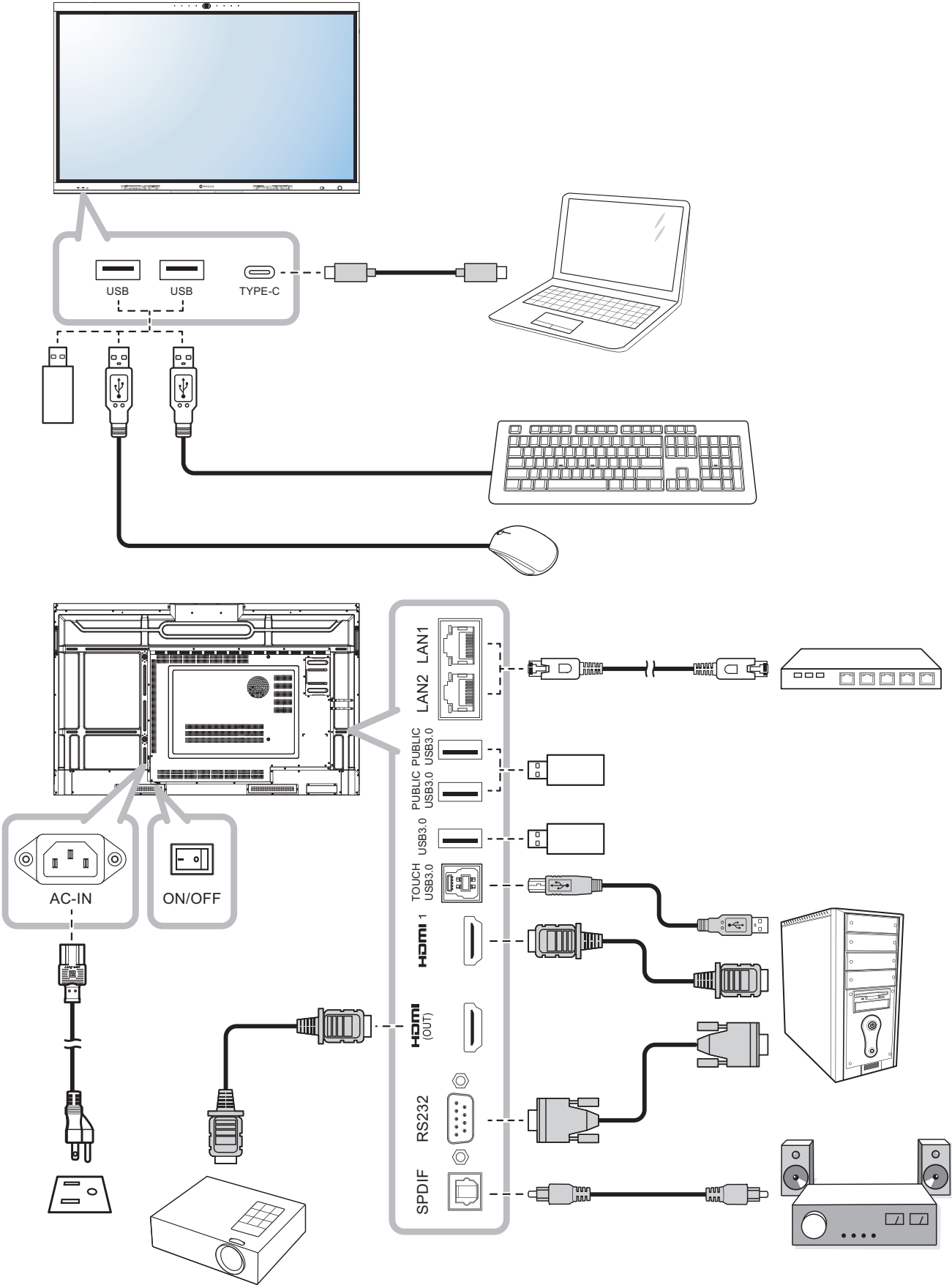



CHAPTER 3: USING THE INTERACTIVE DISPLAY

3.1 Using the Touchscreen

In addition to the remote control, you can also operate your interactive display using the touch gestures as described in the tables below.

For Android

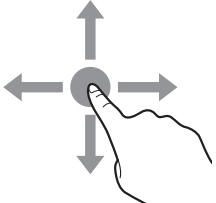
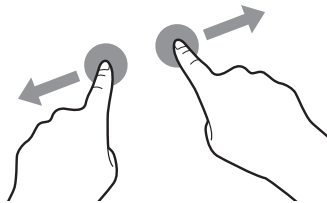
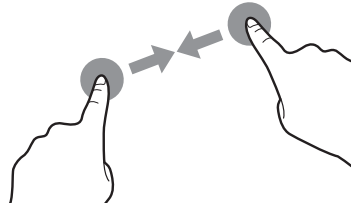
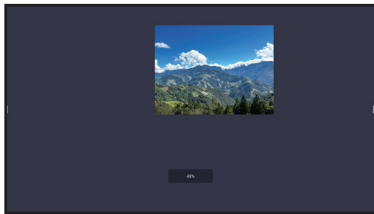
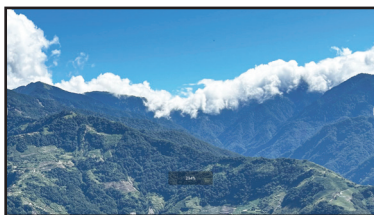

Action	Touch Gesture	Function
Touch		<p>Touch to open clickable items on the screen, such as apps, Sidebar menu options, and more.</p> <p>Note:</p> <ul style="list-style-type: none"> ◆ Always touch the screen with your finger or with the supplied touch pen. ◆ Do not touch the screen with sharp, metallic objects that could scratch the screen's coating.
Touch and hold		<ul style="list-style-type: none"> • Uninstall apps on the Apps screen. • Adjust settings by dragging the slider up, down, left, or right.
Drag or swipe		
Zoom	<p>Zoom in</p>  <p>Zoom out</p> 	<ul style="list-style-type: none"> • Zoom in and zoom out on the image. <p>For example:</p> <div style="text-align: center;"> <p>Zoom in</p>  <p>Zoom out</p>  </div>

USING THE INTERACTIVE DISPLAY

For Windows

Note:

- ◆ Make sure you have connected properly the Windows-based device to the interactive display.
- ◆ Multi-touch functions are only supported on Windows 11, Windows 10, Windows 8, Windows 7 Home Premium /Professional / Enterprise / Ultimate operating systems and not supported on Windows XP, Windows Vista, and Windows 7 Starter / Home Basic.
- ◆ Windows is a registered trademark of Microsoft Corporation in the United States and other countries.

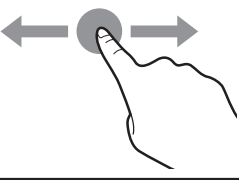
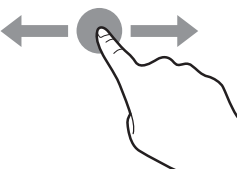
Function	Touch Gesture	Action
Single-touch gestures:		
Note:		
◆ For Windows XP, Windows Vista, Windows 7, Windows 8, Windows 10, and Windows 11.		
Tap		Touch the screen once.
Double-tap		Touch the screen twice.
Right-tap		Touch and hold on the target until a blue ring appears. Then release your finger.
Drag		Touch the screen and drag with one finger to the left or to the right.
Note:		
◆ For Windows Vista, Windows 7, Windows 8, Windows 10, and Windows 11.		
Selection		Touch the screen and drag with one finger to the left or to the right.

USING THE INTERACTIVE DISPLAY

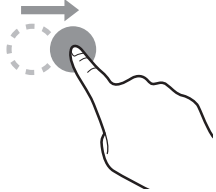
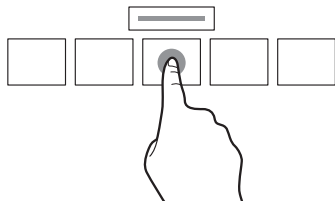
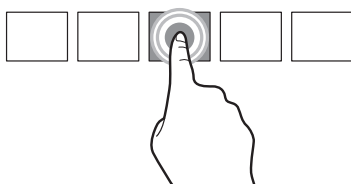
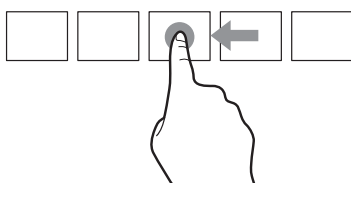
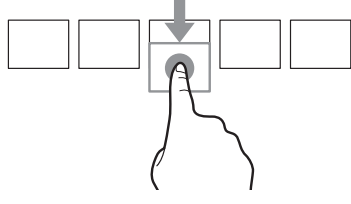
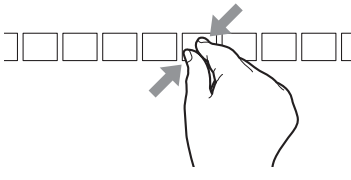
Function	Touch Gesture	Action
Pan up / Pan down / Back / Forward		Touch the screen and quickly drag your finger to the desired direction.
Note:		
♦ For Windows 8		
Learn		Touch and hold the screen to display more information. Anything displayed this way should not prevent you panning.
Primary action		Touch the target to invoke its primary action. For example, launch an app or execute a command.
Pan		Touch the screen and slide for panning interactions, moving items, drawing, or for writing. Slide can also be used to target small, densely packed elements by scrubbing (sliding the finger over related objects, such as radio buttons).
Select, command, and move		Touch the screen and swipe to select, command, and move. Sliding your finger a short distance, perpendicular to the panning direction, selects objects in a list or grid and displays the app bar with related commands when objects are selected.
Zoom		Touch the screen and pinch or stretch to zoom out or zoom in respectively. The pinch and stretch gestures are more commonly used for resizing but also enable to move to the beginning, end, or anywhere within content with semantic zoom.
Note:		
♦ For Windows XP, Windows Vista, and Windows 7		

USING THE INTERACTIVE DISPLAY

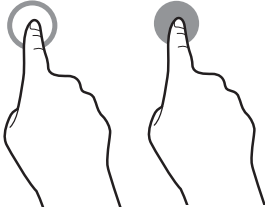
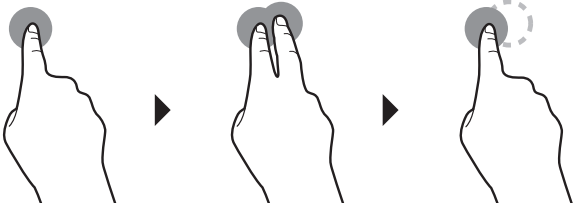
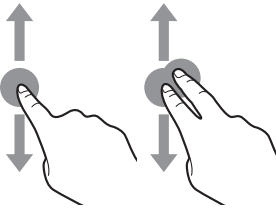
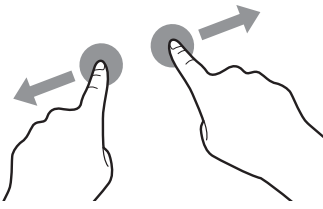
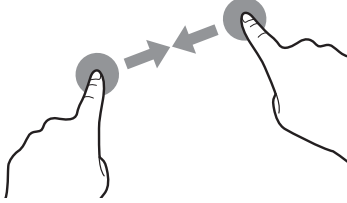
Function	Touch Gesture	Action
Wake the computer up from the standby mode (S3)		Touch and hold the screen for around 4 seconds.
Multi-touch gestures:		
Note:		
◆ For Windows 7 Home Premium / Professional / Enterprise / Ultimate version		
Right-tap		Touch and hold on the target and quickly touch the screen once with another finger.
Scrolling		Touch and drag the screen with one or two fingers up or down.
Zoom	<p style="text-align: center;">Zoom in</p>  <p style="text-align: center;">Zoom out</p> 	Touch the target and move your two fingers apart or toward each other to zoom in or zoom out respectively.

USING THE INTERACTIVE DISPLAY

3.2 Using the On-Screen Keyboard

Whenever you need to input text, an on-screen keyboard opens automatically. Touch the keys on the screen as you would press the keys on a connected keyboard. You can also relocate the on-screen keyboard by holding and dragging the keyboard by the upper edge where is the  icon. To close the on-screen keyboard, press anywhere on the screen outside the keyboard window.

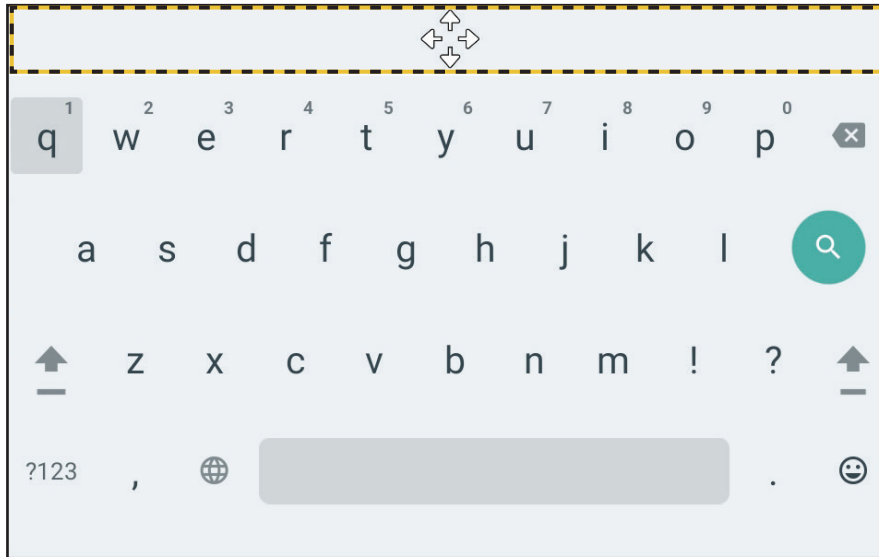

3.3 Initial Setup

After you turn on the interactive display, you are prompted to select the default system language, configure network settings, and more. Follow the on-screen instructions to complete the initial setup.

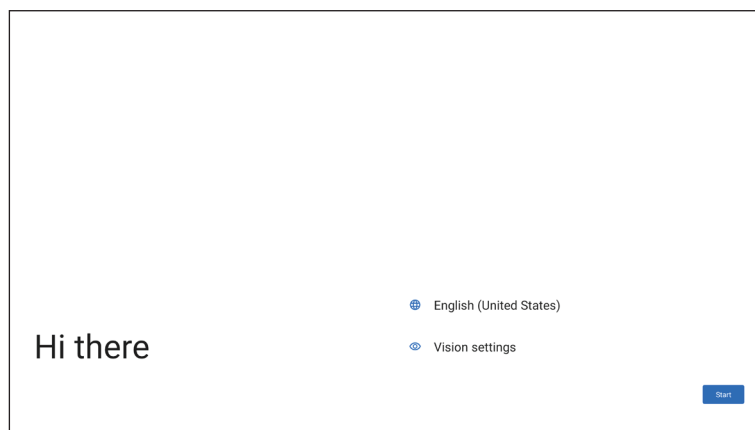

Note:

- ◆ The initial setup screen is prompted only the first time you use the interactive display or after resetting the system.

USING THE INTERACTIVE DISPLAY

After the initial setup, you are prompted instructions on how to unhide the Sidebar menu and how to switch to the standard home page. Read the instructions and touch **Okay, i got it** to dismiss the prompt.

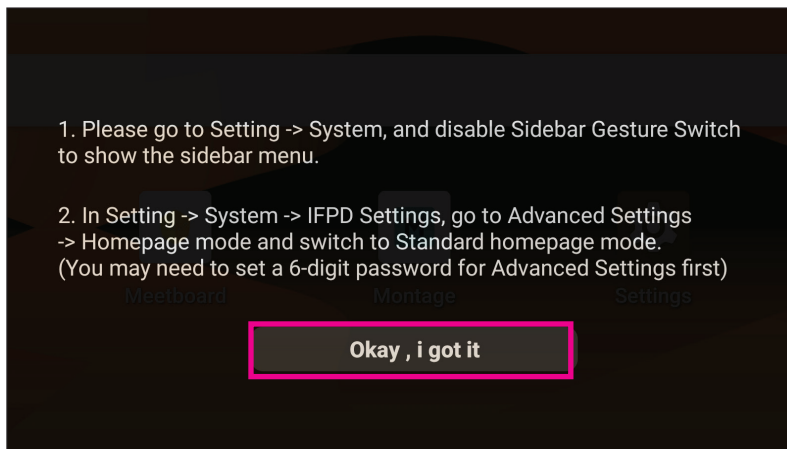

3.3.1 Unhiding the Sidebar

By default, the Sidebar is hidden and you need to swipe inwards from the left or right side of the screen to make it visible. To unhide the Sidebar and keep it visible all the time, do the following:

- 1 Touch **Settings**  on the Home screen.

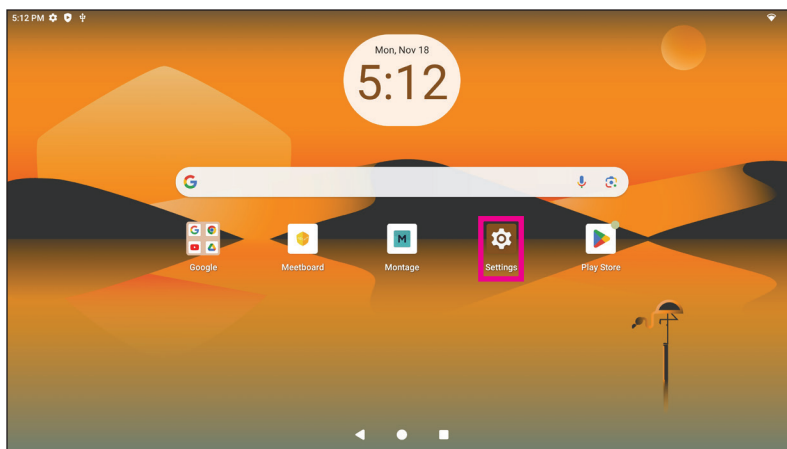

- 2 In the Settings menu, touch **System**. Then disable the Sidebar Gesture Switch.

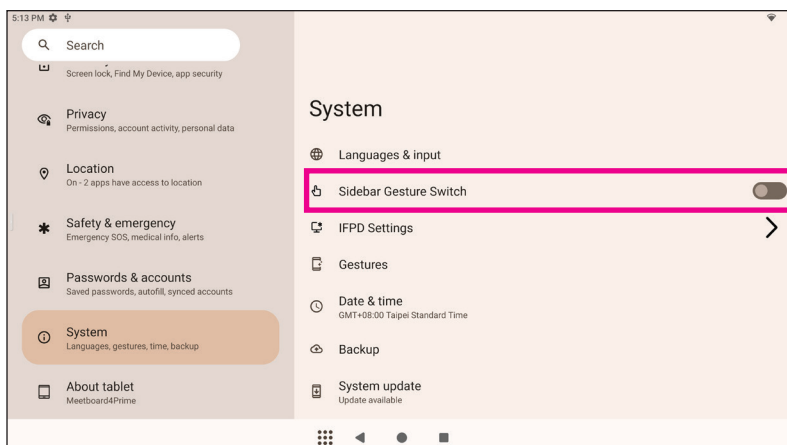

USING THE INTERACTIVE DISPLAY

3.3.2 Switching to the Standard Home Screen

After the initial setup, you will see the EDLA Home screen. To switch to the standard Home screen, do the following:

- 1 Touch **Settings**  on the Home screen.

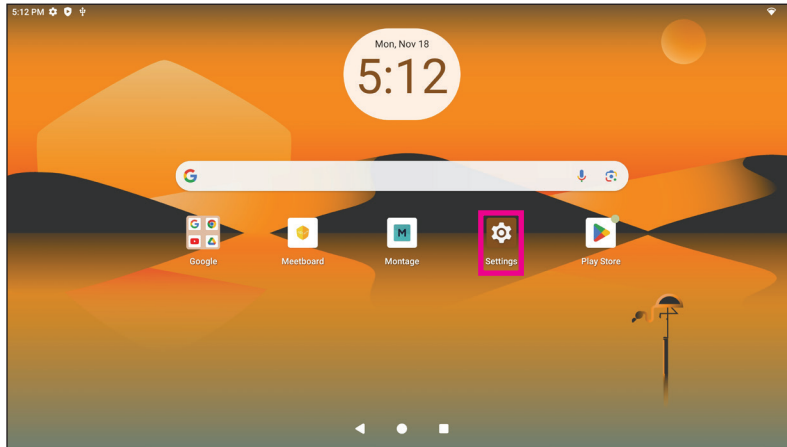

- 2 In the Settings menu, touch **IFPD Settings**.

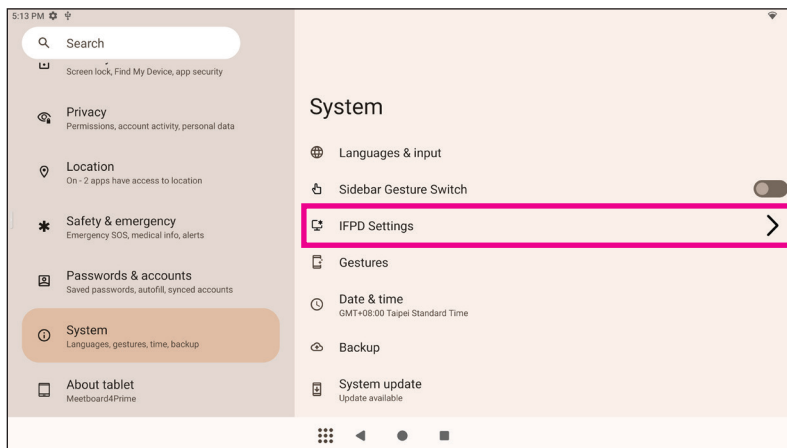

- 3 In the IFPD Settings menu, touch **Advanced Settings**.

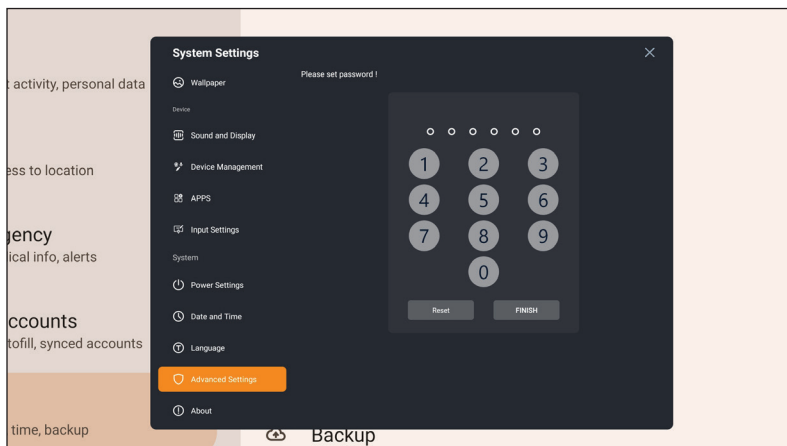

USING THE INTERACTIVE DISPLAY

- 4 Create a 6-digit password and touch **FINISH**.

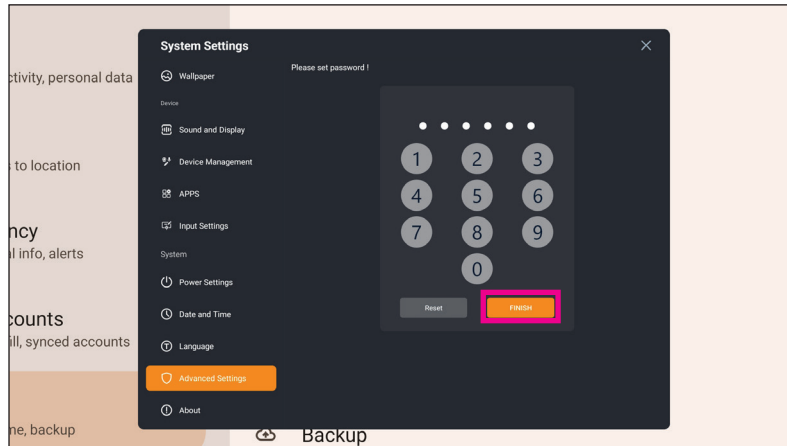

- 5 In the Advanced Settings menu, touch **HomePage mode**.

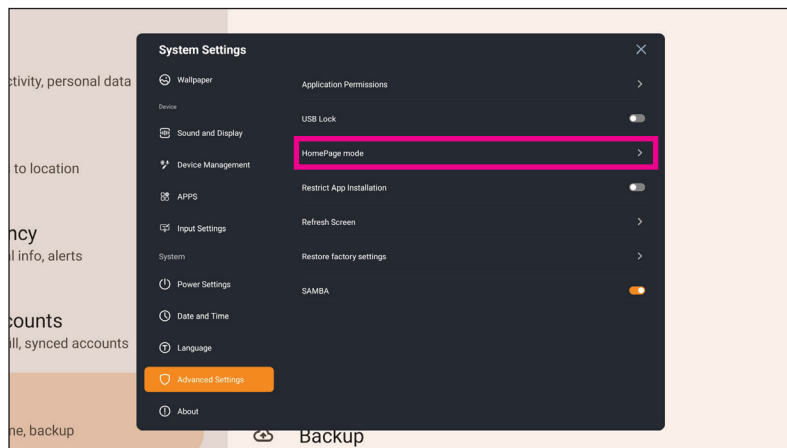

- 6 Set the HomePage mode to **Standard**. The Home screen layout will change immediately.

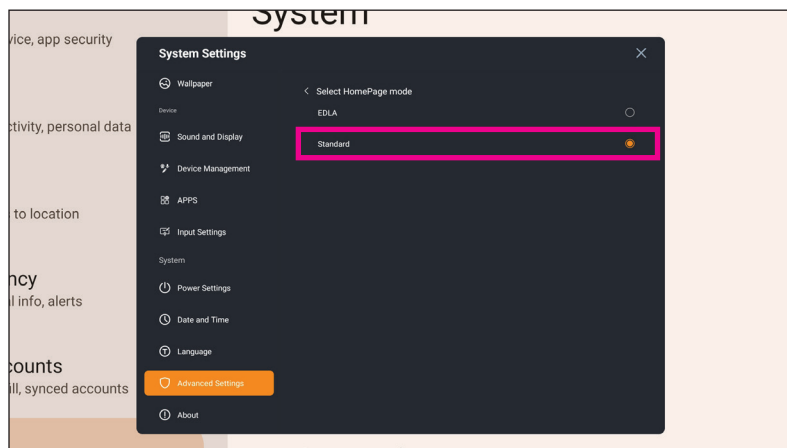

USING THE INTERACTIVE DISPLAY

EDLA Mode

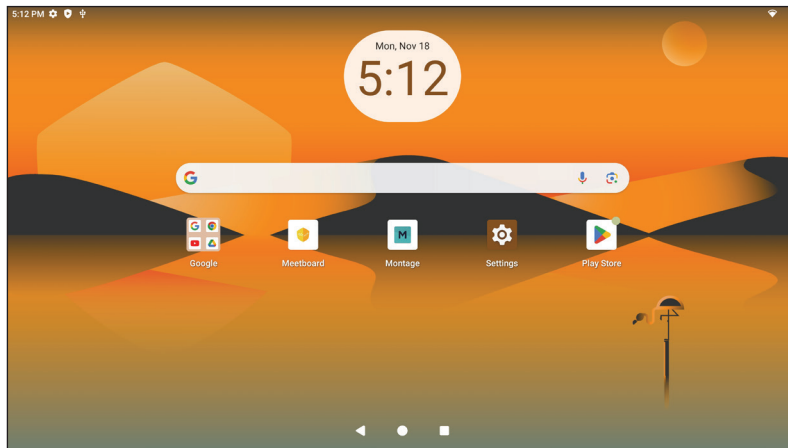

Standard Mode

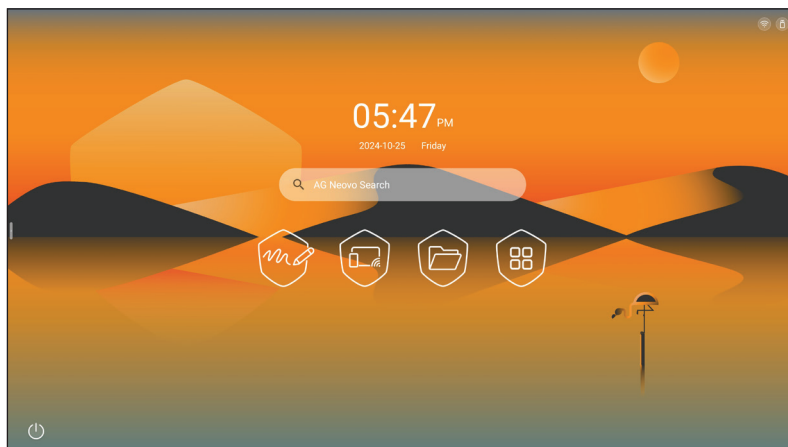

CHAPTER 4: USING THE SYSTEM

4.1 About the Home Screen

After you power on the system, you will see the Home screen. On the Home screen, you can view the current date and time, access the Sidebar menu and various apps.

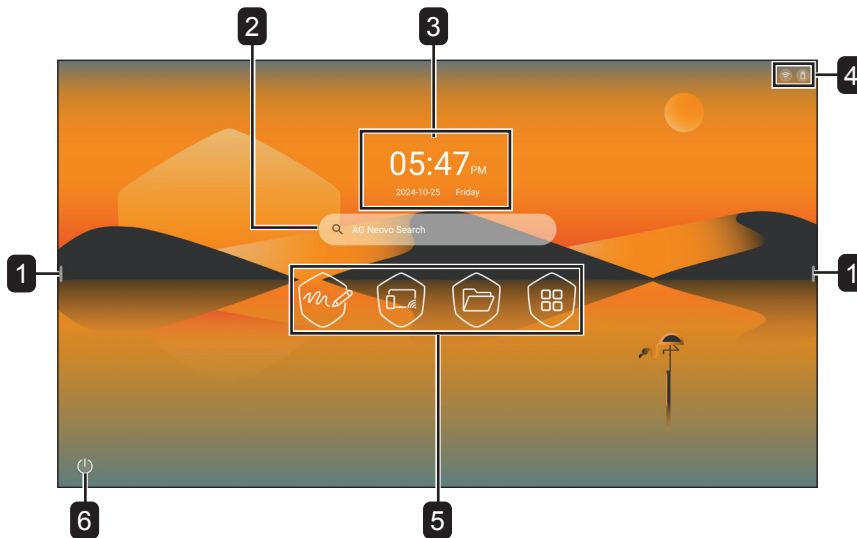

#	Item	Description
1	Sidebar menu	Quick access for apps, Home screen, move backwards, annotation tool, smart hide menu, ScreenShot , Source menu, Floating menu, volume & screen brightness adjustment, and recent tasks. Note: ◆ The Sidebar menu icons  are visible on both sides of the interactive display.
2	AG Neovo Search	Search from the internet.
3	Date and time	Current date and time. Adjust the date and time in the Settings menu.
4	Status bar	Active connections, for example Wi-Fi and USB flash disk.
5	App shortcuts	Access the Meetboard app, Montage app, File Manager app, and Apps screen.
6	Power menu	Touch to turn off the interactive display.

Note:

- ◆ To unlock the interactive display, swipe the unlock icon  upwards.



- ◆ To open the Source menu, swipe upwards from the bottom of the screen.

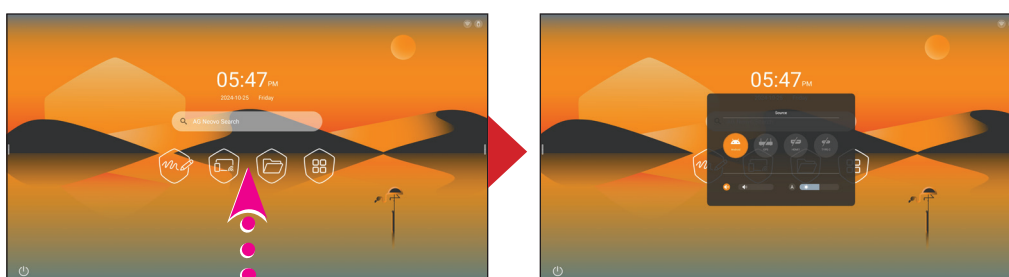

USING THE SYSTEM

4.2 Using the Sidebar menu

The Sidebar menu can be accessed on either sides of the interactive display by touching . Sidebar menu icons are always visible on the screen regardless of your location in the user interface.

Note:

- ◆ If the Sidebar menu icons are not visible on the screen, then swipe inwards from the left or right edge of the screen to display them.

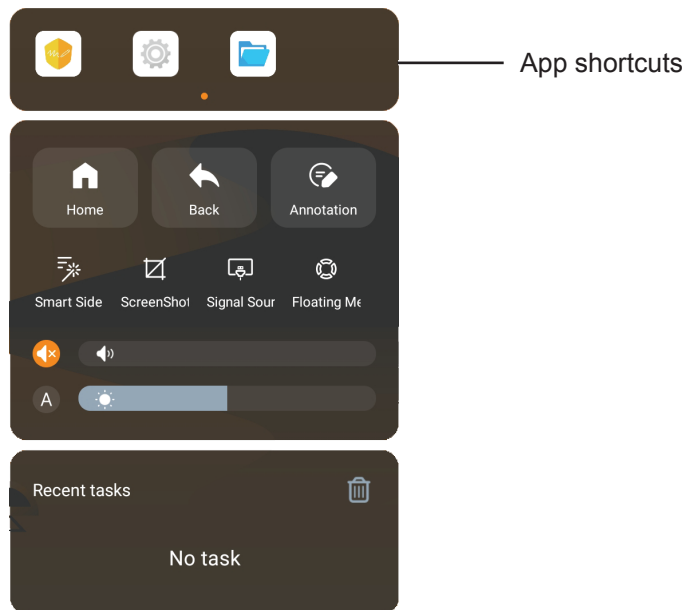

Access any of the following Sidebar menu items based on your needs:

- Touch the app you want to open in the shortcuts menu. To customize app shortcuts, long touch any of the app icons. Then select up to five apps at the prompt that you want to see in the shortcuts menu in addition to the default apps. Touch **Apply** to save the modifications or **Cancel** to discard the modifications.

Note:

- ◆ The default app shortcuts cannot be removed or replaced.

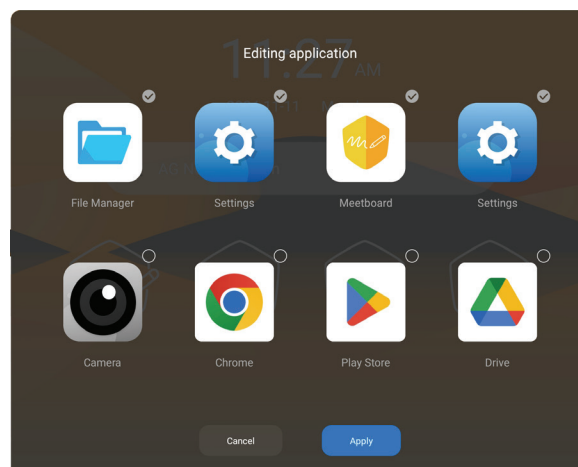

- Touch **Home** to access the Home screen from any other screen or menu.
- Touch **Back** to return to the previous menu or close the app.
- Touch **Annotation** to enter the writing mode. For more information, refer to “5.5 Annotation” on page 60.
- Touch **Smart Sidebar menu** to hide or display the Sidebar menu.

USING THE SYSTEM

- Touch **ScreenShot** to capture the screen image. For more information, refer to “5.6 ScreenShot” on page 61.
- Touch **Signal Source** to select an input source.
- Touch **Floating** to display the Floating menu on the screen.

Note:

- ◆ You can also call out the Floating menu by touching and holding on the screen with two fingers.



Touch to return to the Home screen, to return to the previous menu or close app, to enter the writing mode and annotate the screen, to capture the screen, to minimize the Floating menu, or to close the Floating menu.

Note:

- ◆ You can customize the app shortcuts in the Floating menu. Touch to open the shortcuts panel. Those shortcuts that are not used in the Floating menu, appear inside the white dashed circles, for example **Meetboard** .

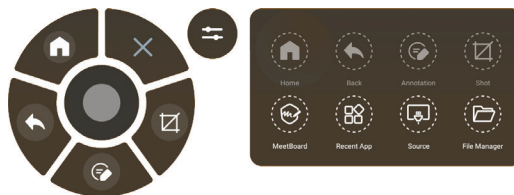

Touch the app shortcut and drag it over the app you want to replace. For example, replace **Screenshot** with **Recent App**.

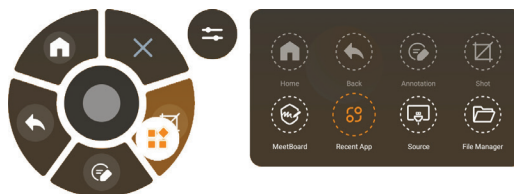

- ◆ Default shortcuts: **Home** , **Back** , and **Exit** cannot be replaced.
- Drag the slider to the left to decrease volume or to the right to increase volume.



Note:

- ◆ You can also adjust the volume by pressing the **—** and **+** button on the remote control.

USING THE SYSTEM

Touch  to mute volume.





Note:

- ◆ You can also mute volume by pressing the  button on the remote control.
- Drag the slider to the left to decrease the screen brightness or to the right to increase the brightness.



Touch  to adjust the screen brightness automatically based on the ambient light sensor reading.



- Recent tasks menu displays the latest apps that you have opened on the interactive display and are currently running in the background. Swipe to the left or to the right to see all apps. To open the app on the screen, simply touch the app icon. To close the app, touch  in the app window or touch  to close all opened apps.

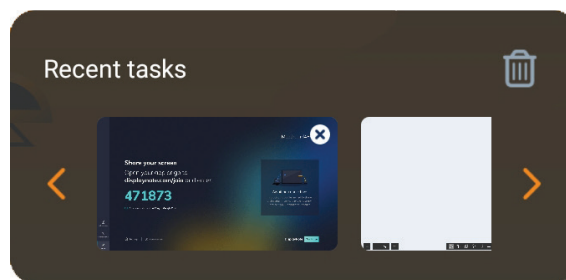





USING THE SYSTEM

4.3 Configuring System Settings

In Settings menu, you can configure various system settings.

To access the Settings menu, do the following:

- 1 On the Home screen, touch  > , press  in the Sidebar menu, or press  on the remote control.

The Settings menu opens.

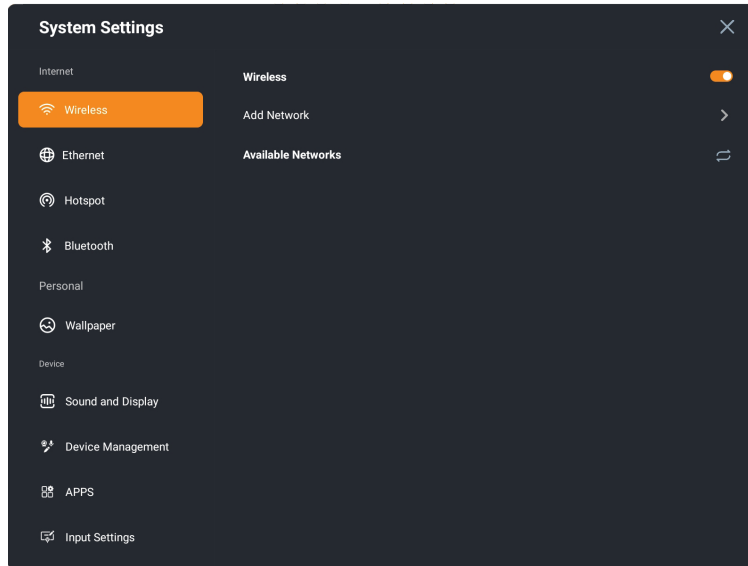

- 2 Configure the following settings based on your needs:

Internet:

- **Wireless:** Connect to an available wireless access point. Enter the access password if prompted.
- **Ethernet:** Connect to LAN through a wired connection.
- **Hotspot:** Provide internet to other devices through your Wi-Fi connection.
- **Bluetooth:** Connect to nearby Bluetooth devices.

Personal:

- **Wallpaper:** Select a wallpaper for the Home screen and configure the wallpaper shuffling settings.

Device:

- **Sound and Display > Picture Setting:** Select a predefined picture mode or customize picture settings manually.
- **Sound and Display > Sound Setting:** Select a predefined sound mode or customize sound settings manually.
- **Device Management > Microphone:** Enable or disable microphone.
- **Device Management > Camera:** Enable or disable camera and AI features.
- **Device Management > Active pen:** Pair an active pen. For more information, refer to “1.8 Using the Active Pen” on page 23.

USING THE SYSTEM

- **APPS > Downloaded Apps:** View and manage downloaded apps.
- **APPS > System Apps:** View and manage system apps.
- **APPS > App Permissions:** Configure app permissions.
- **Input Settings > Source Rename:** Rename input sources. Select the source, enter the new name at the prompt and then touch **CONFIRM** to save the modification, **RESET** to reset to the default setting, or **CANCEL** to discard the modification.

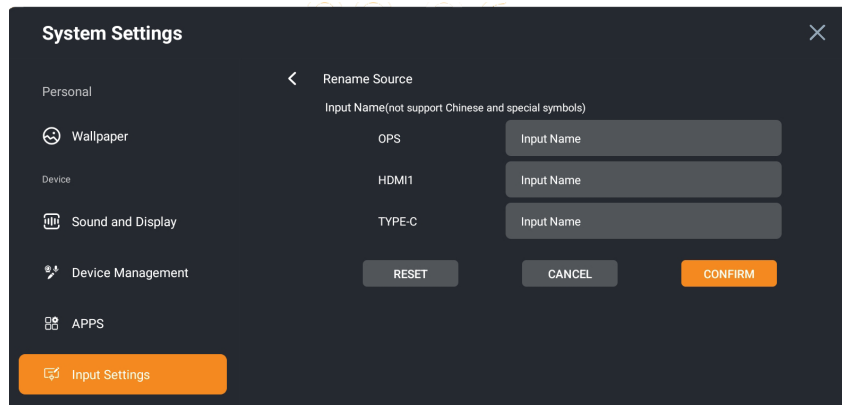

System:

- **Power Settings:** Configure power settings.

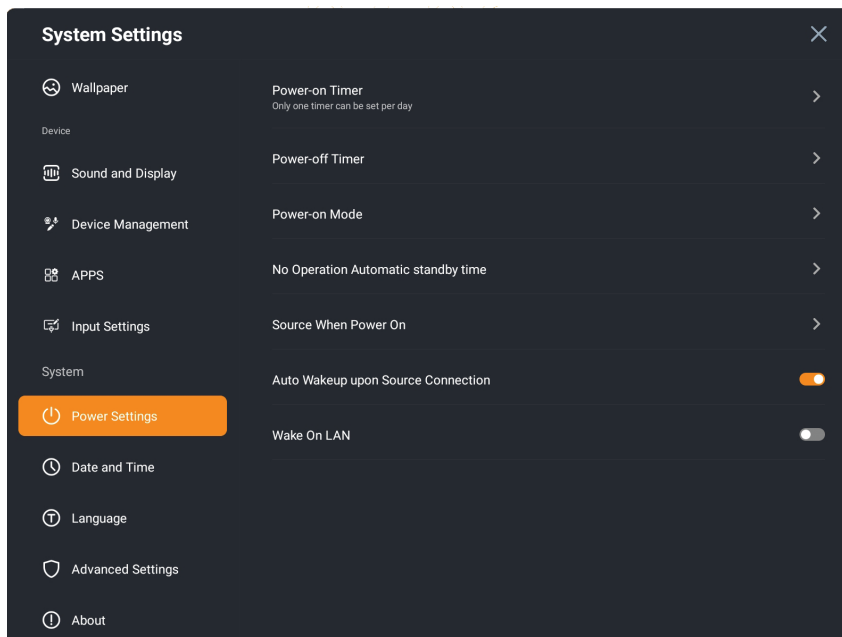

- **Power Settings > Power-on Timer:** Set the power-on time for each day of the week.
- **Power Settings > Power-off Timer:** Set the power-off time for each day of the week.
- **Power Settings > Power-on Mode:** Select the power-on mode between **Power-on**, **Power-on Standby**, and **Power-on Memory**.
- **Power Settings > No Operation Automatic standby time:** Select the period of time of inactivity when the interactive display enters the standby mode.
- **Power Settings > Source When Power On:** Select the default startup source between **Android**, **OPS**, **HDMI**, **TYPE-C**, and **Last Source**.

USING THE SYSTEM

- **Power Settings > Auto Wakeup upon Source Connection:** Enable or disable the interactive display to start up automatically when it detects an active signal source.

- **Power Settings > Wake On LAN:** Enable or disable the interactive display to be turned on or awakened by a network message.

Note:

◆ To use Wake On LAN, ensure that the interactive display is connected to LAN and the network settings are configured properly.

- **Date and Time:** Configure the date and time settings.

- **Language:** Select the system language and input method.

- **Advanced Settings:** To access the Advanced Settings, you need to create a password. Enter the 6-digit password at the prompt and touch FINISH.

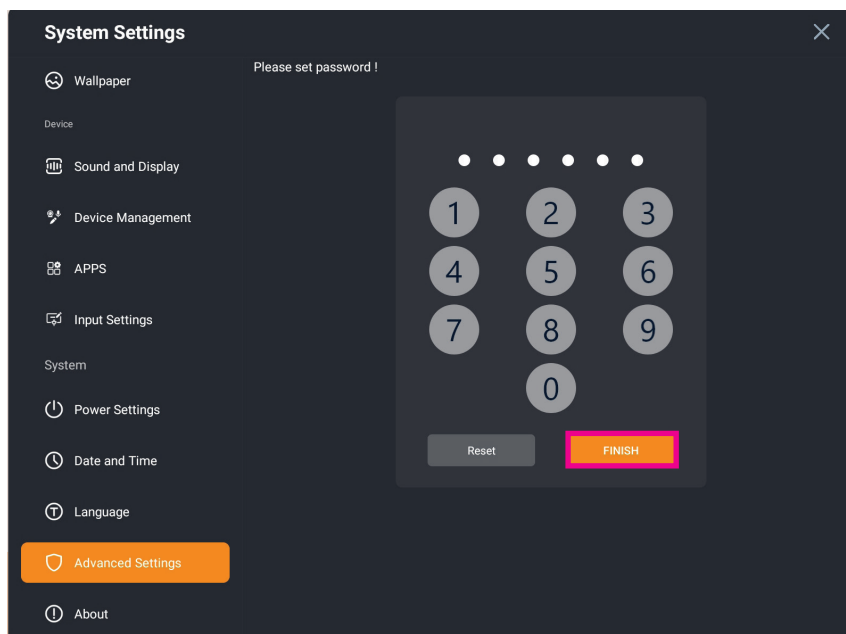

USING THE SYSTEM

Note:

- ◆ If you forgot the password, touch **forgot password** and enter the Superpassword at the prompt. Then touch **Reset** and set a new password for Advanced Settings.

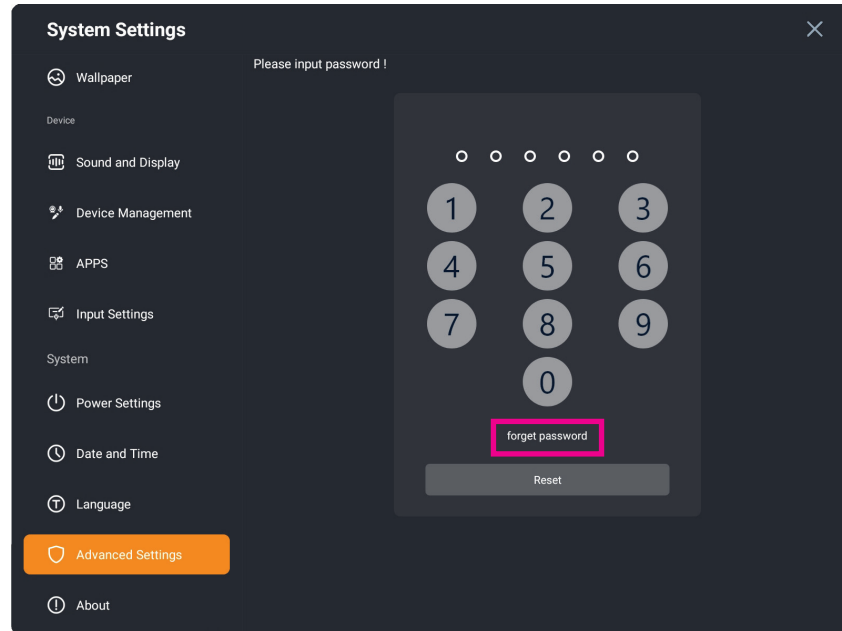

- **Advanced Settings > Application Permissions:** Select the apps that are allowed to use the microphone and/or camera.
- **Advanced Settings > USB Lock:** Enable or disable access to the external devices that are plugged into the USB ports of the interactive display. For example, flash disk.
- **Advanced Settings > HomePage mode:** Select your preferred Home page mode between **EDLA** and **ODM**.

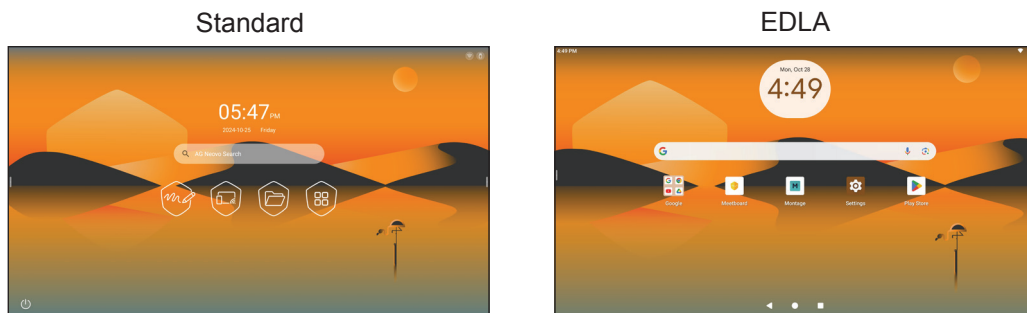

- **Advanced Settings > Restrict App Installation:** Enable or disable installing 3rd party apps to the interactive display.
- **Advanced Settings > Refresh Screen:** Select the screen refresh interval.

USING THE SYSTEM

- **Advanced Settings > Restore factory settings:** Delete all custom actions and restore the system to factory default. Touch **Reset** and then touch **CONFIRM** at the prompt to proceed with resetting the system.

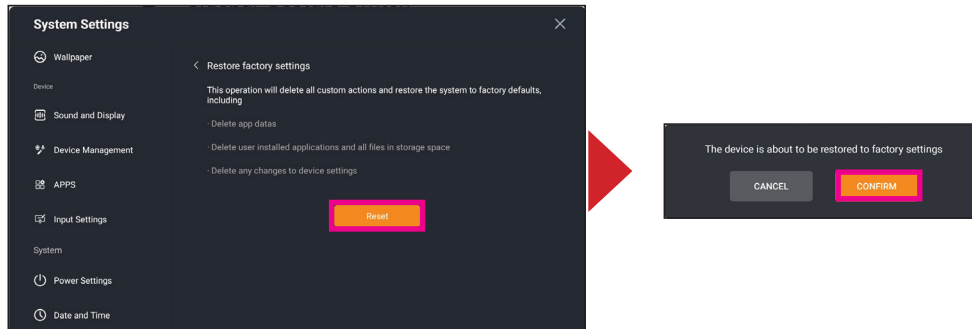

- **Advanced Settings > SAMBA:** Enable or disable the SAMBA service.
- **About:** View and modify device name, view device model, serial model, available storage, Android version, system version, touch frame version, touch driver version, and running time.

CHAPTER 5: USING THE APPS

5.1 Accessing Apps

Some apps, such as **Meetboard**, **Montage**, and **File Manager** are accessible directly from the Home screen. Other apps that are installed on the interactive panel, can be accessed through the Apps screen.

To access the Apps screen, do the following:

- 1 On the Home screen, touch .

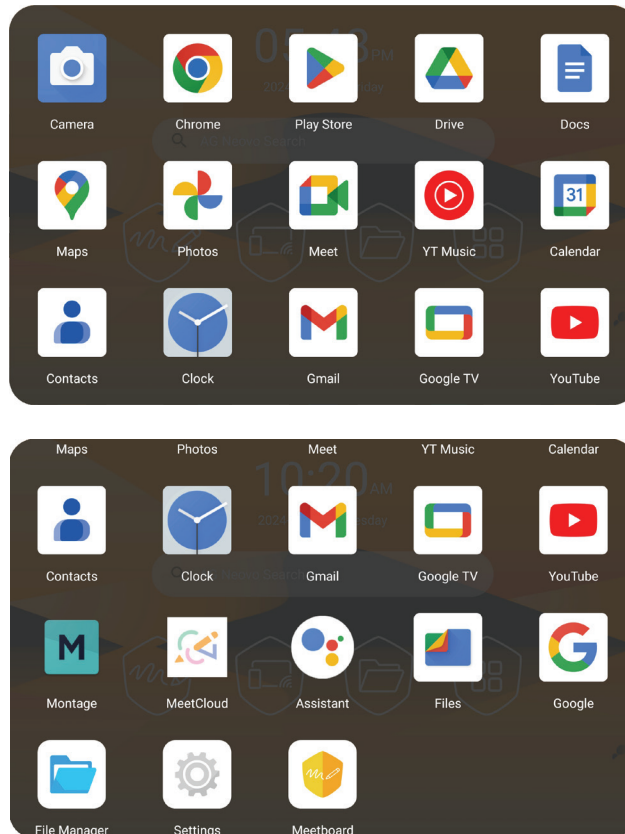



- 2 Swipe the Apps screen up or down to see all apps. To open an app, simply touch the app icon.

5.2 Meetboard

Meetboard is an interactive app that enables you to write and draw images on the display to demonstrate your ideas. The screen image can be saved to the device memory, connected portable disk, easily shared via QR code or email.



USING THE APPS

To use **Meetboard**, do the following:

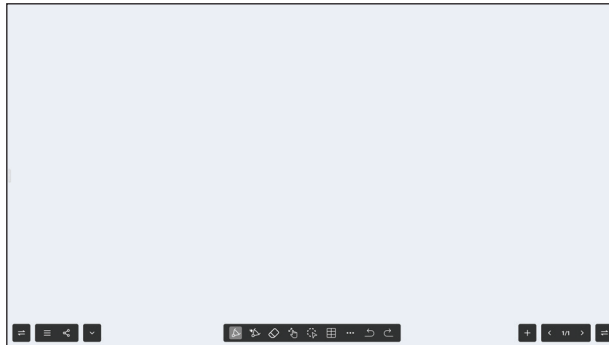
- 1 Touch  on the Home screen, press  on the remote control, or while on the Home screen, remove the touch or active pen from its magnetic placement on the front panel. **Meetboard** opens.



Note:

- ◆ To hide all the controls on the whiteboard, touch . To unhide, touch .
- ◆ To swap the locations of the menu and the page manager, touch .

- 2 Write or draw directly on the whiteboard with the default settings for pen tip type (bottom & top tip), thickness, font color, and background color or touch any of the following icons to modify the default settings:

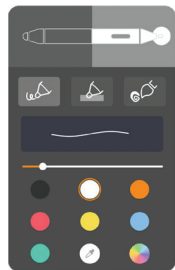

-  **Pen:** Sets the pen type, tip, thickness, and font color for top tip and bottom tip.

Bottom tip options



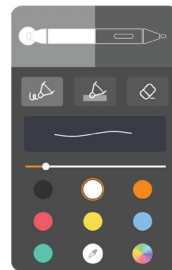





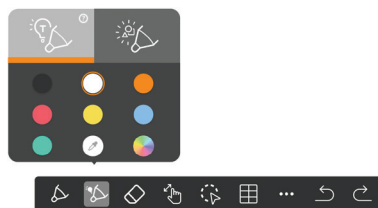



Top tip options





-  **AI:** Automatically detects the written text () or drawn shape () and digitize it. You can also change the text or shape color.







-  **Eraser:** Deletes areas of your written text or shapes.
-  **Single/Multi:** Switch between single and multiple touch points. In single touch mode, it supports two or three-finger gesture controls. In multi-touch mode, it allows multiple fingers or pens to write simultaneously.
-  **Select:** Selects your writing or drawing on the screen. You can then relocate it, rotate, zoom in/out, delete () , copy/paste () , search internet () , flip () it right () or down () , and change color () .

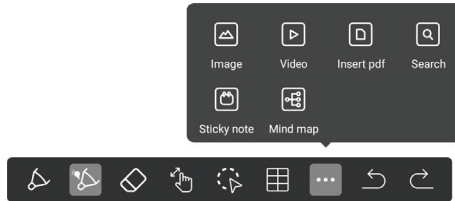

USING THE APPS



-  **Table**: Insert a table.
-  **Tools**: Open more tools and use them based on your needs:

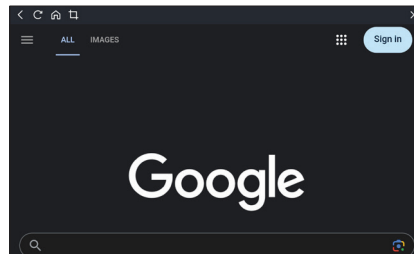



-  **Image**: Import an image.
-  **Video**: Import a video.
-  **Insert pdf**: Import a PDF file.
-  **Search**: Add a fully functional web browser and search internet.

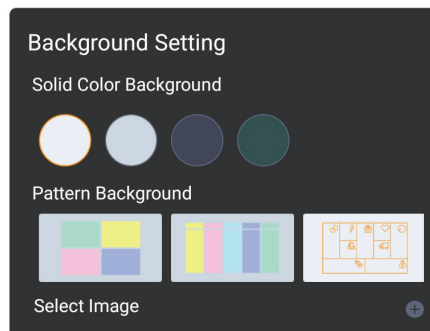

-  **Sticky note**: Add a sticky note.
 -  **Mind map**: Add a diagram.
-  **Undo/Redo**: Undo or redo modifications respectively.

- 3 Touch  **Menu** >  **Background Setting** to change the background of the screen. Select the background color, pattern, or upload your own background.



- 4 Touch  **Menu** >  **Import Note** to import a note to the whiteboard.
- 5 To add a new page, touch + **Add** in the page manager. You can also view all the pages of the session, move to a specific page, or delete an unnecessary page by touching **Select delete** or to delete all pages, touch **Delete all** in the page manager.

USING THE APPS

- 6 Touch **Menu** > **Save** to save the session. Name the session, select the format, path and page that you want to save, and touch **Save**.

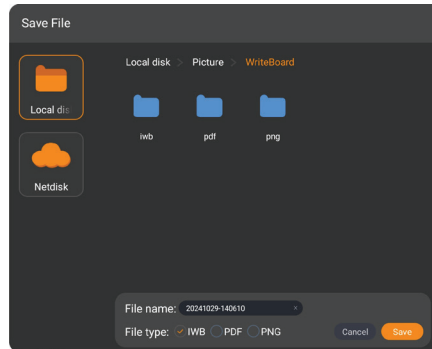

- 7 Touch **Menu** > **Set as Default** to save the current session parameters as a template for future sessions, including the pen color, thickness, background color, and more.

- 8 Touch **Share** to share the session.

- **Code share:** By default is displayed a QR code that shares the entire session to the participants who are connected to the same Wi-Fi network as the interactive display. You can check **shared only current page** to share the current page, **Switch Lan sharing** to share the session over LAN, and **encryption** to encrypt the session (if necessary).

Note:

- ◆ If you want to encrypt the session, then you are prompted to enter a pin code or use a randomly generated code. Touch **Confirm** to complete the procedure.

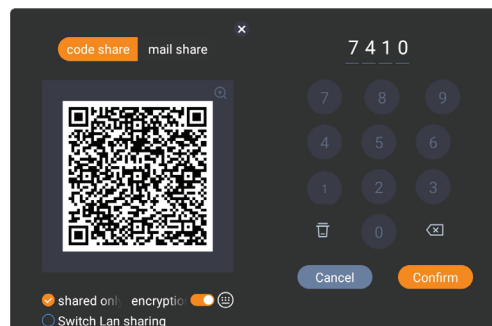

- **Mail share:** Send the session by email. Fill out the required fields and touch **Confirm**. The session is attached as a PDF file.

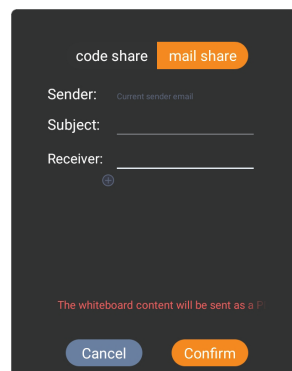

- 9 Touch **Menu** > **Exit** to close **Meetboard**.

USING THE APPS

5.3 Montage

Montage app enables to mirror the display's screen on your portable device for hands-on annotation, mirror the screen of your device on the display, or use your device as a remote control for the display.

Montage is accessible by downloading the **DisplayNote** app to your portable device or using the **DisplayNote** web app over a Chromium web browser. For sharing the screen of your portable device to the interactive display, use **AirPlay**, **Miracast**, or **Google Cast**.

Note:

- ◆ **DisplayNote** app is available for Windows, Mac, iOS, and Android operating systems.
- ◆ For the first-time setup of **Miracast**, please disconnect from any Wi-Fi networks but keep Wi-Fi enabled. Then, go to **Settings > Network & Connections** in **Montage** to turn on the Miracast receiver. Finally, reconnect to your Wi-Fi network.

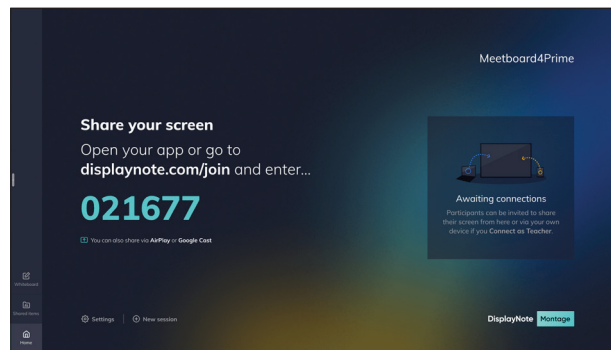

To start casting the screen, do the following:

- 1 Install **DisplayNote** on your portable device or skip this step if you intend to use **DisplayNote** web app over a web browser.
- 2 Ensure that the interactive display is connected to the network and your portable device is connected to the same network.
- 3 On the Home screen, touch  to open **Montage**.
The launcher screen opens:



- 4 Touch any of the following items on the launcher screen based on your needs:
 -  **Whiteboard**: Start a shared whiteboard session. During the session, touch **MENU** to access the annotation tools.



-  **Shared items**: View items that are shared with you and share items to other attendees.
-  **Home**: Return to the launcher screen from any other screen.

USING THE APPS

-  **Settings**: Edit the room name, select the interface language, and view the device info.

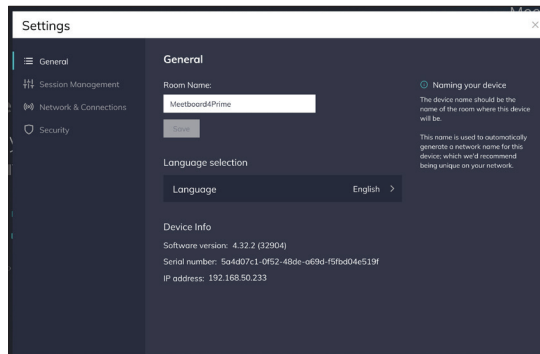

- 5 Launch **DisplayNote** on your portable device or open the web browser and enter “**displaynote.com/join**” without quotation marks and the numeric code that is displayed on the launcher screen. For example, “**021677**”.

Note:

- ◆ The following screenshots are captured from an iOS device when using the **DisplayNote** app.
- 6 Enter the session ID that is displayed on the launcher screen and your name. Then touch **Connect**.

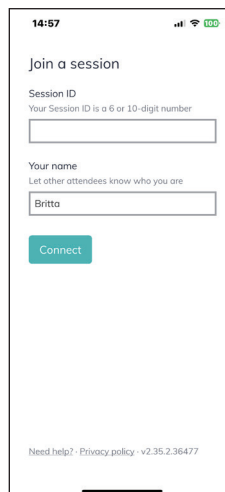

- 7 Touch any of the following:

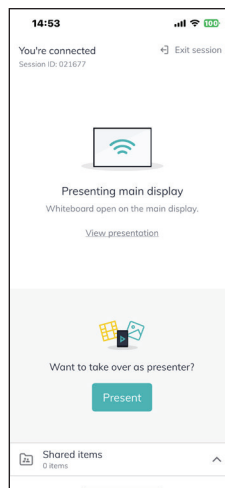

USING THE APPS

- **View presentation:** View the presentation on the main display, annotate the presentation screen, and capture a screenshot.

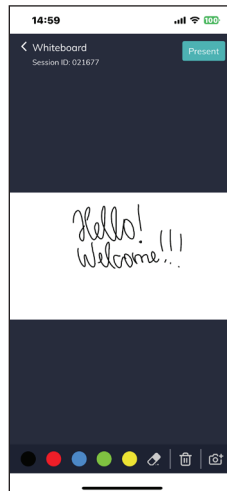

- **Present:** Share your portable device's screen or present a video from the gallery.

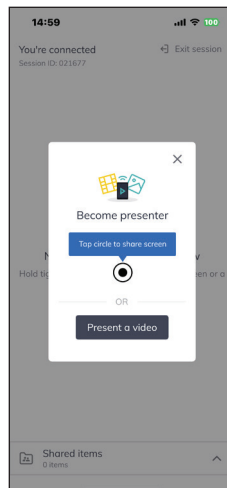

- **Shared items:** View and share items. Touch **+Add items** to upload items for sharing or touch on the item to open it.

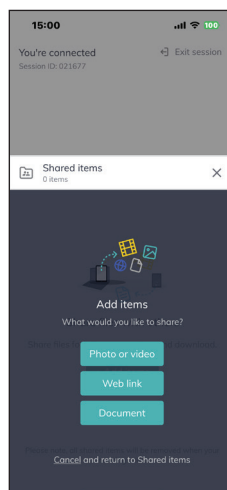







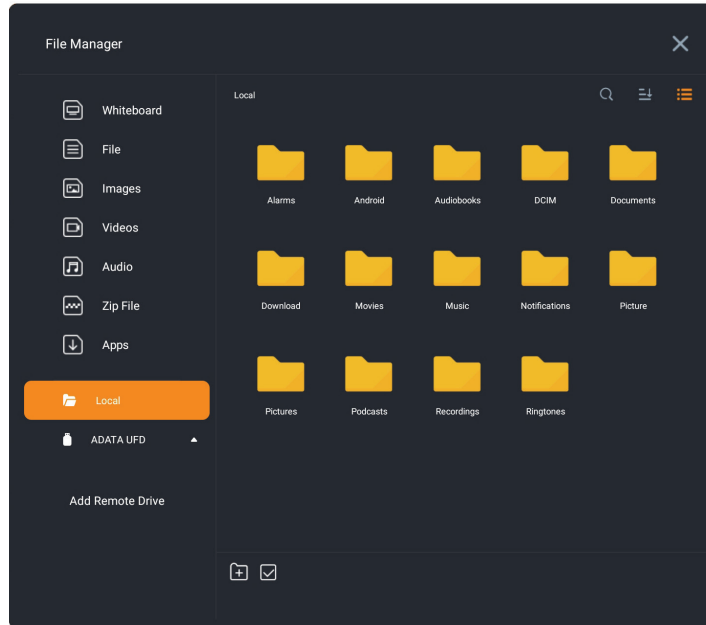





USING THE APPS

5.4 File Manager

File Manager enables you to manage files that are saved to the internal/external memory and to the cloud drive.



To access and manage your files, do the following:

- 1 On the Home screen, touch  to open **File Manager**.
- 2 Do any of the following based on your needs:
 - Touch the storage device on the left panel or touch directly the file category: Whiteboard, File, Images, Videos, Audio, Zip File, Apps that you want to manage.
 - Touch  and enter a keyword to the search bar to look for a file.
 - Touch  and sort the files by name, time, and size.
 - Touch  to view files and folders as list or thumbnails.
 - To open the file, simply touch it. To select file(s), long touch a file first or touch  to enter the selection mode and then select files. If you want to select all files, touch . Then touch  **Copy** or  **Move**, select your preferred file location and touch  **Paste**. Touch  to create a new folder,  to rename the selected file,  to delete the selected file(s), and  to exit the selection mode.

Note:

- ◆ To manage files on your cloud drive, touch .

USING THE APPS

3 To access Samba, ftp, or cloud drive, touch **Add Remote Drive**. Follow the login instructions to access each drive.

- **Samba**: Enter the IP address, username, and password. Then touch **ADD** to access your Samba storage.

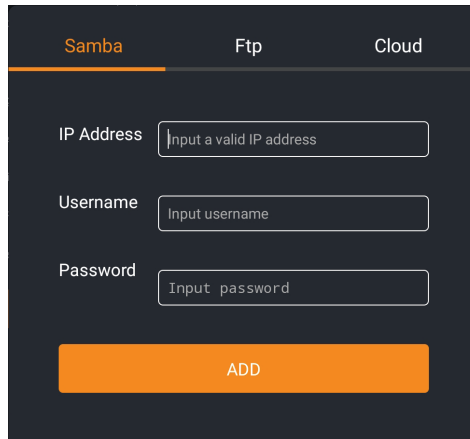

- **Ftp**: Enter the IP address, port, username, and password. Then touch **ADD** to access your FTP storage.

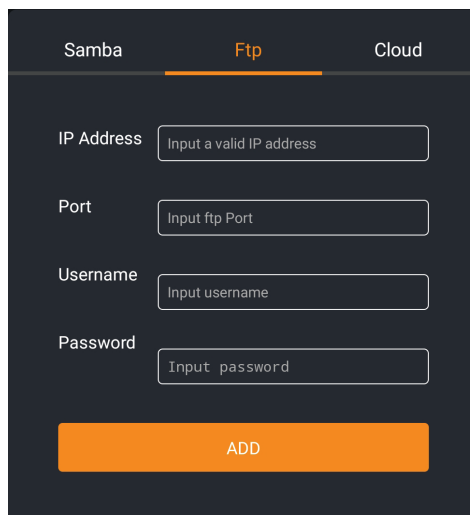

- **Cloud**: Touch either **Google Drive** or **One Drive** and then enter your user credentials at the prompt to log in to your cloud account.

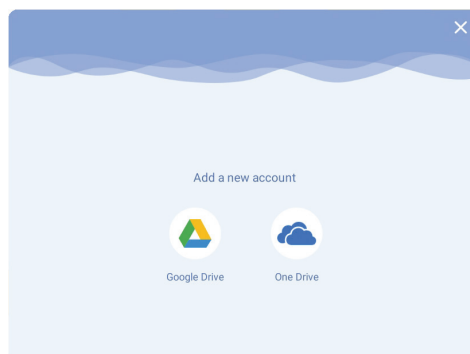

4 Press  to close the File Manager.

USING THE APPS

5.5 Annotation

Choose from a range of various tools with which to annotate the screen. To activate **Annotation**, touch **Sidebar menu**  > **Annotation** or while on any screen except for the Home screen, remove the touch or active pen from its magnetic placement.

Write or draw on the screen directly with your finger or with the touch pen. To change the text or drawing color, share your annotation with others, and more, use any of the following annotation tools based on your needs:

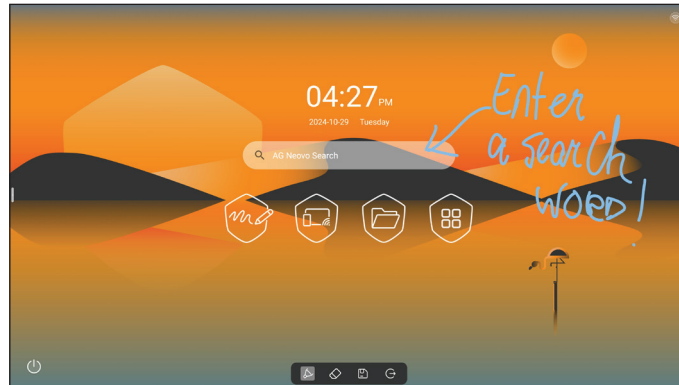





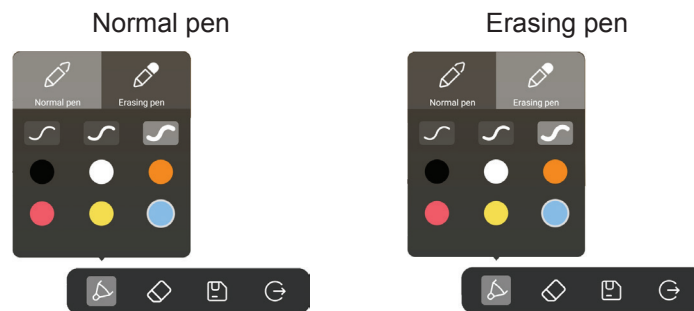

Touch any of the following based on your needs:

- : Set the pen mode (normal pen & erasing pen), thickness, and font color.

Note:

- ◆ In the erasing pen mode, use the bottom of the pen to write/draw and the top of the pen to erase.



- : Delete areas of your written text or shapes.
-  **save file** to save the screen image,  **share code** to share the screen image via QR code, or  **import WhiteBoard** to import the screen image directly to **Meetboard**.
- : Exit the annotation mode.





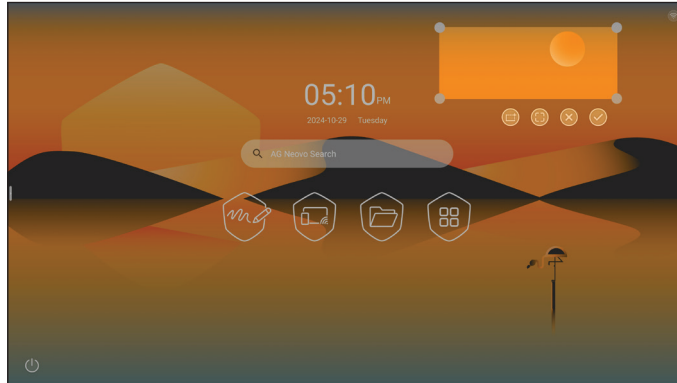

USING THE APPS

5.6 ScreenShot

Capture the screen image. To open **ScreenShot**, touch **Sidebar menu**  > **ScreenShot**.



To capture the screen, do the following:

- 1 Select an area on the screen that you want to capture. By default, you can capture a rectangular area. To use a freehand selection tool, touch . To switch back to the rectangular area selection tool, touch . To capture the entire screen, touch . To switch back to the rectangular area selection tool, touch .
- 2 Touch  to capture the screen image of the selected area.
- 3 Touch  to exit **ScreenShot**.

5.7 Camera



This interactive display is equipped with a built-in webcam for holding online sessions and capturing photos.

To open **Camera**, touch  > **Camera**.



Touch  to capture the photo. After capturing the photo, touch the thumbnail on the screen to view the photo.

Note:

- ◆ To set the self-timer and display a grid, touch .
 - Touch  to display or hide the grid on the screen.
 - Touch  to set the self-timer to 3 seconds, 10 seconds, or disable the self-timer.

CHAPTER 6: APPENDIX

6.1 Warning Messages

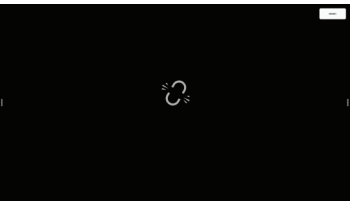
Warning Messages	Cause	Solution
	The interactive display cannot detect the input source signal.	<ul style="list-style-type: none"> • Check if the input source is turned ON. • Check if the signal cable is properly connected. • Check if any pin inside the cable connector is twisted or broken.

6.2 Supported Media Formats

Video Format

File Extensions	Codec		
	Video	Audio	Maximum Transmit Ratio
.3gp/3GP2	mpeg1/2	Mpeg1/2 Layer1/2/3, AACLC, vorbis, LPCM, AMR-NB	Spec: Max Solution: 1920 x 1080 60 Fps, 80 Mbps
	Mpeg-4		
	H.263		Spec: Max Solution: 8192 x 4320 60 Fps, 200 Mbps
	H.264		
	Mjpeg		
vp8	Spec: Max Solution: 1920 x 1080 60 Fps, 60 Mbps		
.asf/asx	mpeg1/2	Mpeg1/2 Layer1/2/3, AACLC, vorbis, LPCM, AMR-NB	Spec: Max Solution: 1920 x 1080 60 Fps, 80 Mbps
	Mpeg-4		
	H.263		Spec: Max Solution: 8192 x 4320 60 Fps, 200 Mbps
	H.264		
.avi	H.265	Mpeg1/2 Layer1/2/3, AACLC, vorbis, LPCM, AMR-NB	Spec: Max Solution: 8192 x 4320 60 Fps, 200 Mbps
	mpeg1/2		Spec: Max Solution: 1920 x 1080 60 Fps, 80 Mbps
	Mpeg-4		Spec: Max Solution: 8192 x 4320 60 Fps, 200 Mbps
	H.263		
	H.264		
	Mjpeg		Spec: Max Solution: 1920 x 1080 30 Fps, 30 Mbps
	vp8		Spec: Max Solution: 1920 x 1080 60 Fps, 60 Mbps
.dat	mpeg1/2	Mpeg1/2 Layer1/2/3, AACLC, LPCM	Spec: Max Solution: 1920 x 1080 60 Fps, 80 Mbps
	Mpeg-4		
	H.264		Spec: Max Solution: 8192 x 4320 60 Fps, 200 Mbps

APPENDIX

File Extensions	Codec		
	Video	Audio	Maximum Transmit Ratio
.flv	H.265	Mpeg1/2 Layer1/2/3, AACLC, LPCM	Spec: Max Solution: 8192 x 4320 60 Fps, 200 Mbps
	Mpeg-4		Spec: Max Solution: 1920 x 1080 60 Fps, 80 Mbps
	H.263		
	H.264		Spec: Max Solution: 8192 x 4320 60 Fps, 200 Mbps
	Mjpeg		Spec: Max Solution: 1920 x 1080 30 Fps, 30 Mbps
	vp8		Spec: Max Solution: 1920 x 1080 60 Fps, 60 Mbps
.mkv	vp9	Mpeg1/2 Layer1/2/3, AACLC, LPCM, opus	Spec: Max Solution: 8192 x 4320 30 Fps, 60 Mbps
	H.265		Spec: Max Solution: 8192 x 4320 60 Fps, 200 Mbps
	mpeg1/2		Spec: Max Solution: 1920 x 1080 60 Fps, 80 Mbps
	Mpeg-4		
	H.264		Spec: Max Solution: 3840 x 2160 30 Fps, 160 Mbps
	Mjpeg		Spec: Max Solution: 1920 x 1080 30 Fps, 30 Mbps
	vp8		Spec: Max Solution: 1920 x 1080 60 Fps, 60 Mbps
.mov	H.265	Mpeg1/2 Layer1/2/3, AACLC, vorbis, LPCM, AMR-NB	Spec: Max Solution: 8192 x 4320 60 Fps, 200 Mbps
	mpeg1/2		Spec: Max Solution: 1920 x 1080 60 Fps, 80 Mbps
	Mpeg-4		
	H.263		
	H.264		Spec: Max Solution: 8192 x 4320 60 Fps, 200 Mbps
	Mjpeg		Spec: Max Solution: 1920 x 1080 30 Fps, 30 Mbps
	vp8		Spec: Max Solution: 1920 x 1080 60 Fps, 60 Mbps
.mp4	H.265	Mpeg1/2 Layer1/2/3, AACLC, vorbis, LPCM, AMR-NB	Spec: Max Solution: 8192 x 4320 60 Fps, 200 Mbps
	mpeg1/2		Spec: Max Solution: 1920 x 1080 60 Fps, 80 Mbps
	Mpeg-4		
	H.263		
	H.264		Spec: Max Solution: 8192 x 4320 60 Fps, 200 Mbps
	Mjpeg		Spec: Max Solution: 1920 x 1080 30 Fps, 30 Mbps
	vp8		Spec: Max Solution: 1920 x 1080 60 Fps, 60 Mbps
.VOB	mpeg1/2	Mpeg1/2 Layer1/2/3, AACLC, LPCM	Spec: Max Solution: 1920 x 1080 60 Fps, 80 Mbps
	Mpeg-4		Spec: Max Solution: 1920 x 1080 60 Fps, 80 Mbps

APPENDIX

File Extensions	Codec		
	Video	Audio	Maximum Transmit Ratio
.mpg/.mpeg	mpeg1/2	Mpeg1/2 Layer1/2/3, AACLC, LPCM	Spec: Max Solution: 1920 x 1080 60 Fps, 80 Mbps
	Mpeg-4		Spec: Max Solution: 8192 x 4320 60 Fps, 200 Mbps
	H.264		
.webm	vp9	Mpeg1/2 Layer1/2/3, AACLC, LPCM, opus	Spec: Max Solution: 8192 x 4320 30 Fps, 60 Mbps
	H.265		Spec: Max Solution: 8192 x 4320 60 Fps, 200 Mbps
	mpeg1/2		Spec: Max Solution: 1920 x 1080 60 Fps, 80 Mbps
	Mpeg-4		Spec: Max Solution: 8192 x 4320 60 Fps, 200 Mbps
	H.264		
	Mjpeg		
	vp8		Spec: Max Solution: 1920 x 1080 60 Fps, 60 Mbps
.ts	H.265	Mpeg1/2 Layer1/2/3, AACLC, LPCM	Spec: Max Solution: 8192 x 4320 60 Fps, 200 Mbps
	mpeg1/2		Spec: Max Solution: 1920 x 1080 60 Fps, 80 Mbps
	Mpeg-4		Spec: Max Solution: 8192 x 4320 60 Fps, 200 Mbps
	H.264		

Audio Format

File Extensions	Format	Audio Codec	Supported Range
.aac	AAC	AAC-LC	Sample Rate: 8K-48 KHz
			Bit Rate: 16K-576 Kbps
.ape	Monkey's Audio	Monkey's Audio	Sample Rate: 32, 44.1, 48 KHz
			Bit Rate: 500 Kbps-1.5 Mbps
.flac	FLAC	FLAC	Sample Rate: 8K-192 KHz
			Bit Rate: 128-2304 Kbps
.amr	AMR-NB	AMR-NB	Sample Rate: 8 KHz
			Bit Rate: 4.75-12.2 Kbps
.opus	OPUS	OPUS	Sample Rate: 8K-48 KHz
			Bit Rate: 32K-9612 Kbps
.mp3	MPEG Audio Layer3	MPEG1/2 layer3	Sample Rate: 8K-48 KHz
			Bit Rate: 8-320 Kbps
.ogg	Vorbis	Vorbis	Sample Rate: 6K-48 KHz
			Bit Rate: 8-500 Kbps
.wav	WAV	LPCM	Sample Rate: 6K-192 KHz

APPENDIX

Image Format

File Extensions	Format	Supported Range	Remark
.bmp	BMP	9600 x 6400	The limitation of max resolution depends on DRAM size
.gif	GIF	6400 x 4800	
.jpeg/jpg	JPEG	Base-line 15360 x 8640	
		Progressive 1024 x 768	
.png	PNG	9600 x 6400	

Note:

- ◆ Sound or video may not work if the contents have a standard bit rate/frame rate above the compatible Frame/sec listed in the table above.
- ◆ Video content with a Bit rate or Frame rate larger than the rate specified in the table above can cause choppy video during playback.

6.3 Supported Resolution

Signal Timing	Reference	Clock Frequency	Horizontal Frequency	Vertical Frequency	HDMI	USB-C
		MHz	KHz	Hz		
720 x 400 @70Hz	IBM	28.322	31.788	70	—	—
640 x 480 @60Hz	VESA	25.18	31.469	59.94	√	√
800 x 600 @56Hz	VESA	36	35.156	56.25	√	√
800 x 600 @60Hz	VESA	40	37.879	60.317	√	√
1024 x 768 @60Hz	VESA	65	48.363	60.004	√	√
1280 x 768 @60Hz(RB)	CVTRB	68.25	47.396	59.995	√	√
1280 x 768 @60Hz	VESA	79.5	47.776	59.87	√	√
1280 x 800 @60Hz	VESA	83.5	49.702	59.81	√	√
1280 x 960 @60.000Hz	VESA	108	60	60	√	√
1280 x 1024 @60Hz	VESA	108	63.981	60.002	√	√
1360 x 768 @60Hz	VESA	85.5	47.712	60.015	√	√
1440 x 900 @60Hz(RB)	CVTRB	88.75	55.469	59.901	√	√
1440 x 900 @60Hz	CVT	106.5	55.935	59.887	√	√
1680 x 1050 60Hz	VESA	146.25	65.29	59.954	√	√
1920 x 1080 60Hz	CEA	148.5	67.5	60	√	√
640 x 480P594:3	CEA	25.175	31.469	59.94	—	√
640 x 480P604:3	CEA	25.2	31.5	60	—	√
720 x 480P604:3	CEA	27.027	31.5	60	—	√
720 x 480P6016:9	CEA	27.027	31.5	60	—	√
1280 x 720P5916:9	CEA	74.175	44.955	59.939	—	√
1280 x 720P6016:9	CEA	74.25	45	60	—	√
1440 x 480P604:3	CEA	54.054	31.5	60	—	√
1440 x 480P5916:9	CEA	54	31.469	59.94	—	√
1440 x 480P6016:9	CEA	54.054	31.5	60	—	√
1920 x 1080P5916:9	CEA	148.35	67.432	59.939	—	√

APPENDIX

Signal Timing	Reference	Clock Frequency	Horizontal Frequency	Vertical Frequency	HDMI	USB-C
		MHz	KHz	Hz		
1920 x 1080P6016:9	CEA	148.5	67.5	60	—	√
720 x 576P504:3	CEA	27	31.25	50	—	√
720 x 576P5016:9	CEA	27	31.25	50	—	√
1280 x 720P5016:9	CEA	74.25	37.5	50	—	√
1440 x 576P5016:9	CEA	54	31.25	50	—	√
1920 x 1080P5016:9	CEA	148.5	56.25	50	—	√
1920 x 1080P2316:9	CEA	74.175	26.973	23.976	—	√
1920 x 1080P2416:9	CEA	74.25	27	24	—	√
1920 x 1080P2516:9	CEA	74.25	28.125	25	—	√
1920 x 1080P2916:9	CEA	74.175	33.716	29.97	—	√
1920 x 1080P3016:9	CEA	74.25	33.75	30	—	√
720(1440) x 480i	CEA	27	15.734	59.939	√	—
480p 59Hz	CEA	27	31.469	59.94	√	—
480p 60Hz	CEA	27.027	31.5	60	√	—
720(1440) x 576i	CEA	27	15.625	50	√	—
576p 50Hz	CEA	27	31.25	50	√	—
720p 60Hz	CEA	74.25	45	60	√	—
720p 59Hz	CEA	74.176	44.955	59.94	√	—
720p 50Hz	CEA	74.25	37.5	50	√	—
1080i 60Hz	CEA	74.25	33.75	60	√	—
1080i 59Hz	CEA	74.176	33.716	59.94	√	—
1080i 50Hz	CEA	74.25	28.125	50	√	—
1080p 60Hz	CEA	148.5	67.5	60	√	—
1080p 50Hz	CEA	148.5	56.25	50	√	—
1080p 30Hz	CEA	74.25	33.75	30	√	—
1080p 29Hz	CEA	74.176	33.716	29.97	√	—
1080p 25Hz	CEA	74.25	28.125	25	√	—
1080p 24Hz	CEA	74.25	27	24	√	—
1080p 23Hz	CEA	74.176	26.973	23.976	√	—
3840 x 2160 60Hz	CEA	594	135	60	√	√
3840 x 2160 50Hz	CEA	594	112.5	50	√	√
3840 x 2160 30Hz	CEA	297	67.5	29.97	√	√
3840 x 2160 25Hz	CEA	297	56.25	25	√	√
3840 x*2160 24Hz	CEA	297	54	23.982	√	√

APPENDIX

6.4 Troubleshooting

Symptom	Possible Cause	Remedy
No picture is displayed	<ul style="list-style-type: none"> The power cord has been disconnected. The main power switch on the bottom of the display is not switched on. The selected input has no connection. The display is in standby mode. 	<ol style="list-style-type: none"> 1 Plug in the power cord. 2 Make sure the power switch is switched on. 3 Connect a signal connection to the display.
Interference displayed on the display or audible noise is heard	Caused by surrounding electrical appliances or fluorescent lights.	Move the display to another location to see if the interference is reduced or connect the display to another power outlet.
Color is abnormal	The signal cable is not connected properly.	Make sure that the signal cable is attached firmly to the display.
Picture is distorted with abnormal patterns	<ul style="list-style-type: none"> The signal cable is not connected properly. The input signal is beyond the capabilities of the display. 	<ul style="list-style-type: none"> Make sure that the signal cable is attached firmly. Check the video signal source to see if it is beyond the range of the display. Please verify its specifications with this display's specification section.
Display image doesn't fill up the full size of the screen	The picture format is not set correctly.	Open the Source menu and try the different aspect ratio formats. Refer to the "3.2 Selecting the Input Source Signal" section.
Can hear sound, but no picture	Improperly connected source signal cable.	Make sure that both video inputs and sound inputs are correctly connected.
Can see picture but no sound is heard	<ul style="list-style-type: none"> Improperly connected source signal cable. Volume is turned all the way down. Mute function is turned on. No external speaker connected. 	<ul style="list-style-type: none"> Make sure that both video and sound inputs are correctly connected. Press the \oplus button on the remote control to hear the sound. Switch the mute function off by pressing the \otimes button on the remote control. Connect the external speakers and adjust the volume to a suitable level.
Some picture elements do not light up	Some pixels of the display may not turn on.	This display is manufactured using an extremely high level of precision technology: however, sometimes some pixels of the display may not display. This is not a malfunction.
The response of the system is slow or the system crashes	<ul style="list-style-type: none"> Too many apps are running in the background. The normal operation of the system is disturbed by the environmental conditions, for example thunderstorm. 	Disconnect your interactive display from the power outlet and wait for 1-2 minutes. Then reconnect the power cable and restart the display.

APPENDIX

Symptom	Possible Cause	Remedy
The touch response is slow and not functioning	Too many apps are running in the background.	<ul style="list-style-type: none">• Close the apps that you are not using.• Restart the system.
The touch response is slow and not functioning	Too many apps are running in the background.	<ul style="list-style-type: none">• Close the apps that you are not using.• Restart the system.
Cannot connect to Wi-Fi	Wi-Fi module is not installed to the interactive display or is not installed correctly.	(Re)install the Wi-Fi module to the interactive display. Refer to page 21.

CHAPTER 7: SPECIFICATIONS

7.1 Display Specifications

		IFP6504P-AO	IFP7504P-AO	IFP8604P-AO
Panel	Panel Type	LED-Backlit TFT LCD (IPS Technology)	LED-Backlit TFT LCD (IPS Technology)	LED-Backlit TFT LCD (IPS Technology)
	Panel Size	64.5"	74.5"	85.6"
	Max. Resolution	UHD 3840 x 2160	UHD 3840 x 2160	UHD 3840 x 2160
	Pixel Pitch	0.372 mm	0.430 mm	0.494mm
	Brightness	400 cd/m ²	400 cd/m ²	400 cd/m ²
	Contrast Ratio	1200:1	1200:1	1200:1
	Viewing Angle (H/V)	178°/178°	178°/178°	178°/178°
	Display Colour	1.07G colors (10bits).	1.07G colors (10bits).	1.07G colors (10bits).
	Response Time	5 ms	5 ms	5 ms
	Surface Treatment	Haze 25%, 2H, Anti-Glare	Haze 25%, 3H, Anti-Glare	Haze 25%, 3H, Anti-Glare
Frequency (H/V)	H Freq.	30 kHz-135 kHz	30 kHz-135 kHz	30 kHz-135 kHz
	V Freq.	30Hz-76Hz	30Hz-76Hz	30Hz-76Hz
Input	HDMI	2.1 x 1	2.1 x 1	2.1 x 1
	Type-C	x 1 (PD:60W)	x 1 (PD:60W)	x 1 (PD:60W)
Output	HDMI	2.1 x 1	2.1 x 1	2.1 x 1
External Control	RS232 In	9-Pin D-Sub	9-Pin D-Sub	9-Pin D-Sub
	LAN (RJ45)	RJ45 x 2	RJ45 x 2	RJ45 x 2
Embedded System	OS	Android 13.0	Android 13.0	Android 13.0
	CPU	Cortex A76+A55	Cortex A76+A55	Cortex A76+A55
	Memory	8G	8G	8G
	Storage	128G	128G	128G
Other Connectivity	USB	USB 3.0 x 5 (Media Playback) Type-C(PD:60W)	USB 3.0 x 5 (Media Playback) Type-C(PD:60W)	USB 3.0 x 5 (Media Playback) Type-C(PD:60W)
	OPS Slot	Yes	Yes	Yes
Audio	Audio Out	S/PDIF	S/PDIF	S/PDIF
	Internal Speakers	15W x 2	15W x 2	15W x 2
Touch Screen	Technology	Infrared Touch Frame	Infrared Touch Frame	Infrared Touch Frame
	Positional Accuracy	±1 mm	±1 mm	±1 mm
	Panel Interface	USB (Type-B)	USB (Type-B)	USB (Type-B)
	Single-touch Plug & Play	Windows 2000/XP/Vista/CE 6.0 macOS	Windows 2000/XP/Vista/CE 6.0 macOS	Windows 2000/XP/Vista/CE 6.0 macOS
	Multi-touch Plug & Play	40 point touch for Windows 7/8/10/11 20 points for Android/Linux (kernel 3.5 above) Chrome 39 or above	40 point touch for Windows 7/8/10/11 20 points for Android/Linux (kernel 3.5 above) Chrome 39 or above	40 point touch for Windows 7/8/10/11 20 points for Android/Linux (kernel 3.5 above) Chrome 39 or above
	Multi-touch Support by Driver	20 point touch for macOS (supported by UPDD driver)	20 point touch for macOS (supported by UPDD driver)	20 point touch for macOS (supported by UPDD driver)
Camera	Resolution	8M	8M	8M
	Pixel	3840x2106(30fps)	3840x2106(30fps)	3840x2106(30fps)
	Microphone	8-Array	8-Array	8-Array
Power	Power Requirements	AC100~240, 50Hz~60Hz	AC100~240, 50Hz~60Hz	AC100~240, 50Hz~60Hz
	On Mode	185W (On)	235W(On)	350W(On)
	On Mode (Max)	390W (Max)	420W (max.)	620W (max.)
	Standby Mode	<0.5W	<0.5W	<0.5W
	Off Mode	0W	0W	0W
	Power Supply	Internal	Internal	Internal
Glass	Thickness	3.2 mm (0.13")	3.2 mm (0.13")	3.2 mm (0.13")
	MOHS Hardness	5	5	5
	Pencil Hardness	8H	8H	8H
	IK Rating	IK08	IK08	IK08
	Gloss	≤0.3 um	≤0.3 um	≤0.3 um
	Haze	3%~8%	3%~8%	3%~8%
Operating Conditions	Temperature	0°C-40°C (32°F-104°F)	0°C-40°C (32°F-104°F)	0°C-40°C (32°F-104°F)
	Humidity	20%-80% (non-condensing)	20%-80% (non-condensing)	20%-80% (non-condensing)

SPECIFICATIONS

		IFP6504P-AO	IFP7504P-AO	IFP8604P-AO
Storage Conditions	Temperature	-10°C-60°C (-14°F-140°F)	-10°C-60°C (-14°F-140°F)	-10°C-60°C (-14°F-140°F)
	Humidity	10%-80% (non-condensing)	10%-80% (non-condensing)	10%-80% (non-condensing)
Mounting	VESA FPM PMI	Yes (600 x 400 mm)	Yes (800 x 400 mm)	Yes (800 x 600 mm)
Dimensions	with Bracket (W x H x D)	1482.1 x 929.9 x 117.5 mm (58.4" x 36.6" x 4.6")	1716.5 x 1062.9 x 123.9 mm (67.6" x 41.8" x 4.9")	1961.8 x 1200.9 x 123.9 mm (77.2" x 47.3" x 4.9")
	without Bracket (W x H x D)	1482.1 x 929.9 x 86.0 mm (58.4" x 36.6" x 3.4")	1716.5 x 1062.9 x 86.0 mm (67.6" x 41.8" x 3.4")	1961.8 x 1200.9 x 86.0 mm (77.2" x 47.3" x 3.4")
	Packaging (W x H x D)	1600.0 x 220.0 x 1045.0 mm (63.0" x 8.7" x 41.1")	1900.0 x 225.0 x 1160.0 mm (74.8" x 8.9" x 45.7")	2160.0 x 225.0 x 1310.0 mm (85.0" x 8.9" x 51.6")
Weight	with Bracket	43.3 kg (95.5 lb)	57.3 kg (126.3 lb)	72.0 kg (158.7 lb)
	without Bracket	40.5 kg (89.3 lb)	50.7 kg (111.8 lb)	68.7 kg (151.4 lb)
	Packaging	49.5 kg (109.1 lb)	65.3 kg (144.0 lb)	81.4 kg (179.5 lb)

Note:

- ◆ All specifications are subject to change without prior notice.

7.2 Display Dimensions

IFP6504P-AO

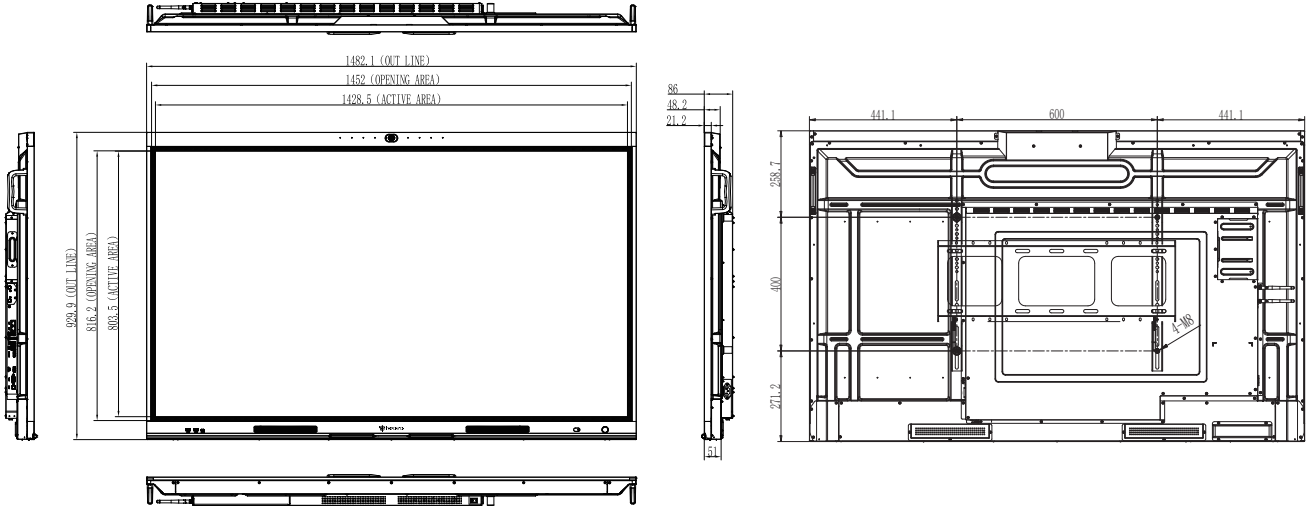

SPECIFICATIONS

IFP7504P-AO

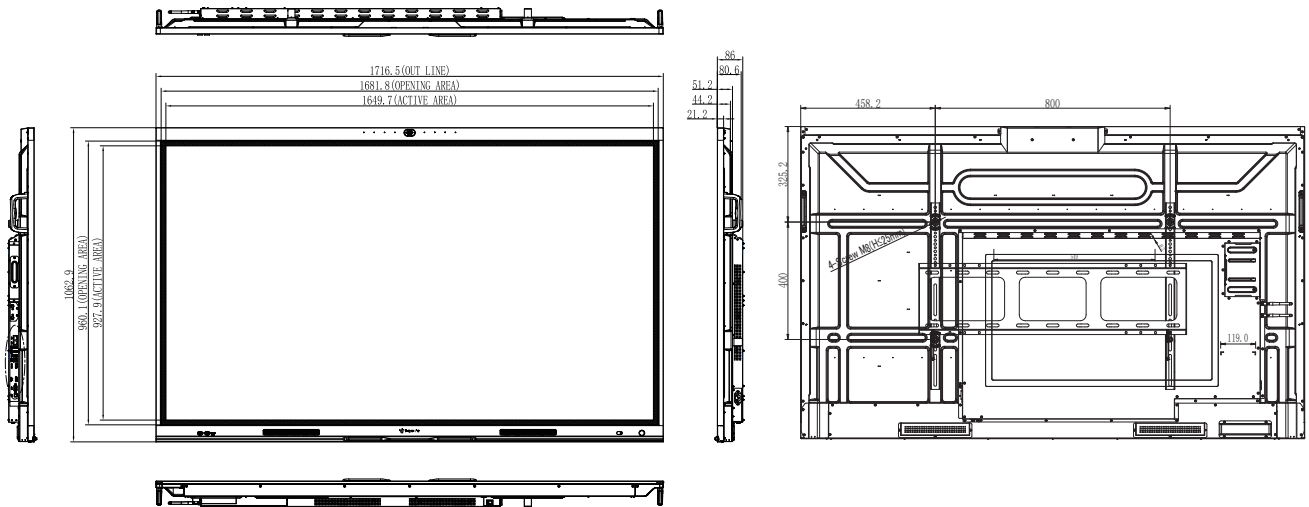

IFP8604P-AO

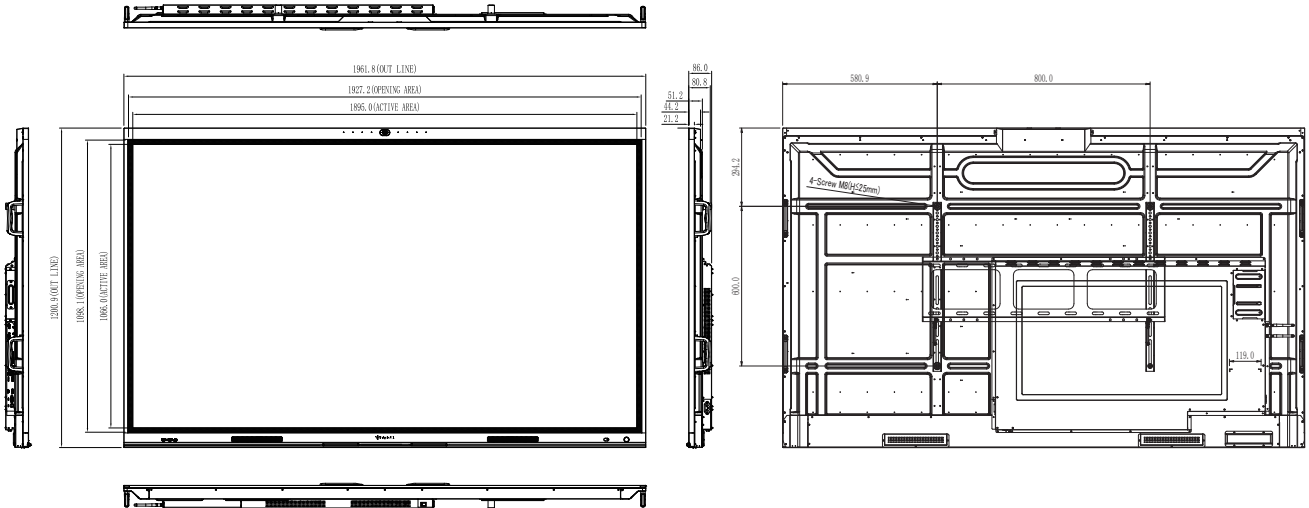

AG Neovo

Company Address: 5F-1, No. 3-1, Park Street, Nangang District, Taipei, 11503, Taiwan.

Copyright © 2024 AG Neovo. All rights reserved.

I64PA0/ I74PA0/ I84PA0_UM_V010